

M O M M A

Models, Optimisation and Mathematical Analysis

J

JOURNAL

SPECIAL ISSUE
SELECTED PAPERS OF IWMA 2012

Editor-in-chief
MOSTEFA BELARBI

Edition Comity

SENOUCI Aek	University of Tiaret- Algeria
Abdelkader CHAIB	Universitaire Centre of Tissemsilt-Algeria
Djamel TURKI	University of Tiaret- Algeria
Halim BENALI	Universitaire Centre of Relizane - Algeria
Khathir BEKKI	University of Tiaret- Algeria
Samir NESSAN	University of Tiaret- Algeria
Aicha LAKHDARI	University of Tiaret- Algeria
Hayat DAOUD	University of Tiaret- Algeria
Sabrina AMAR	University of Tiaret- Algeria
Rekia ALEM	University of Tiaret- Algeria
Chahrazed ADDA	University of Tiaret- Algeria
Abdelhamid HARICHE	University of Tiaret - Algeria

2012

Message of MOMA Journal Editor-In-Chief

This journal will include both national and international scientific researches and will be primarily focused on Models and Optimization of Systems. These systems will be involved in different applications for example, Web technologies, Information Systems, Decision Systems, Embedded Systems, Control-Command Systems and Real-Time Systems. Space of the journal is also dedicated to mathematical analysis like functional spaces, polynomial computing, dynamic systems,...

This second edition is dedicated to the workshop IWMCS'2012 organized by the Ibn Khaldoun University of Tiaret during 16-17 December 2012. IWMCS'2012 Workshop on Mathematics and computer science, discussed Formal approaches and optimization of numerical models.

We have selected ten papers among nineteen accepted submissions of IWMCS'2012.

We would like to express our gratitude to everyone who has contributed towards the success of this edition.

Special thanks to the institution of Ibn Khaldoun University of Tiaret to accept the full publication charges of this second issue.

**Sincerely yours,
Dr. Mostefa BELARBI**

Table of Contents

Message of Editor-In-Chief

Formal Verification of Fault Tolerant NoC-base Architecture

M. Andriamiarina, H.Daoud, M.Belarbi, D.Méry and C.Tanougast..... 01

Cryptanalysis of ciphertext substitution using ACO algorithms

A. Hariche, M. Belarbi and H. Daoud 08

Formal Specification by Coq of Date and Darwen's Object/relational Model

A.Benabbou , S. Nait Bahloul..... 14

Approach for Modelling and verification of flexible and adaptable businesses processes

M.Madani, K. Bekki..... 21

Driver Drowsiness Detection system based on Visual Information

B. Alshaqaqi, A. Baquhaizel and M. Ouis..... 27

Road Traffic Mean Speed Estimation Using a Camera

M. Bekhti, B.Abdelaziz and I. Alshaqaqi..... 32

Automatic Segmentation Approach based Possibility Theory for the Classification of Brain Tissues

L.Chaabane, A. Moussaoui..... 37

Quadratic Programming Method to Solve the N-L Optimization Problems Applied to Energy Management System

F. Benhamida, A. Gras, S. Slimane and A. Bendaoud (Removed)..... 42

New Algorithm to Solve Convex Separable Programming

A.Chikhaoui, B. Djebbar , A. Mokhtari, and A.Belabbaci..... 50

Evaluation of the Dynamic Reliability by Differential Equations

W. Massoum, M.Noureddine..... 56

Formal Verification of Fault Tolerant NoC-base Architecture

Manamiary Bruno Andriamiarina[‡], Hayat Daoud^{*}, Mostefa Belarbi^{*}, Dominique Méry[‡], Camel Tanougast[†]

^{*} IBN Khaldoun University, LIM hayat.daoud@hotmail.fr master.dept.inf@gmail.com

[†]Université de Lorraine University, LICM, ISEA
camel.tanougast@{univ-metz, univ-lorraine}.fr

[‡]Université de Lorraine University, LORIA Vandœuvre-lès-Nancy, France dominique.mery@{loria, univ-lorraine}.fr

Abstract—Approaches to design fault tolerant Network-on-Chip (NoC) for System-on-Chip(SoC)-based reconfigurable Field-Programmable Gate Array (FPGA) technology are challenges on the conceptualisation of the Multiprocessor System-on-Chip (MPSoC) design. For this purpose, the use of rigorous formal approaches, based on incremental design and proof theory, has become an essential step in a validation architecture. The Event-B formal method is a promising formal approach that can be used to develop, model and prove accurately the domain of SoCs and MPSoCs. This paper gives a formal verification of a NoC architecture, using the Event-B methodology. The formalisation process is based on an incremental and validated correct-by-construction development of the NoC architecture.

Keywords-Network on chip, Switch, Adaptive-routing, machine, context, Model, specification, refinement, Formal proof, Correct-by-construction.

I. INTRODUCTION

Designs are usually verified by simulation with created stimuli. This allows the detection of the coarse errors in a design. However, simulation can not find all possible errors in a design. This is why we use formal methods, such as Event-B, and especially the correct-by-construction paradigm [8] for specifying hardware systems. The correct-by-construction paradigm offers an alternative approach to prove and derive correct systems and architectures, through the reconstruction of a target system using stepwise refinement and validated methodological techniques [2, 4, 9]. Our goal is to complement the time consuming simulations in the design flow with a formal proof method. The prerequisites for the formal development of a given microelectronic architecture are the description and/or the design of the architecture.

The dynamic reconfigurable NoC are adequate and appropriate for FPGA-based systems, where the main problem arises when components IPs (Intellectual

Property) must be set dynamically at runtime. Given the rapid changes and increasing complexity of MPSoCs (Multiprocessor System on Chip), constraints of cost and performance, related to the complexity and the increasing number of modules or IPs interconnected, must be solved. Current on-chip communication network implement data packet transmissions between interconnected nodes. Sometimes, communications in these networks are difficult, even impossible. This is the main reason why fault-tolerant XY routing algorithms (for these networks) have been introduced [6]. Routers can control if previous switches have made routing errors (e.g. packet out of the XY path, etc.). Moreover, new adaptive and fault-tolerant routing techniques, with error detection and based on the well known XY and turn model routing schemes [7], have been introduced. Usually, these designs are verified by simulation, which allows the detection of coarse errors. However, simulation alone is not sufficient to improve such architectures [5]. In this article, we use Event-B to specify, verify and prove the behaviour of NoC architectures.

The paper is organized as follows. Section 2 presents an overview of the Event-B approach. Section 3 introduces the studied NoC architecture. Section 4 describes the formal development of the NoC architecture. Section 5 concludes this paper along with the future work.

II. EVENT B: STEPWISE DESIGN OF SYSTEMS

We choose Event B [1] as a modeling language, mainly because of the refinement, which allows a progressive development of models. Event B also is supported by a complete toolset RODIN [10] providing features like refinement, proof obligations generation, proof assistants and model-checking facilities.

The Event B modeling language can express safety properties, which are either invariants, theorems or safety properties in a machine corresponding to the system. The two main structures available in Event B are:

- Contexts express static informations about the model.

- Machines express dynamic informations about the model, invariants, safety properties, and events.

An Event B model is defined either as a context or as a machine. A machine organises events (or actions) modifying state variables and uses static informations defined in a context. The general form of an event is expressed as follows ANY x WHERE G(x, u) THEN u : (P(u, u0)) END and corresponds to the transformation of the state variable u, which is set to a value u0 satisfying the formula $\exists x . G(x, u) \wedge P(u, u0)$, where u is the value of u before the observation of the event. If the set of events is denoted E, then the before-after predicate $BA(e)(x, x0)$, where

e is in E, is the previous formula. Proof obligations (INV 1 and INV 2) are produced by the RODIN tool, from events, to state that an invariant condition I(x) is preserved. Their general form follows immediately from the definitions of the before-after predicate $BA(e)(x, x0)$ of each event e of E and $grd(e)(x)$, which is safety of the guard G(t, x) of event e: (INV1) $I(x) \Rightarrow I(x0)$; (INV2) $I(x) \wedge BA(e)(x, x0) \Rightarrow I(x0)$; (FIS) $I(x) \wedge grd(e)(x) \Rightarrow \exists y . BA(e)(x, y)$.

The proof obligation FIS expresses the feasibility of the event e, with respect to the invariant I. By proving feasibility, we achieve that $BA(e)(x, y)$ provides an after state whenever $grd(e)(x)$ holds. This means that the guard indeed represents the enabling condition of the event.

These basic structures are extended by the refinement of models which provides a mechanism for relating an abstract model and a concrete model by adding new events or variables. This feature allows to develop gradually Event-B models and to validate each decision step using the proof tool. The refinement relationship should be expressed as follows: a model M is refined by a model P, when P simulates M. The final concrete model is close to the behaviour of real system that executes events using real source code. The relationships between contexts, machines and events are illustrated by the next diagrams, which consider refinements of events and machines.

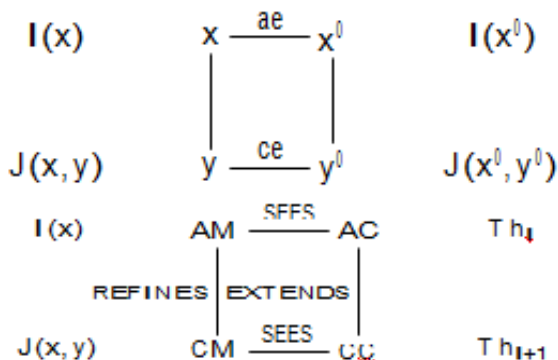

Fig. 1. Machines and Contexts relationships

The refinement of a formal model allows us to enrich the model via a step-by-step approach and is the foundation of our correct-by-construction approach [8]. Refinement provides a way to strengthen invariants and to add details to a model. It is also used to transform an abstract model to a more concrete version by modifying the state description. This is done by extending the list of state variables (possibly suppressing some of them), by refining each abstract event to a set of possible concrete versions, and by adding new events.

We suppose that an abstract model AM with variables x and invariant I(x) is refined by a concrete model CM with variables y and gluing invariant J(x, y). Event e is in abstract model AM and event f is in concrete model CM. Event f refines event e. $BA(e)(x, x0)$ and $BA(f)(y, y0)$ are predicates of events e and f respectively; we have to prove the following statement, corresponding to proof obligation (1):

$$I(x) \wedge J(x, y) \wedge BA(f)(y, y0) \Rightarrow \exists x0 . (BA(e)(x, x0) \wedge J(x0, y0))$$

We have shortly introduced the Event B modeling language and the structures proposed for organising the development of state-based models. In fact, the refinement-based development of Event B requires a very careful derivation process, integrating possible tough interactive proofs for discharging generated proof obligations, at each step of development.

III. NOC ARCHITECTURE OVERVIEW

A. NoC Architecture Topology

The topology of a NoC architecture is usually a Mesh. The network has a grid-like form (see Fig.2): boundary switches are connected to two or three neighbours, whereas other nodes are connected to four neighbours.

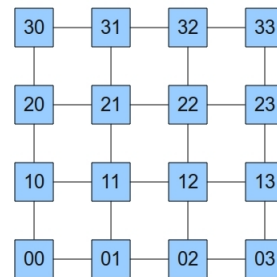

Fig. 2. A Mesh Topology

B. Structure of a Switch

The role of a switch is to pass data packets between elements (routers) of a NoC architecture.

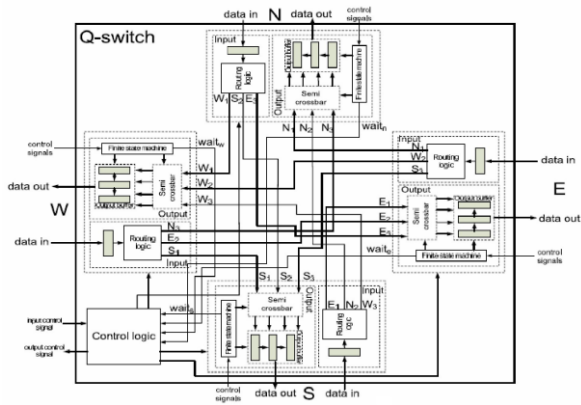

Fig. 3. Structure of a Switch

The structure of a switch (see Fig.3) is as follows:

- **Input Register:** Each incoming packet is stored in an input register. A specific component, called Routing logic, computes the next direction of the packet (whether N, E, S or W; see Fig.3). A maximum of three packets is allowed per direction. The packets are transmitted to the output logic. An arbitration policy can be adopted to define priorities between packets stored in the input registers of a switch, according to the next direction of the packets. This policy is based on the rules of right priority (see Fig.4).

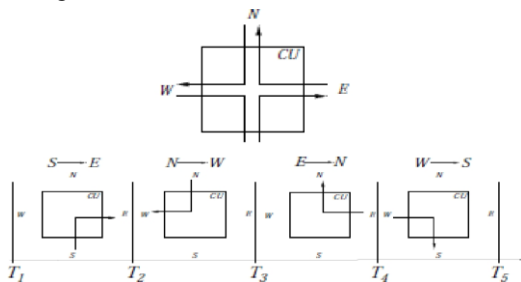

Fig. 4. Right Priority

- **The Output Logic** is made up of a semi crossbar, an out- put buffer and a finite state machine. The semi crossbar is composed of three inputs and four outputs. Incoming packets are stored into inputs according to priorities. If the neighbours of a switch are not busy, the first output of the semi crossbar is one of the adjacent switches. The output buffer consists of registers. These registers store packets, in the case where more than one packet choose the same output (direction). The output buffer is also used when the selected output (direction) is busy (occ signal). A maximum of three messages can be stored in a output buffer. The finite state machine (FSM) manages control signals and its role is also to avoid packets collisions.

Moreover, the finite state machine (FSM) provides a central logic with informations about the states of adjacent switches (wait situation, out signal, etc.).

- The Control Logic manages connections between the input and output ports of a switch. The Control Logic also handles the storage of packets that can not be transferred to next directions, due to occupation signals from neighbouring switches. Moreover, if the switch can not store more incoming packets, the Control Logic informs the neighbours (which have sent the switch packets) that the switch can not accept any other packets.

C. Routing Process

The XY routing algorithm defines packets transmission:

- Let the source (s) and destination (d) of a packet (p) be defined by 2D coordinates: (xs ,ys) for the source (s) and (xd ,yd) for the destination (d).
- The packet (p) travels first along x dimension, until $x_s = x_d$.
Then, the packet (p) travels along y dimension, until $y_s = y_d$.
- If the packet (p) encounters elements unable to transmit data in x dimension, the routing temporary switches to y dimension.
- It should be noted that the network can evolve (deletion of some links, isolation of some switches, etc.), and data transmission can be disrupted. However, a reconfiguration mechanism ensures that for each transiting packet, either

a path leading to the destination of the packet always exists or, if the packet is stored in some node unable to transmit data, the link between this node and the destination of the packet will eventually be restored.

IV. MODELING NOC ARCHITECTURE

This section presents the formal development of the NoC Architecture. However, due to space limitations, we have given sketch of the modeling. A detailed formal development is available1 . It should be noted that refinement allows us to break the complexity of the NoC Architecture and perform our formalisation with different levels of abstraction, step-by- step (see Fig.5).

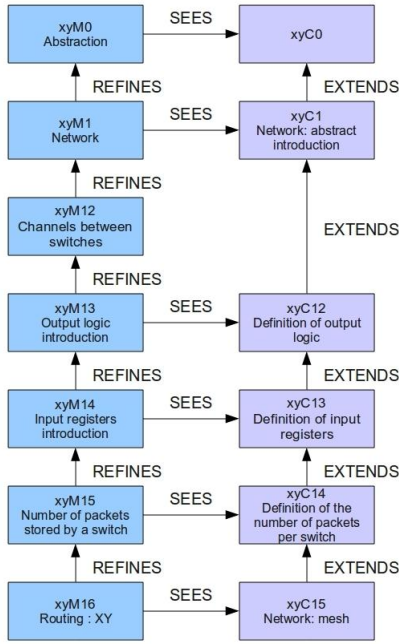

Fig. 5. Step-by-step Modeling of NoC Architecture

A. Abstract Specification: xyM0

The first model xyM0 is an abstract description of the service offered by the NoC Architecture: the sending of a packet (p) by a switch source and the receiving of (p) by a switch destination.



Fig. 6. Abstraction

A set of switches (N ODES), a set of packets (M SG), a function src, associating packets and their sources, a function dst, coupling packets and their destinations, are defined in context xyC0. The machine xyM0 uses (sees) the contents of context xyC0, and with these, describes an abstract view of the service provided by the NoC Architecture:

- An event SEND presents the sending of a packet (m), by its source (s), to a switch destination (d).

[1 http://www.loria.fr/~andriami/noc/pdf/project.html](http://www.loria.fr/~andriami/noc/pdf/project.html)

- An event RECEIVE depicts the receiving of a sent packet (m) by its destination (d).

Moreover, the model xyM0 allows us to express some properties and invariants:

$$\text{ran}(\text{received}) \subseteq \text{ran}(\text{sent})$$

This invariant expresses that each packet received by a switch destination has been sent by a switch

source.

B. First Refinement (xyM1): Network Introduction

The machine xyM1 refines xyM0 and introduces a network (a graph) between the sources and destinations of packets. Some properties on the graph are defined in context xyC1: graph is non-empty, non-transitive and is symmetrical.



Fig. 7. Adding Network

The events in xyM0 are refined:

- Event SEND: When a source sends a packet, the packet is put in the network.
- Event RECEIVE: A packet is received by its destination, if the packet has reached the

destination. New events are also

introduced by xyM0:

- Event FORWARD (see Fig.8): in the network, a packet (p) transits from a node (x) to another node (y), until the destination (d) of packet (p) is reached.

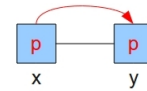

Fig. 8. Transfer of a Packet (p) between Switches

- Event DISABLE: A node is disabled. The node is not allowed to communicate with its neighbours (failure, etc.). During the disabling of some nodes, we ensure that the packets transiting in the network will eventually reach their destinations (either after a reconfiguration of the network or by always letting a path to destinations available).
- Event RELINK: This event models the reconfiguration of the network. Disabled nodes are re-enabled: the links between them and their neighbours are restored, therefore allowing communications and packets transfers. The reconfiguration of the network helps in demonstrating the safety of data transmission between a switch source and a switch destination.

The machine xyM1 also presents some properties of the system:

$$\text{ran}(\text{received}) \cap \text{ran}(\text{store}) = \emptyset$$

This invariant demonstrates that a packet (p) sent by a source is either traveling in the network (store) or is received by a destination.

C. Second Refinement (xyM12): Channels

Introduction

This second refinement decomposes the event FORWARD of xyM1 into two events:

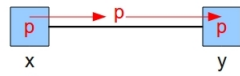

Fig. 9. Channel Introduction

- A refinement of the event FORWARD depicts the passing of a packet (p) from a switch (x) to a channel (ch), leading to a neighbour (y).
- An event FROM_CHANNEL_TO_NODE models the transfer of a packet (p) from a channel (ch) to a connected switch (n).

The machine xyM12 also defines some properties:

$$\text{ran}(c) \cap \text{ran}(\text{switch}) = \emptyset$$

The invariant expresses that each sent packet is either in a channel or in a switch. A sent packet can not be in a channel and in a switch at the same time.

D. Third Refinement (xyM13): Output logic Introduction

This refinement allows us to introduce the structure of a switch gradually. We express, in xyM13, that switches possess output ports (see Fig.10). The abstract event FORWARD is further decomposed:

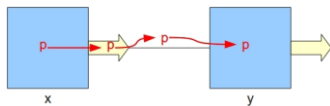

Fig. 10. Adding Output Ports

- The refinement of event FORWARD adds the fact that a packet (p), which is leaving a switch (x) and heading for a neighbour (y), first enters the output logic (op) of the switch (x) leading to (y).
- A new event OUTPUT_BUFFER_TO_CHANNEL models the transition of a packet (p) from an output port (op) to a channel (ch) leading to a target switch (n).

Moreover, new properties and invariants are defined in xyM13:

$$\begin{aligned} \text{inv1} &: \text{ran}(\text{chan}) \subseteq \text{ran}(\text{sent}) \\ \text{inv2} &: \text{ran}(\text{outputbuffer}) \subseteq \text{ran}(\text{sent}) \\ \text{inv3} &: \text{ran}(\text{outputbuffer}) \cap \text{ran}(\text{chan}) = \emptyset \end{aligned}$$

The invariant inv1 expresses that each packet transiting in a channel (ch) has been sent by a source (s); inv2 demonstrates that each packet transiting in an output port (ch) has been sent by a source (s); inv3 presents the fact that a packet is

either in an output port or in a channel, the packet can not be in an output port and a channel between two switches at the same time.

E. Fourth Refinement (xyM14): Input register Introduction

This refinement (xyM14) adds input ports to the structure of a switch.

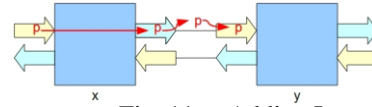

Fig. 11. Adding Input Ports

- The event SEND is refined: when a switch source (s) sends a packet (p), the packet (p) is put in an input port (ip) of the switch (s).
- The actions described by the abstract event FORWARD are decomposed:
 - The event SWITCH_CONTROL, a refinement of FORWARD, models the passing of a packet (p), from an input port (ip) of a switch (x), to an output port (op) leading to a switch (y).
 - The event OUTPUT_BUFFER_TO_CHANNEL presents the transition of a packet (p), from an output port (op), to a channel (ch) leading to a target switch (n).
 - The event FROM_CHANNEL_TO_INPUT_BUFFER demonstrates the transition of a packet (p) from a channel (ch) to an input port (ip) of a target switch (n).

The machine xyM14 also presents properties and invariants:

$$\begin{aligned} \text{inv1} &: \text{ran}(\text{inputbuffer}) \subseteq \text{ran}(\text{sent}) \\ \text{inv2} &: \text{ran}(\text{outputbuffer}) \cap \text{ran}(\text{inputbuffer}) = \emptyset \\ \text{inv3} &: \text{ran}(\text{inputbuffer}) \cap \text{ran}(\text{chan}) = \emptyset \end{aligned}$$

The invariant expresses that each packet transiting in an input port (ip) has been sent by a source (s); inv2 demonstrates that each packet is transiting either in an output port (op) or an in input port (ip); inv3 presents the fact that a packet is either in an input port or in a channel, the packet can not be in an input port and a channel between two switches at the same time.

F. Fifth Refinement (xyM15): Number of Messages per Switch

This refinement introduces the storage of packets in a switch: each output port of a switch can store a number of packets up to a limit (outputplaces) of three messages. Packets can be blocked in a switch, because of wait or occupation signals from neighbours.

The event SWITCH_CONTROL is refined, and adds the fact that following the transition of a packet from an input port of a switch (x) to an output port, if the switch (x) is not busy anymore, it sends a release signal to the previous switch linked to the input port. A new event RECEIVE_BUFFER_CREDIT models the receiving of a release signal by a switch (n).

G. Sixth Refinement (xyM16): Algorithm XY

The last model xyM16 describes the architecture of the network (graph): graph has a mesh topology (see Fig.12). A numerical limit (nsize) is introduced to bound the number of routers in the dimensions x and y of the network topology; the network will be a regular 2D-Mesh, with a size (nsize × nsize); each switch is coupled with unique coordinates (x, y), with

$$x \in [0..nsize - 1] \text{ and } y \in [0..nsize - 1].$$

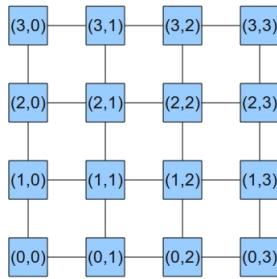

Fig. 12. A regular Mesh with 2D-coordinates

This coordinate system allows to be more precise on the neighbours of each switch, as seen in figure 12. This model also gives a fine-grained description of the structure of a switch (see Fig.13):

- A switch has generally four output ports and four input ports (usually labelled N, S, E and W), used for communication with neighbours.
- However, two more cases are distinguished:
 - Boundary switches in the corner have only two output ports and two input ports (N-E, N-W, S-E, S-W).
 - Other boundary switches have three output ports and three input ports (N-S-E, N-S-W).

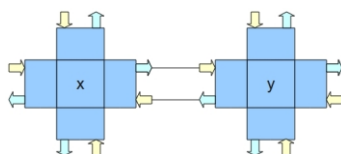

Fig. 13. Switches: Structure and Links

Moreover, this concrete model also introduces the XY routing algorithm:

```

D : destination. Coordinates (Dx, Dy)
C : current node. Coordinates (Cx, Cy)

if (Cx > Dx) :
    return W; (Case 1)
if (Cx < Dx) :
    return E; (Case 2)
if ((Cx = Dx) ∨ ((Cx > Dx) ∧ W is blocked) ∨
    ((Cx < Dx) ∧ E is blocked)) :
    if (Cy < Dy) :
        return N; (Case 3)
    if (Cy > Dy) :
        return S; (Case 4)
    
```

The cases of the XY routing algorithm are matched with refinements of event SWITCH_CONTROL:

- SWITCH_CONTROL_LEFT models Case 1: a packet (p) is transmitted, from an input port of a switch (x), to an output port, leading to a neighbour (y), located at W. This event is triggered if the x-coordinate of the destination (d) (of the packet(p)) is inferior to the x-coordinate of the current node (x).
- SWITCH_CONTROL_RIGHT models Case 2: a packet (p) is transmitted, from an input port of a switch (x), to an output port, leading to a neighbour (y), located at E. This event is triggered if the x-coordinate of the destination (d) (of the packet(p)) is superior to the x-coordinate of the current node (x).
- SWITCH_CONTROL_UP models Case 3: a packet (p) is transmitted, from an input port of a switch (x), to an output port, leading to a neighbour (y), located at N. This event is triggered if the y-coordinate of the destination (d) (of the packet(p)) is superior to the y-coordinate of the current node (x), and either, if the x-coordinate of the destination (d) is equal to the x-coordinate of the current node (x), or if the packet (p) can not transit along the x-axis.
- SWITCH_CONTROL_DOWN models Case 4: a packet (p) is transmitted, from an input port of a switch (x), to an output port, leading to a neighbour (y), located at S. This event is triggered if the y-coordinate of the destination (d) (of the packet(p)) is inferior to the y-coordinate of the current node (x), and either, if the x-coordinate of the destination (d) is equal to the x-coordinate of the current node (x), or if the packet (p) can not transit along the x-axis.

V. CONCLUSION

This paper presents an incremental development of a Network-on-Chip Architecture, using the Event B formalism. The formalization of the architecture is presented from an abstract level to a more concrete level in a hierarchical way. The complexity of the development is measured by the number of proof obligations which are automatically/manually discharged (see table I).

Model	Total	Auto		Interactive	
xyC0	3	3	100%	0	0%
xyC1	6	6	100%	0	0%
xyC12	0	0	100%	0	0%
xyC13	0	0	100%	0	0%
xyC14	1	1	100%	0	0%
xyC15	5	0	0%	5	100%
xyM0	26	25	96.15%	1	3.85%
xyM1	38	28	73.68%	10	26.32%
xyM12	72	45	62.5%	27	37.5%
xyM13	74	37	50%	37	50%
xyM14	67	23	34.33%	44	65.67%
xyM15	24	14	58.33%	10	41.67%
xyM16	26	18	69.23%	8	30.77%
Total	342	200	58.48%	142	41.52%

TABLE I SUMMARY OF PROOF OBLIGATIONS

We remark that for context xyC15 and machine xyM14, there are more interactive proofs than automatic ones. This is explained by the fact that a majority of these interactive proofs are quasi-automatic: the proofs did not need tough efforts (neither importing hypotheses or simplifying goals, etc.), the mere usage/running of provers (provided by the RODIN platform) allowed us to discharge these obligations. Contrary to the verification by simulation only, our work provides a framework for developing the Network-on-Chip Architecture and the XY routing algorithm using essential safety properties together with a formal proof that asserts its correctness.

As a part of our future efforts, we consider the translation of the most concrete (detailed and close to algorithmic form) model into an intermediate language, from which hardware description (e.g. in VHDL) can be extracted. Moreover, we note that the first levels of the Event B design of the NoC Architecture express general cases of routing methodologies and fall in the interesting domain of reusable and generic refinement-based structures [3, 9]. We plan to investigate further on this domain of genericity and reusability of proof-based models.

ACKNOWLEDGMENT

This work has been financed by the joint project STIC- Algérie 2011-2013 between the Université de Tiaret and the research group MOSEL/VERIDIS on the formal development of

FPGA circuits.

REFERENCES

- [1] J.-R. Abrial. Modeling in Event-B: System and Software Engineering. 2010.
- [2] J.-R. Abrial, D. Cansell, and D. Méry. A mechanically proved and incremental development of ieee 1394 tree identify protocol. *Formal Asp. Comput.*, 14(3):215–227, 2003.
- [3] M. B. Andriamiarina, D. Méry, and N. K. Singh. Revisiting Snapshot Algorithms by Refinement-based Techniques. In *PDCAT*. IEEE Computer Society, 2012.
- [4] R.-J. Back and K. Sere. Stepwise refinement of action systems. *Structured Programming*, 12(1):17–30, 1991.
- [5] D. Cansell, C. Tanougast, and Y. Beviller. integration of the proof process in the design of microelectronic architecture for bitrate measurement instrumentation of transport stream program mpeg-2 dvb-t. 2004.
- [6] S. Jovanovic, C. Tanougast, and S. Weber. A new high-performance scalable dynamic interconnection for fpga-based reconfigurable systems. pages 61–66, 2008.
- [7] C. Killian, C. Tanougast, F. Monterio, and A. Dandache. Online routing fault detection for reconfigurable noc. In *International Conference on Field Programmable Logic and Applications*, 2010.
- [8] G. T. Leavens, J.-R. Abrial, D. S. Batory, M. J. Butler, A. Coglio, K. Fisler, E. C. R. Hehner, C. B. Jones, D. Miller, S. L. P. Jones, M. Sitaraman, D. R. Smith, and A. Stump. Roadmap for enhanced languages and methods to aid verification. In S. Jarzabek, D. C. Schmidt, and T. L. Veldhuizen, editors, *GPCE*, pages 221–236. ACM, 2006.
- [9] D. Méry. Refinement-based guidelines for algorithmic systems. *Int. J. Software and Informatics*, 3(2-3):197–239, 2009.
- [10] Project RODIN. Rigorous open development environment for complex systems. <http://www.eventb.org/>, 2004-2010.

Based B Extraction of QNoC architecture properties

Abdelhamid Hariche*, Mostefa Belarbi*, Hayat Daoud +
Ibn Khaldoun University, Computing sciences department
LIM , Tiaret, Algeria

*haricheabdelhamid@gmail.com **mbelarbi@mail.univ-tiaret.dz +hayat.daoud@hotmail.fr

Abstract—Embedded systems become more and more present in our daily life. The validation of this kind of systems with time their evolution became fast and complex we focus on multiprocessor systems on chip (MPSoC) and exactly Quality of Service of Network on chip architecture (QNoC). The interconnection of communication modules (IP - Intellectual Property) constitutes a fundamental part during the design of such systems expressed in terms on band-width, latency, power consumption and reliability. The validation currently for MPSoC (with QNoC's basis) based on the logical simulation which it can't allow a global validation for this system even it is not adapted for the design of high level integration complex systems (Handicaps with respect to the concept *time to market*).

The new validation approach using the formal technics using B event method consists of suggesting aspects and constraints related to the reliability of NoC and the over-cost related to the solutions of tolerances on the faults (a design of NoC tolerating on the faults for SoC containing configurable technology FPGA) by extracting the properties of the QNoC architecture existed in the VHDL code associated and prove these last using the prover that used in B event method. This approach makes it possible to exploit.

Keyword- MPSoC, Formal Technics, Generating Model, QNOC, VHDL, B Event, incrementale

I. INTRODUCTION

Systems integrated on chips (or Systems On Chips) are more and more complex and integrate an increasing number of processing units to answer needs of new applications. This growth entails an increase of communication needs in circuits for exchanges of data and for the processing control. The evolution of the silicon technologies makes possible this density of integration. With scales sub-Micronics news constraints appear however. The interconnections cost becomes greater to the one used in the logic. Communications become major goal for performances of systems.

Having made this report, different groups of research have been brought to propose a new paradigm: the network on chip (NoC). Because of the complexity of several applications and the integration, inventors get on more and more resource of calculation (i. e. IPs) in a system on chip. However, it returns the manufacture test of these

systems more difficult, notably systems on chip based on networks on chip QNoC. To perform the routing communication, we must use several routing algorithms [01], but this can make some main problems:

the failure routing decision errors and the dropped node on the way problem which yielded the failing of the material.[02][03]

Using the embedded systems concept, we can process microelectronic aspects of integrated circuits on the SOC, we propose in this document to develop a methodology that used the B method for the verification of the system on chip field. The objective is to propose a formal model [04]with the help of the language B-event to verify the network on chip architecture (QNoC), and the safety working of this last, and That is innovating these systems on chips.

There are research works which allow to test of NoC [05] using declarative assertions to specify expected functional and temporal properties of modules and/or their environment by the recognizing what's valuable such as the constraint for the correctly-use of a node (or IP) and it delivered result even the correct behavior from the design. PSL is a formalism ease writing temporal and logical properties, the online embedded testing using technique for synthesis from the assertion and properties for a monitor, this work use the notion of monitor to pinpoint erroneous transactions between modules that belong to different clock domains concept suggested which is coded using VHDL or Verilog as language.

In some researches[06] they think for avoiding the risk of functionality they need a specification analysis and modeling techniques in software community just like SLOOP or System Level design with Object Oriented Process .SLOOP employs four UML (Unified Modeling Language) models which detailing those three aspects the target system functionality , structure and timing . Each model is used to develop a system before software and hardware implementation. Conceptual Model is the result of the analysis of requirements to avoid non-functional constraint for a customer. Functional model for the representation of structure of function and the task of level of parallelism carrying of computing workload and communication workload. Architectural model represent the physical resources

of architecture it consist the processing resources and communication resources also it parameterize each resource using the concept of class. Performances model which maps process of functional model onto processing resources of architectural model, this model valuates the performances of the selected architecture using statistics, it helps the designer to improve the system which satisfies the requirements of the design.

Some solutions [07] that used formal technology which extract properties from the existed coded need five steps, the first step is to run automatic formal to explore the reachability of the design, the next step is to run simulation to capture code coverage results, the third step in the flow is to run automatic formal on the design with the merged simulation-coverage database to make the modification of the design more easily verifiable, the final step in the flow is to prune out the coverage goals proven unreachable in Step 3 from the simulation database and generate accurate code coverage metrics that reflect what is truly reachable in the coverage model of the design.

There are a several solutions to verify any NoC design but all the method had to make in the final way an implemented code with the VHDL language and here the point which our work will start to translate the VHDL code to B event model to ease the formal checking for this design [08].

I. Based B method

B is a method for specifying, designing and coding software systems. It is based on Zermelo-Fraenkel set theory with the axiom of choice, the concept of generalized substitution and on structuring mechanisms (machine, refinement, implementation). The concept of refinement is the key notion for developing B models of (software) systems in an incremental way. B models are accompanied by mathematical proofs that justify them. Proofs of B models convince the user (designer or specifier) that the (software) system is effectively correct. We provide a survey of the underlying logic of the B method and the semantic concepts related to the B method; we detail the B development process partially supported by the mechanical engine of the prover.

1. B event method

B event is the extension of B method [09] for the design of different systems with the replacing of concepts for machines and operations by the models and events. These models can be seeing as a package for modeling the environment of any modeling systems which is evaluating its state using events. These last are specify by the use of guarded actions which activated when their guard were true . In this case each event had a function to act this notion is inspired from the guarded command of Dijkstra[10] or the action for Back[11].

Every event for B event is representing by a state predicate called guard, a substitution for the goal of modify the values of variables of the system. For a given state many system guards can be true, one of them can be triggered when its substitution can be carry out. B event models are composing of two based constructors Contexts and machines, the first represent the static part of model when the second is for the dynamic one.

2. Context structure

The Context contain many clauses introduced by a specific keywords as they are shown within Rodin platform, some clauses are introducing with modeling elements with labels (theorem axioms) which is generated automatically in the Rodin platform, such as “Sets” which defines the carrier set of the Context, “Constants” is the list of various constants introduced in the context, “Axioms” lists of the various predicates which will be present as hypotheses in all the proof obligations, “Theorems” lists of theorem which have to be proved within the context, “Extend” defines if a context is the extension of another (if exist) [11].

3. Machine structure

As the same of context, the machine had a specific keywords with labels introducing and automatically generated in the Rodin platform; “Refines” contains (if any) the machine which this machine refines; “Sees” list of contexts referenced by the machine, “Variables” lists the various variables introduced in a machine, “Invariants” the list of predicates which the variables must obey, “Events” lists various event in a machine(and they had a predefined syntax on the Rodin platform)[12].

4. Proof obligation

The proof obligations define what is to be proved for an Event-B model. They are automatically generated by rodin platform tool called the proof obligation generator, just to check contexts and machines texts and decide what is to prove in these texts, there are eleven rules for the proof obligation all defined and labeled inside the Rodin platform [12].

III. Case Study

1. Architecture presentation

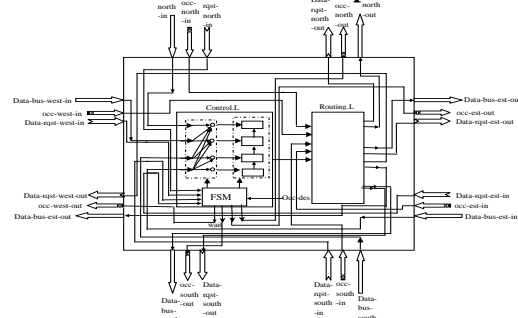

Fig.1. Architecture of Q-Cu-Switch[12]

In this report we focused on the Q-Cu-Switch formalization which is a combination between two existed switches(Fig.1). This next table demonstrates the difference between a Q-Switch and a Cu-Switch:

Q-Switch [13]	Cu-Switch [13]	Q-Cu-Switch [13]
Unidirectional bus	Bidirectional bus	Bidirectional bus
One buffer for each input	one buffer for 4 inputs	A single buffer for 4 inputs.
The priority on right for the arbitration Policy.	Arbitration Policy is based on the priority on right.	Arbitration Policy is based on the priority on right.

Remark: It may that several flits take the same way-out direction. In this case the switch takes 3 flits at maximum.

A policy of arbitration must be adopted for the logic routing which manages the priority of sending of the flits. This policy is based on the rule of “the priority on right”. It is built individually for each port of Q-Switch (Fig.1).

2. Routing algorithm

The flit is initially conveyed in direction X and in addition following the direction Y (Fig.2) until the final destination This classic routing algorithm is not adapted to the networks dynamic evolution. Using this module based on the policy of routing of Q-Switch with its algorithm of

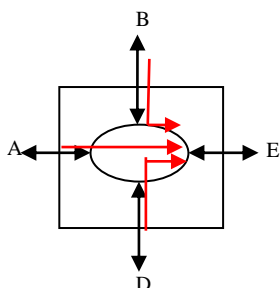

Fig.2. Example for XY routing algorithm [01]

adaptive routing modified XY. The flits are conveyed as the same case in the classic XY routing algorithm. If during routing of X, a flit meets a processing element, it will modify the routing temporarily of X with Y. With this intention, Q-Switch uses its coordinates and the signals control of the input which indicate the nature of its neighbors (Q-Switch or IP). The flits cannot take the arrival directions this restriction simplifies a little bit on the logic routing to each port.

This routing algorithm which makes the flits always takes the shortest way between two IPs, i.e. All the sending flits of one IP to the other will cross the same number of Q-switches. This fact avoids the regrouping situations of the flits to its destination node. In order to avoids situations of deadlock for some Forbidden cases.

IV Model Generation

The new validation approach using the formal technics based on the generation of model of a high level design of the MPSoC for the architecture NoC. The formal translation which is the step of getting a formal model in event B from the code VHDL representing the Q-Cu-Switch architecture.

In the next section we try to exploit some important points we had remark during the phases used on the auto-translate model.

1. Formal translation model

Two method are involved in this phase the translation of the code blocks (total blocks approach) to a model in event-B or just the checked blocks (checked blocks approach) using the proof obligation.

The main concept of making formal translation in the first case to the event-B model is the composition of the event B model itself that it made of several components: machines containing the dynamic parts for a model and contexts containing the static parts for a model [11]. So the extraction from a VHDL code of the dynamics parts and the statics ones required the declarations in the code and the behavior of the code used i.e. the extraction of relations between different instructions blocks.

The declarations on ENTITY even on ARCHITECTURE can represent the constant or variable or set for each event B model, so the axioms, theorems, invariant and different predicates are the result of the translation of instruction blocks.

This the event B model [04] obtaining for Q-Cu-switch which has toke as an illustrated example to show the first approach for the formal auto-translate model step knowing that this last have been improved and it assured the well function for some characteristic of the Q-Cu-switch architecture programmed on VHDL[08].

It is the first model (Fig.3) which generally contains predicates when just the human may be able to model but in this case (Q-Cu-switch architecture) the possibility of the translation was clearly present and thus can be a positive point for this kind of translation approach

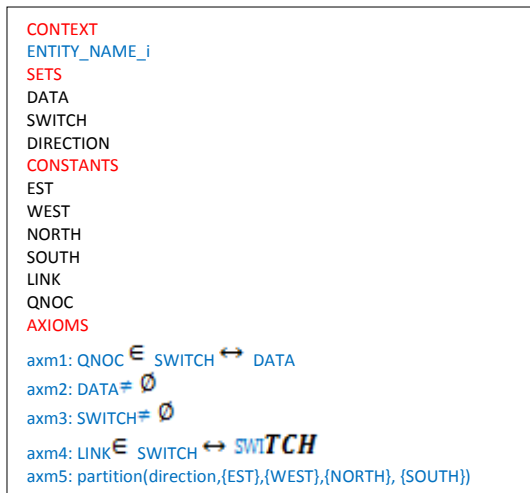

Fig.3.a First Event B model for QNOC system [04]

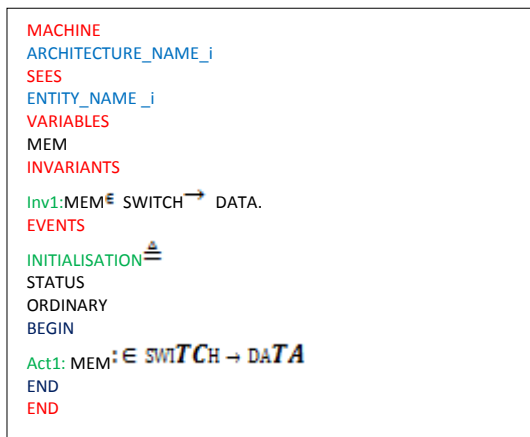

Fig.3.b First Event B model for QNOC system [04]

2. Complete blocks step
a) Context generation

The figure (Fig.4) summarizes the reason to consider the existence of DATA as set and this is the manner used:

-In the part Generic a great value with the type integer has allocated for a variable called N, which lead to check it in all the declarations which had used this variable.

Generic integer N:=20; -- this instruction
Constant integer N:=20; -- or even this instruction

- From all the checked declarations there are 4 Input ports and 4 Data output ports and that means the existence of a set called DATA :

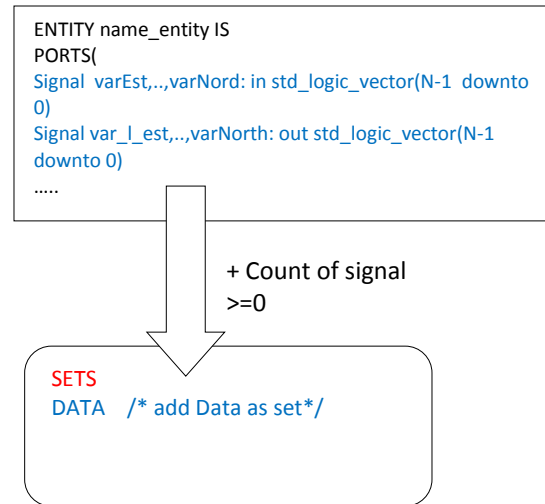

Fig.4. Example of translating to a set

VHDL syntax:

Signal var1,var2,var3,var4: In std_logic_vector (N-1 downto 0)

Signal var_out1,var_out_2,var_out_3,var_out_4: Out std_logic_vector(N-1 downto 0)

And all the other sets had been extracted by the similar method at almost.

For the case of constants we take LINK which had extracted because of the variables which represent ports in the reason that they had Std_logic as type (Input and output) thus oblige the communication using at least a link between switch, when it assumed that the set SWITCH had extracted with the other sets using the explained method previously (Fig.5).

VHDL syntax:

Var_io_1,.....,var_io_n : in Std logic ;

Var_io_1,.....,var_io_n : ou t Std logic ;

Therefore it is similar to translate from the VHDL code all the constants with the particularity of:

- The enumerated type may toke as Constants.
- Some relation or function (picked from instructions) which must already exist as a constants e.g. QNOC.

As what we explain about axioms previously, from the falling edge for each process, the variable used is for a SWITCH (or its component) or DATA in bidirectional sense (in switch register, data out of the switch). And the picking up is doing for any element from of each set.

VHDL Syntax

- Case for the relation SWITCH → DATA :

data out=different_Values; -- different_vaules can take register

- Case for the relation DATA → SWITCH :

Register=different_values; -- different_values can take data in

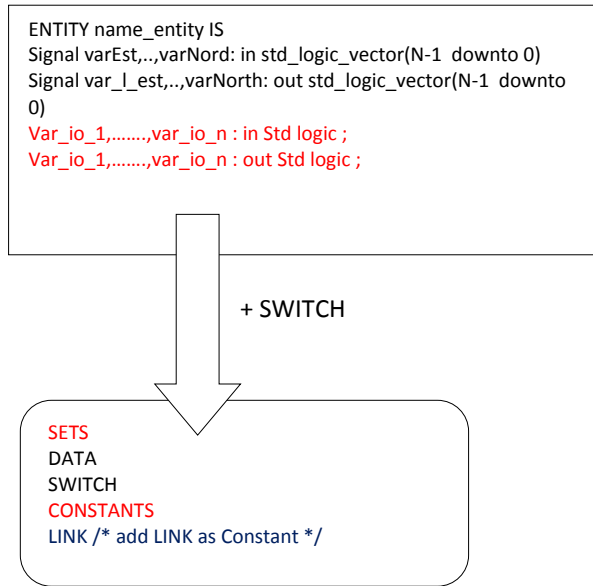

Fig.5. Example of translating to a constant

Extracting from the falling edge implies to specify all the system when it assumes that the constant QNOC was extracting i.e. at result:

axm1: QNOC ∈ SWITCH ↔ DATA

It is similar to translate from the VHDL code all the Axioms which are:

- A typing for a constant or sets.
- Set definition for constant or sets as predicate for either the relation type or the set construction.

Remark: Founding out that the events in the machine contain guards and substitutions which are predicates thus lead to use the same method for the axioms translation.

This next figure (Fig.6) illustrates the manner to extract the predicate *axm1*.

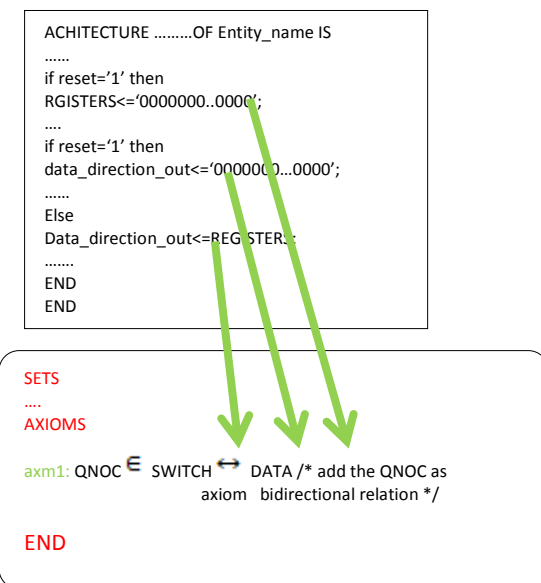

Taking example(Fig.7) the event *evt* there is a test used for the *nb_paquets* for a safety routing with conditions:

VHDL syntax

- Condition(or guard) 1:

Data_to_route <=data_direction_in; -- and this is the action

Registers <=anothers_differentes_data_direction_in; And this condition for the no-duplicate copies for a same data thus is translating as:

MEM(SWITCH_RECEIVER) ≠ DATA1

- Condition(or guard)2:

Router_occ_out=0000|1111;

⋮

Occ_west_out<=router_occ_out(i);-- when 0≤i≤3

And that means thesending information to a Nabors about the state of the SWITCH_ROUTER:

SWITCH_ROUTER ↔ SWITCH_RECEIVER ∈ LINK

These conditions summarize how to routing a data and that present in the action:

MEM(SWITCH_RECEIVER) = DATA1

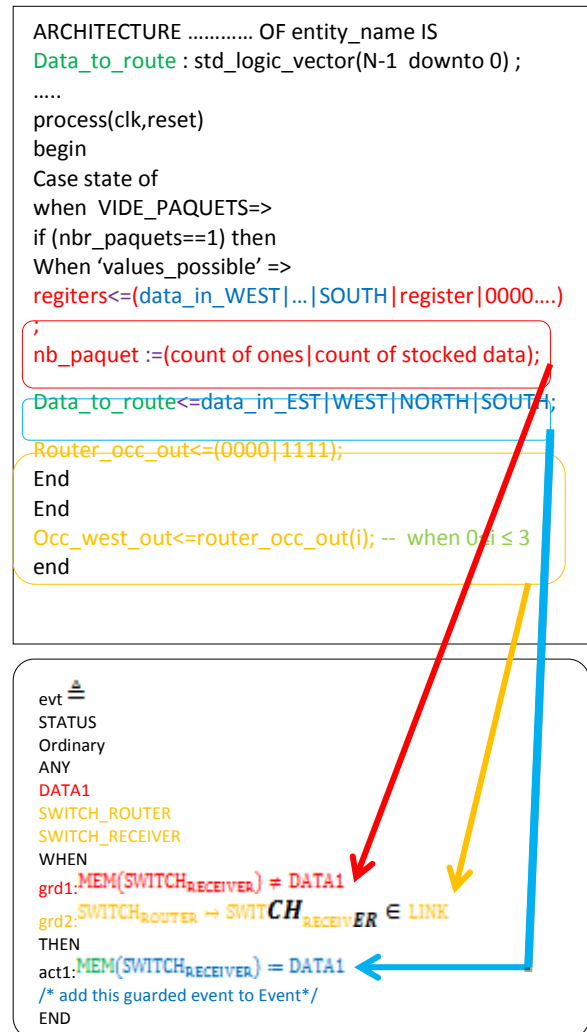

Fig.7. Example of translating to a guarded event

And all the events have the same manner to being extracted taking as consideration:

- The type of each event.
- The use of sets in each event.

c) Approach disadvantages

This approach has as negative points:

- Un-use interpreting for some components which can be added intuitively.
- The conflict on the order during the translation either sequentially or concurrently or following the system characteristics.
- The dissimilarity in the translation using the behavior makes the complexity for this process increase.

These reasons imply to use the second approach which is our Future work.

3. Checked blocks step

For the auto-translate model which uses the checked blocks the manner of translation is the same in the particularity of:

- The focalization on the events and the set of predicates proved in each model.
- The verification of the existence for the declarative parts for each model in the VHDL code.
- The addition for the missing declarative parts checked.

V. Conclusion

This research work is the combination of several translators event B, other languages but in the particularity of the use of the semantic basis and it takes as advantages:

- The possibility of translation of VHDL code onto proved event B model which will assure the function of the QNOC system.
- The automation of the translation decreases the modeling time rate.

However this work will be developed to be adopted for any QNOC architecture even in the future several systems and also to obtain the well-structured VHDL code assured by the well-proved Event B model to decrease the *time to market*.

REFERENCES

[01] S. Jovanovic, C. Tanougast, C. Bobda and S. Weber: *A New Deadlock-free Fault-tolerant Routing Algorithm for NoC interconnections*, The 19th Int. Conference on Field Programmable Logic and Applications, IEEE Circuits and Systems Society, Pp. 326-331. 2009.

[02] N. Karimi, A. Alaghi, Z. Navabi, *online network-on-chip switch fault detection and diagnosis using functional switch faults*. Journal of universal computer Science, vol.14, no. 22, pp. 3716-3736. 2008.

[03] S. Y. Lin, W. C. Shon, C. C. Hsu and A. Y. Wu, *Fault-Tolerant router with built-in self-Test/-diagnosis and fault-isolation circuits for 2D-mesh based Chip multiprocessor systems*, Int. Journal of Electrical Engineering. Vol. 16, No 3, pp. 213-222, 2009.

[04] T. B. Meziane. *For modeling a NOC switch using B event*, theme for Master Degree Computing ingenery University of Tiaret. 2011.

[05] K. Morin-Allory L. Fesquet D. Borroine *Asynchronous Assertion Monitors For Multi-clock domain system verification* 2006.

[06] Q. Zhu, A. Matsuda, S. Kuwamura, T. Nakata *An Object-Oriented Design Process for System-on-Chip using UML* IEEE article, 2002.

[07] R. Sabbagh H. Foster *Using Formal Technology to Improve Coverage Results* April 23th 2012.

[08] A. Hariche, *Design and of a verification environment for the implementation of embedded applications*, theme for Master Degree Computing ingenery University of Tiaret. 2012.

[09] J.-R. Abrial. *Extending B without changing it*, for developing distributed systems, Proceedings of the 1st Conference on the B method, pp. 169–191. November 1996.

[10] E. Dijkstra. *Guarded commands, nondeterminacy and formal derivation of programs*. *Communications of the ACM* CACM 18. 1975.

[11] J.-R. Abrial. *Modeling in Event-B*, system an software engineering. Book published by university of Cambridge pp 176-203. 2010.

[12] R. J. Back *Stepwise refinement of action systems*, CREST 1991.

[13] H. Daoud *Modeling and validating for architecture of network on chip NOC*, theme for Master Degree Computing ingenery University of Tiaret. 2011.

Formal Specification by Coq of Date and Darwen's Object/relational Model

Amel Benabbou

LITIO Laboratory – University of Oran
BP 1524, El-M'Naouer, 31000
Oran, Algeria
benabbou amel@yahoo.fr

Safia Nait Bahloul

LITIO Laboratory – University of Oran
BP 1524, El-M'Naouer, 31000
Oran, Algeria
nait-bahloul.safia@univ-oran.dz

Abstract— Development of databases software systems would be provided with a high-level specification, suitable for formal reasoning about application-level security and correctness properties. Formal specification is a key element of formal methods. It can greatly increase comprehension of a system by revealing inconsistencies, ambiguities, and incompleteness that might occur. Thus, implementation would be proven correct with respect to this specification to ensure that a bug cannot lead to non-conformance of properties or accidental corruption. It is for these reasons that we see verified DBMSs as a compelling challenge to the development of software. As a step toward this goal, we establish in this paper formalization through a formal specification of some basis concepts in object/relational model proposed by Date and Darwen, using the Coq proof assistant system. We give the challenges acquired from our experience using that proof tool. Our work is a preamble step toward a fully-verified object/relational DBMS.

Index Terms—Formal specification, proof assistant system, Coq, verification, object/relational model.

introduction

Software databases systems inevitably grow in scale and functionality. Because of this increase in complexity, the likelihood of subtle errors is much greater [1]. A major goal of software engineering is to enable developers to construct systems that operate reliably despite this complexity. One way of achieving this goal is by modeling them in a formal way [2, 3]. Formal modeling plays a key role in building of high assurance and trusted software databases systems. This modeling enables formal reasoning about the system design that can be used to prove that the system has certain properties [4, 5]. A distinguishing feature of high assurance systems is that they are modeled mathematically using formal methods [6, 7].

Formal methods consist of a set of techniques and tools based on mathematical modeling and formal logic that are used for *specification*, development, proof and verification requirements and designs in software systems, such as in databases management systems (DBMSs). Particularly, they provide a mathematical framework in which it is possible to ensure the correctness of development and assurance in the validity of the

results [8]. By defining languages with a clear semantics, and making explicit how to reason on these later.

Specification is a key element of deductive formal methods; it's the process of describing a system and its desired properties [9]. Formal specification uses a language with mathematically defined syntax and semantics.

One current trend is to integrate different specification languages, each able to handle a different aspect of a system. Another is to handle non-behavioral aspects of a system such as its performance, security policies, architectural design, and theoretical concepts, integrity constraints, functional dependencies in Databases [10, 11, 12]. Formal specification can greatly increase our understanding of a system by revealing inconsistencies, ambiguities, and incompleteness that might otherwise go undetected. Therefore, it seems very interesting to use specialized software to assist in the specification by means of *Proof Assistant system* [13, 14, 15]

The goal of this paper is to give a formalization of some key concepts of the orthogonal object/relational model of Date and Darwen proposed in [16], the different concepts are expressed in terms of the type system which we have presented in [17]. This type system has a pseudo-algorithmic and grammatical description of all types in such model, namely: scalar, tuple, and relation types. Our algebraic grammar describes in detail the complete specification of an inheritance model: simple and multiple. An extension of this type system is performed by a special type representing null values [18]. Such an extension is prompted by a position that favors the existence of null values in object / relational model and proposes a semantic expression. We describe, specially, a formal specification for these concepts using Coq Proof Assistant [19].

Coq Proof Assistant is designed to develop mathematical proofs, and especially to write formal specifications, implementations and to verify using type-checking algorithm that the later are correct with respect to their specification. Thus, it allows interactively constructing formal proofs and supports specification of static data, functions and definitions which can be developed using the basic specification

language Gallina in Coq. Using Curry-Howard isomorphism [20, 21], programs, properties and proofs are formalized in the same language called Calculus of Inductive Constructions [22], that is a λ -calculus with a rich type system [23, 24]. Conveniently, the reasoning is at the same platform with the specification. All above strong points of Coq make us to use it to finish our specification work.

This article is organized as follows. Section 2 is a definition of theoretical concepts of Date and Darwen's data model. In section 3 we present our formal specification for most important relational concepts in that model using the proof system Coq. In section 4 we discuss the challenges we faced using that proof environment of development in building such specification. Finally, a conclusion closes the paper.

Definition of basic concepts in date and darwen's data model

Date and Darwen have proposed a theoretical basis for integration of a few object concepts in the relational context [16]. In that model, it's not necessary to restructure the model to achieve the object concepts. It is enough to expand domains to new abstract data types, and allow inheritance and sub-typing in order to take advantage of the object-orientation features.

Date and Darwen have also proposed a query language *Tutorial D* and relational algebra *A*. The semantic links between these entities are modeled through the concept of relation variables (*relvar*). The DBMS *Rel* implements a significant portion of [Date](#) and [Darwen's Tutorial D query language](#).

Thus, Date and Darwen have given formal definitions adapted to their vision of future databases. We present such definitions as follows:

Definition 1 (Heading). A *Heading* {H} is a set of ordered pairs $\langle A, T \rangle$ such as:

- a. A is the name of attribute in {H}.
- b. T is the declared type of the attribute A.
- c. Two pairs $\langle A_1, T_1 \rangle$ and $\langle A_2, T_2 \rangle$ are considered if $A_1 \neq A_2$

Definition 2 (Tuple). Given a collection of types T_i ($i = 1, 2, \dots, n$, where $n \geq 0$), not necessarily all distinct, a *tuple* t -over those types- is a set of n ordered triplets of the form $\langle A_i, T_i, v_i \rangle$, such as v_i is the value of the attribute A_i of type T_i .

Definition 3 (Body of relation). A *body* B_r of a relation r is a set of tuple t_i . However, there may be exist tuples t_j that conform to the heading {H} without that $t_j \in B_r$.

Definition 4 (Relation). A *relation* r is defined by its heading {H_r} and its body B_r . The Heading {H} represents the schema of the relation r .

Given a heading {H}, a relation variable *relvar* must be of type RELATION {H} [16]. The instantiation of a relation variable *relvar* is done explicitly during the operation of defining *relvar*, or an empty relation if no explicit value is specified.

Formal specification of basic concepts by Coq assistant proof

In this section, we describe a formal specification by choosing an appropriate encoding of the object/relational model and using an adequate efficient environment for formal reasoning and specification, namely Coq assistant proof system.

Formalization of basic concepts is given for many reasons:

- Basic concepts and algebra make foundation constructs of the model, indeed; their specification establishes formal semantics that conspire to take a formal and rigorous comprehension of these concepts.
- Specification of a concept is strongly linked to another concept such as with relation and tuple.
- Specification of queries is based on the specification of the basic concepts (a query concerns necessarily a relation).
- Passing to verification tasks is necessarily preceded by a detailed specification of every concept.

Relational algebra has a standard definition in terms of set theory [25]; therefore, we consider that our work of specification deals with realizing both sets and relational algebra (see section D) in coq. We describe briefly in an informal way the key relational concepts in that model and how specifying them within Coq.

Object/relational model of Date and Darwen is modeled using relations. In such model, a relation is represented by some *heading* and a *body* which is simply a finite set of tuples over a *set* of couples (attribute, type). To simplify our work and accordance the typing environment of Coq, we consider that an attribute in a heading is represented by its type. So, the heading is described as a *list* of types. The list of types that describes the attribute is then known as the *schema* for the relation. *Tuples* in a relation are indexed by a set of attribute names. Again, for reason of simplification, we use the position of an element as the attribute name.

There are many ways to represent relations in Coq [19]. For example, in [26] it is suggested that schemas should be represented as functions from a finite set of attribute names to type names, but in practice, we found that a concrete encoding using a list of type names yields a more workable representation. Another choice was how to represent relations as finite sets. Finite sets are a common

abstraction and Coq conveniently provides them as a standard library.

We provide now formal specifications of these concepts using Coq assistant proof system:

A. Schema of relation (the heading)

We define the schema for a relation as a list of type names which denoted `tnameHeading`. Each type in the heading are is generated recursively from a type system defined in [17] and we might define `tnameHeading` as the inductive definition:

```

Inductive tnameHeading : Set :=
| Integer : tnameHeading
| Boolean : tnameHeading
| Char : tnameHeading
| TUPLE:tnameHeading
| RELATION: tnameHeading
...
| Option: tnameHeading -> tnameHeading.
    
```

We must indicate here that “Set” refers to Coq’s predefined *sort* or *type universe* [19], not sets in the sense of relations (in Gallina language, the term `tnameHeading` is called *specification*). Type `TUPLE` and `RELATION` will be given in next sections. *Option* constructor is used to denote a particular type that contains no values (null values “ \perp ”) which we have presented in [17] and treated within the type system given in [18] through our in-depth study of Date and Darwen’s object/ relational model [16].

Type names can be mapped to Coq types by a denotation function `tnameDenote`. The definition for type names below and the denotation function are parameters to the system so that users can easily add new constructors to the set of schema types. We define this denotation function as:

```

Fixpoint tnameDenote (t:tnameHeading) : Set :=
match t with
| Integer => Z
| Boolean => bool
| Char => string
...
| Option t' => option (tnameDenote t')
end.
    
```

The function `tnameDenote` is defined as recursive (via `Fixpoint` coq’s key word). In this definition, `tnameDenote` take `t` as argument of type `tnameHeading` on which recursion is organized, and return some type represented as universe “*Set*” since `tnameDenote` a general function for defining types. defined `tnameDenote` recursive functions contain a *filter* (with coq’s *match* key word) on the argument `t`, so that it is led to give in fist the value of the function when the argument is `nat`, `boolean`, and so on, then the value of the function when the argument

is of the form “*option t*” with the possibility of using the value of the same function in `t`.

In Coq, generally, option types are used instead of *not.found exceptions*. Our idea of choosing use of option types is due to try extending the `tnameHeading` of the partial function `Option t: tnameHeading → tnameHeading`, by the special value \perp such that `Option t' : tnameHeading → tnameHeading ∪ { \perp }` is a total function. `Option t'` return the current type name for an attribute or *None* if no such type exist. `Z`, `bool`, etc are the corresponding Coq types. The values that make up tuples are inhabitants of the denoted Coq types.

Thus, we give the overall formal specification of a schema of relation (represented as a list of type names) as follows:

```

Parameter tnameHeading : Set.
Parameter tnameDenote : tnameHeading -> Set.

Definition Schema : Set := list tnameHeading.
    
```

Date and Darwen’s 8th RM¹ prescription entitled *EQUALITY* has affirmed that Tutorial D shall support the equality comparison operator for every type `T`. We need then to be able to compare schemas for equality. Equality between arbitrary Coq types is undecidable, so we require decidable equality on type names as another parameter to the system, and is expressed with the following specification:

```

Parameter tnameHeading_dec_eq :
forall (x y: tname), {x=y} + {x<>y}.
    
```

Additionally, formalizing in dependent type theory often requires representing sets as setoids, i.e. types with an explicit equality relation. Thus, we require that for any type name, the Coq type `T` that it denotes satisfies the following properties (which we need in our future work for queries optimization verification):

1. `T` must be a decidable setoid i.e., equipped with a decidable equivalence relation.
2. `T` must be a decidable total order i.e., equipped with a decidable total ordering compatible with the setoid.

Like decidable equality for type names, these properties on denotations are given as parameters to the system: Property (1) allows for equivalence relations on attributes types that are weaker than syntactic Leibniz equality. Property (2) is required because of the way we build sets of tuples,

¹ RM: Relational Model

B. Tuples (the body)

Each attribute in a relation is of some type, a tuple associates a value of the appropriate type to each attribute. That is, a tuple is a heterogeneously-typed list. The type of a tuple is given by a recursive, type-level function `Tuple` parameterized by some Schema `S` (defined above). In Coq, we specify a tuple as a list of pairs (value, type) represented here as `(v,t)`, constructed by Cartesian product of latter pairs and terminated by Coq's `unit` type in order to mark up the end by `nil`. `Unit` is the Coq's singleton data type that contains a sole inhabitant written `tt`, and predefined as:

```
Inductive unit : Set :=
  tt : unit.
```

The Coq system provides a notation for lists, so that "cons v t" is noted "v :: t" (where:: is list cons). Formal specification of tuple type is given as follows:

```
Fixpoint Tuple (S: Schema) : Set :=
  match S with
  | nil => unit
  | v :: t => tnameDenote v * Tuple t
  end.
```

Tuples of the body of some relation are essentially iterated pairs of values terminated by a unit. For example:

```
Definition MySchema : Schema :=
  Z :: char :: Bool :: nil.
```

A tuple on such schema may be:

```
Definition aTuple : Tuple MySchema :=
  (100, ("Omar", (true, tt))).
```

We need several tuple manipulation functions in order to express the relational operations. For example, to perform product of tuples, we define the function `FProdTuples` that realize the operation of fuse tuples. The type of this function ensures that the schema of the resulting fused tuple is the concatenation of the input schemas:

We also use the richness of Coq's type system to help simplify reasoning about error cases. For instance, to project out the type name of a particular attribute `A` (represented by the position `n`) from a schema `I`, we need to provide a proof `pf` that `n` is less than the length of `I`:

```
attType (I:Schema) (n:nat) (pf:n< length I) : tname.
```

The operation of project a single attribute from a tuple uses `attType` in its type:

```
projTupleAtt (I: Schema) (n: nat) (pf: n < length I)
  (t: Tuple I) : tnameDenote (attType I n pf).
```

C. Relations

We can see relations as a finite set of types. Coq provides the "`FSets`" library composed of several packages. The library is coded as a standard ML-style functor i.e., as first order parametric *module*, which requires the static determination of the corresponding module's signature².

Then, the choice that we consider is how to represent finite sets in Coq. We assume that we could not use the "`FSets`" library directly. Because in *Rel DBMS*, the relation type must be computed from a schema at run-time, not before; obviously, it does not know table schemas until the user loads data at run-time (since modules signature has been already defined). For this, rather than try to encode such behavior using just *modules*, we modified the `FSet` library to be first-class using Coq's type class mechanism [27].

Type classes are a recent addition to Coq presented as a solution to allow user overloading notations, operations and specifying with abstract structures by quantification on contexts³ across a class of types. They behave similarly to their Haskell counterparts which have been introduced to make ad-hoc polymorphism less ad hoc [28]. In informal semantic similarities description, we can say that Coq's type class plays the role of relation variable *relvar* presented in Section II. Classes instantiation is similar to the process of assigning some relations values to a given *relvar* having the same heading as also the same applied operators.

We establish our work of specification on the basis of the Library *Containers.SetInterface* that defines the interface of typeclass-based finite sets. We have a class of types *FSetInterface* that is parameterized by a type `elt` of elements and a total ordering `E` over `elt` that can be used as specifications of finite sets. Here "*Prop*" indicates Coq's *proposition* sort:

```
FProdTuples (I J: Schema)(x: Tuple I)(y: Tuple J)
  :
  Tuple (I ++ J).
```

```
Class FSetInterface (elt: Set) (E: OrderedType elt)
  : Type :=
  { Fset : Set; (* the container type of finite sets *)
    (* operations *)
    empty : Fset;
    union : Fset -> Fset -> Fset;
    inter : Fset -> Fset -> Fset;
    is_empty : Fset -> bool;
    add : elt -> Fset -> Fset;
    ...etc
    (* the predicates *)
  In : elt -> Fset -> Prop;
  Definition Equal '{Set elt} s s' => forall a : elt,
    In a s <-> In a s'; (* In is the membership
  function*)
  Definition Empty '{Set elt} s :=
    forall a : elt, ~ In a s.
```

We define the class *FSetInterface* of structures that implement finite sets. An instance of *FSetInterface* for an ordered type *E* contains the type *FSet* of elements *elt*. It also contains all the operations that these sets support: insertion, membership, etc. The specifications of these operations are in a different class. In addition, we specify a set of axioms that allow us to reason about the operations.

Thus, formal specification of a relation in Date and Darwen's model is defined over finite sets of schema typed tuples. Building relations requires defining a total ordering over tuples and interacting with the type class mechanism, and it is given as follows:

Definition Relation (I: Schema) :=
FSetInterface (Tuple I).

We must also indicate that this specification is realizable otherwise, which we can do by providing a simple implementation using lists. In this case, we require the element types to be ordered. An alternative implementation of a finite set would be as a sorted list with a proof that the list contains no duplicates.

In general, we have found that the richness of Coq, including support for ML-style modules, dependent types and type classes, coupled with abstraction and equality issues yields a set of tradeoffs that are difficult to evaluate.

D. Relational Algebra A

Date and Darwen have described a new relational algebra *A* [16]. The algebra *A* differs slightly from Codd's original algebra in some aspects but it is identical in a great part.

As defined by Date and Darwen, a database is modeled using relations. We can represent a relation as a finite set of tuples over a list of types [17]. New relations are constructed using a basis of operations: *Selection*, *Projection*, *Union*, *Permutation*, *Difference*, and *Cartesian product*.

This basis is relationally complete, and equal in expressive power to other relational formalisms, like relational calculus. We define the relational operations over relations. Then, we consider that formal specification of these relational operations will be given in terms of Coq's predefined functions. Though, we modify the definitions in such way that it will be adapted with the light changes introduced in Date and Darwen's definitions of Algebra *A*.

Union, *difference*, and *selection* are implemented in terms of the *FSetInterface* union, difference, and filter functions, respectively. In Tutorial D, union dyadic $r_1 \text{ UNION } r_2$ (where r_1, r_2 have the same headings) is semantically equivalent to the algebra *A* expression $r_1 \langle \text{OR} \rangle r_2$.

Projection and *product* are defined using the generic fold function provided by the *FSetInterface*. *Selection* allows any Coq predicate that respects the setoid equality of the schema to be used.

Projection is implemented by iterating through a set, projecting out each tuple individually. *Cartesian product* is slightly more complicated, requiring two iterations. To compute the product of two relations r_1 and r_2 , for each $x \in r_1$ we compute the set $\{\text{FProdTuples } x \ y \mid y \in r_2\}$ and then union the results.

We have indicated that our main mission will concern the verification task, that is showing that the *Rel DBMS* executes correctly queries with respect to a denotational semantics of Tutorial D and relations. Therefore, we need some lemmas to support basic reasoning.

To prove the accuracy of our specified relational Algebra, we have shown that several standard equivalences are derivable from our definitions. Some equivalences are universally valid; for example, the commutativity of *selection*:

$$\text{Select P1 (select P2 R)} = \text{select P2 (select P1 R)}$$

Other equivalences only apply in the presence of constraints on relations. For example, let r_1 and r_2 be relations over schemas *I* and *J*, respectively, and let *l* indicate the attributes $0 \dots |l| - 1$. We have the conditional equivalences:

$$\begin{aligned} r_2 \langle \neq \rangle \text{empty} &\rightarrow \text{proj } l (\text{prod } r_1 \ r_2) = r_1 \\ r_2 = \text{empty} &\rightarrow \text{proj } l (\text{prod } r_1 \ r_2) = \text{empty} \end{aligned}$$

Proving this statement requires reasoning about how projection of *l* can be effectuated through the nested iteration that defines the product. it may be possible to adapt an automated theorem prover for

relations (e.g., [29]) to Coq to reduce the proof complexity.

Challenges

In what follows we highlight some challenges from our work of specification.

Use dependent types in our definitions was a source of difficulties. We found dependency useful to express schemas for operations and to rule out various error cases that would arise. Newer languages such as Epigram [30] provide better support for programming with dependent types. For Coq, several works ongoing to adapt many of these ideas, so we are hopeful that these difficulties will diminish.

Another challenge is that the Coq modules are useful for controlling name spaces, but their second-class nature makes it difficult to use them effectively for abstraction. Rather, we found core language mechanisms, such as dependent records and type classes, to be more useful than modules. Consequently, we avoided sophisticated use of the module system when possible.

A final challenge is the formalization of algebra A. The inspiration for our work, however, is the formalization of the relational algebra in Agda found in [26]. Like that work, we use axiomatic finite sets; however, we opted for a more concrete tuple representation and a different, but equivalent, choice of base operations.

Conclusion

In this paper, we have given a formal specification of some key concept of that model using one of the most famous proof assistant system namely Coq proof assistant [19].

We declare that we have settled for merely a few basic concepts but our study of formalization and formal specification constitute a preamble step to a complete demarche toward a verified object / relational data model and subsequently toward verified data bases management system.

The implementation of the concepts of Date and Darwen in a DBMS is in full experimentation around the world, for instance the DBMS *Rel* that implements a significant portion of [Date](#) and [Darwen's Tutorial D query language](#). Thus, the verification of this system appears necessary to prove its power and reliability in terms of correctness of development and in terms of security requirements during its running on complex environment and applications. What's persists in our future work concerns especially the verification tasks, that is to say verifying that queries in *Rel* are executed correctly according to their specification.

Writing a formal specification is already an improvement compared to standard approaches. Indeed, by using Coq proof assistant system, many ambiguities are resolved. Furthermore, Coq provide ways to check consistency of the specification

allowing large complicated proofs. Thus, using software to assist formal specification and verification has been of great impact in whole process of development.

References

- [1] S. [Vangalur, Alagar](#), V. S. [Lakshmanan](#), F. [Sadri](#) (Eds.), "Formal Methods in Databases and Software Engineering", Proceedings of the Workshop on Formal Methods in Databases and Software Engineering, Montreal, Canada, 15-16 May 1992.
- [2] É. Jaeger, [T. Hardin](#), "A Few Remarks About Formal Development of Secure Systems", [CoRR abs/0902.3861](#): 2009.
- [3] A. van Lamsweerde, "Building Formal Models for Software Requirements", [APSEC 2000](#): 134- 7th Asia-Pacific Software Engineering Conference (APSEC 2000), 5-8 December 2000, Singapore. IEEE Computer Society 2000.
- [4] D. Bell, D, "Foundations and Model". M74- 244, The MITRE Corp., Bedford MA,E. and LaPadula, L.J. Secure Computer Systems: Mathematical. May 1973
- [5] W. Cheng, X. Zhang, J. Liu, "A Secure Policy Model for Secure Database System Based on Extended Object Hierarchy", *Journal of Software*, vol.14, No.5, 2003.
- [6] U. Sonali; Bibighaus, David; Dinolt, George; Levin. E. Timothy, "Evaluation of Program Specification and Verification Tools for High Assurance Development". Naval Postgraduate School (U.S.) 2003-09-00 [Information Systems Security Studies and Research \(CISR\) Papers](#).
- [7] J. Park, J. Choi, "Formal Security Policy Model for a Common Criteria Evaluation," *ICACT2007*,pp.277-281, Feb. 12-14, 2007.
- [8] E. M. Clarke, [J. M. Wing](#), "Formal Methods: State of the Art and Future Directions". [ACM Comput. Surv.](#) **28**(4): 626-643 (1996).
- [9] A.van Lamsweerde, "Formal specification: a roadmap", [ICSE - Future of SE Track 2000](#): 147-159. 22nd International Conference on Software Engineering, Future of Software Engineering Track, ICSE 2000, Limerick Ireland, June 4-11, 2000. ACM 2000
- [10] A. [Bayley](#), H. Zhu, "Formal specification of the variants and behavioural features of design patterns". [Journal of Systems and Software](#) **83**(2): 209-221, 2010.
- [11] J. Julliand O. Kouchnarenko, Eds., B 2007," Formal Specification and Development in B", 7th International Conference of B Users, Besanc,on, France, January 17-19, 2007, Proceedings, ser. Lecture Notes in Computer Science, vol. 4355. Springer, 2006.
- [12] P. Frey, R. Radhakrishnan, H. Carter," A Formal Specification and Verification Framework for Time Warp-Based Parallel Simulation", *IEEE Transaction on Software Engineering*. Vol. 28, No. 1, January 2002
- [13] S. Owre , N. Shankar," A Brief Overview of PVS",. Theorem Proving in Higher Order Logics Lecture Notes in Computer Science, , Volume 5170/2008, 22-27, 2008.
- [14] Y. Bertot, "A Short Presentation of Coq", Theorem Proving in Higher Order Logics Lecture Notes in Computer Science, Volume 5170/2008, 12-16, 2008
- [15] K. Slind ,M. Norrish, "A Brief Overview of HOL4", Theorem Proving in Higher Order Logics Lecture Notes in Computer Science, Volume 5170/2008, 28-32,2008.
- [16] C.J. Date, H. Darwen, "Databases, Types, and Relational Model: The Third Manifesto", (3 rd edition); Addison-Wesley, 2007.
- [17] A. Benabbou, S.Nait Bahloul, Y.Amghar, K. Rahmouni," Generation of an Orthogonal Object / Relational type system", *Wotic 2009, WorkShop*

- international sur les Technologies de l'Information et de la Communication 24 – 25, Agadir, Maroc, Décembre 2009.
- [18] A.Benabbou, S.Nait Bahloul, Y.Amghar, K. Rahmouni, "Semantic expression of incomplete information in the object / relational model", 1st SIGSPATIAL ACM GIS 2009 International Workshop on Querying and Mining Uncertain Spatio-Temporal Data November 3, 2009, Seattle, WA, USA.
 - [19] The Coq development team, The Coq proof assistant reference manual, LogiCal Project, 2012. [Online]. Available: <http://coq.inria.fr>
 - [20] J.H. Gallier, "on the Correspondence between Proofs and lambda-Terms", Technical Reports (CIS) Scholarly Commons university of University of Pennsylvania. 1993.
 - [21] M. Heine Sørensen, P. Urzyczyn, "Lectures on the curry-howard isomorphism". University of Copenhagen 1998.
 - [22] Y. Bertot , P. Castéran , G. Huet , C. Paulin-Mohring, "Interactive Theorem Proving and Program Development: Coq'Art: The Calculus of Inductive Constructions" (Texts in Theoretical Computer Science). Springer; 1 edition, 2004.
 - [23] H. Barendregt, "Lambda Calculi with Types", Handbook of Logic in Computer Science, Volume 1, Abramsky, Gabbay, Maibaum (Eds.), Clarendon 1992.
 - [24] A. Church, "A Formulation of the Simple Theory of Types", The Journal of Symbolic Logic, 1940
 - [25] P.R. Halmos, "Naive Set Theory", D. Van Nostrand Company, Princeton, NJ, 1960. Reprinted, Springer-Verlag, New York, NY, 1974.
 - [26] C. Gonzalia, "Relations in Dependent type Theory". PhD Thesis, Chalmers University of Technology, 2006.
 - [27] M. Sozeau, N. Oury. "First-Class Type Classes". In Otmane Ait Mohamed, C.M., Tahar, S., eds.: Theorem Proving in Higher Order Logics, 21th International Conference. Volume 5170 of Lecture Notes in Computer Science, Springer (2008) 278-293, August 18-21, 2008.
 - [28] P. Wadler, S. Blott. "How To Make ad-hoc Polymorphism Less ad hoc". In ACM Symposium on Principles of Programming Languages (POPL), Austin, Texas, pages 60–76, 1989.
 - [29] C. Sinz, "System description: Ara - an automatic theorem prover for relation algebras". In Proc. CADE-17, 2000.
 - [30] C. McBride, J. McKinna, "Epigram: Practical Programming with Dependent Types". [Advanced Functional Programming](#): 130-177, 2004.

Approach for Modelling and verification of flexible and adaptable businesses processes

MADANIMOHAMED¹, BEKKI KHADHIR¹

¹département de l'informatique, université ibn khaldoun tiaret
Mohamed_madani@yahoo.fr, Kh_bekki@yahoo.fr

Abstract— Nowadays, the business processes need to be more flexible, adaptable and secured. These three criteria increase the performances of applications inter organizations and guarantee their stability. For this purpose, we plan to re-examine the way of modeling the business processes so they will be flexible and adaptable. For that, as for the adaptation, we adopt separation between concerns. We separate the development of the functionality concern from the transversal concerns (eg: security, context). As for flexibility, we propose a new model of description of the business processes based on ECA rules (Event -Condition-Action). So, our approach of modeling the business processes is a multi concerns approach (Security, Interaction) based on our formalism suggested CECAETE (Concern, Event, Condition, Action, check Execution, Time, else Event). First, we govern any business rule as a CECAETE rule. Then, to verify the rules based business process, we build a graph of rules. This graph is based on the relationships between the rules of the same concerns and of different concerns. In this paper, we discuss also, the formal verification of the CECAETE rules based business process.

KEY WORDS : FLEXIBLE MODELING , BUSINESS PROCESS, THE SEPARATION OF ASPECTS, BUSINESS RULES, SECURITY , ECA RULES

1. INTRODUCTION

The service-oriented architecture (SOA) allows collaborating and sharing critical data. Web services are explicit software units that can through their interfaces to be described, published, and most importantly, composed (dynamically) using XML-based protocols (for example WSDL, UDDI, BPEL4WS, and WS-CDL) [1].

Today, the criteria of flexibility, adaptability and security become the essential criteria in the development of service-oriented applications [2].

The BPEL language, often used to model the business processes, is a static language, not adaptable, and it does not provide any support for the specification of either authorization policies or authorization constraints on the execution of activities composing a business processes [3].

The ECA Rules (Event-Condition-Action) were appeared firstly in the active databases. They have the following general semantic: when an event occurs, if the condition is

the action is executed. They are subsequently used in other application areas, namely: the active warehouses, the active networks and the business process

[1].

The use of ECA rules is very appreciated to insert the flexibility into the process modeling [4]. Generally, they are widely adopted to model the business rules. Furthermore, separation of concerns provides a way to separate development of the functionality and the crosscutting concerns (e.g., context, security). Its advantages are: transparency, evolution, understandability and scalability [2]. This principle became one of the basic principles in software engineering [5].

To incorporate flexibility and adaptability into a business

process design, and benefit of the advantages of separation of two concerns: security and interaction in business process modeling, we propose, in this paper, a new rule based model that wants to improve the flexibility, adaptability and verification of business process.

We inspire our approach of the relative works [6][7]. The first work uses a formalism named ECAPE to model flexible business processes, but it does not adopt the separation of concerns. The second work adopts the separation between the concerns security and interaction but it does not take into account the parameter Time in its formalism of modelling of business process. In our work, the parameter time appears important, in particular for the security concern, to avoid the inactivity of the processes and the intrusions.

In our approach, each business process is specified by a set of rules which use our formalism CECAETE (Concern, Event, Condition, Action, check Execution, Time, else Event) based on business rules. We describe our approach follows an example of car rental. In occur, the graph of rules will be built and analysed to verify and handle exceptions in the rules based business process.

This work is organized as follow:

In the second section, we present our new rules based model. It describes the steps of our

approach according to an example. Third and the four sections are devoted to the discussion of handling the exceptions in the process by analysing the graph of rules and by the formal verification. The Section 6 presents the related works. Finally, some concluding remarks and further required extensions of this work are given.

2. Multi concern Rules Based Modelling of flexible Business Process

Introduction

ECA formalism has been adopted by many languages for rules based modeling of business processes. This is justified by the fact that this formalism allows to integrate all types of business rules (constraints, derivation, production, and transformation). Business rules are seen as policies, laws and know-how to deal in any business.

The capture of business rules as ECA rules with the separation of concerns have many advantages [2], among others, (1) the inherent ability of adapting any concern rules before imposing them on running services or components; (2) the promotion of understandability of each concern in isolation and then the study of the coherent composition.

To get the flexibility, adaptability and the separation of concerns: interaction and security, we propose the formalism CECAETE. This formalism is described as follows:

TYPE Concern On Event IF
Condition DO Action

POINT Execution check

T Time

Post Event Event.

Its semantics is: for each concern (C), when the event (E) occurs, the activated rule evaluates the condition(C). The condition is either a Boolean expression or a SQL query on the database. If the condition is satisfied, the action (A) is executed. The time (T) indicates the time of execution, or the earlier time of execution or the later time of execution. The event takes place after the activation of the rule, to activate the other rules or to send a message.

b. Example:

To understand our approach, we chose an example of car rental, as follows:

Having received customer's request, the system of rent of cars treats the request by the calculation of the Initial amount of rent, more to find a closest rental agency. When these two procedures end, an estimated bill is sent to the customer. In case of acceptance, the customer has to sign a rental agreement, then an bill final is emitted to the customer. Finally the bill is registered.

Constraints that exist in this scenario:

04 security constraints and 01 interaction constraint. The security constraints are:

- 1) The client must be authenticated in the system of car rentals.
- 2) The client must be authenticated in the system of the bank.
- 3) If the rental period is exceeded a certain day "d", the customer must be authorized by the regional chief of the agency.
- 4) Before receiving the final bill, the customer signs numerically the lease.

The constraint interaction is that the amount of the customer must equal or exceed the amount of the bill amount + an amount "m" (deposit amount). The **fig 1** show The modeling of this example.

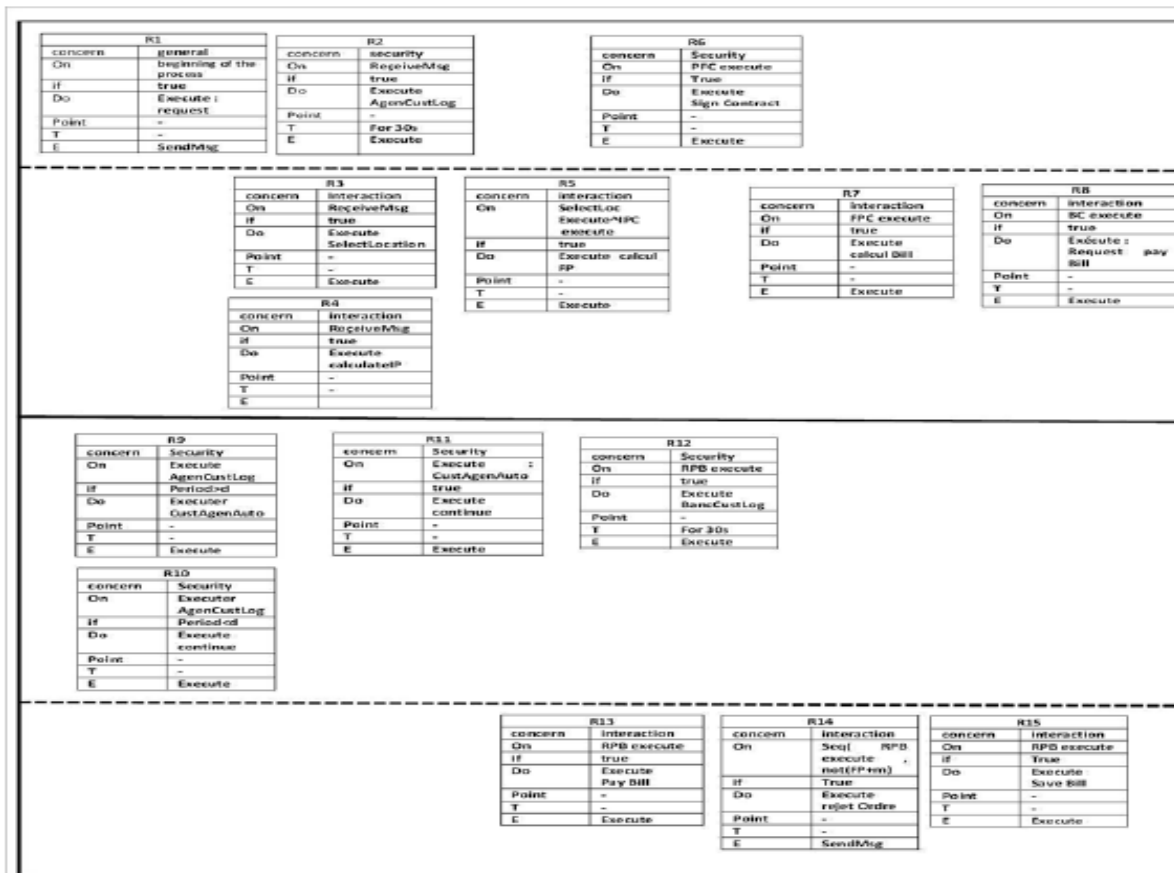

Fig.1 les règles CECAETE de location de voiture

processes:

The model above represents the business process management of car rental as a set of rules CECAETE. Business rules are governed separately on two concerns or views. The security view and the interaction view. The separation of concerns promotes the understandability of each concern in isolation.

For example, the rules R2, R6, R9, R10, R11 and R12 are of security concern that governs security constraints. These rules can be modeled by an expert of security, independently of the other concerns. Other rules can be modeled by an expert in the functional concern.

In this model, the rules R2, R3, R4 have the same event to activate which is the beginning of the process.

The process is started when the arrival of an event (eg clicking on the button "Rent"). However, they cannot be activated at the same time, because they are of two different concerns. The security concern has a higher priority. Accordingly, the rule R2 is activated before the rules R3 and R4. Moreover, the rules R3 and R4 cannot be activated if the rule R2 is not activated successfully or not validated. In case of success, the rules R3, R4 are executed at the same time because they are of the same concern.

Exception handling of business processes consists in discovering the functional errors on the process and the risks in changing of rules. These risks may be exceptions raised at run time like infinite loop and process non-repudiation, services deny.

To ensure reliability of business processes for the treatment of exceptions, we try to identify exceptions at modelling and at runtime. The detection of errors is too early useful for designers to verify their modelling at high-level. However, the identification of the functional errors must have a state of process data and a scenario execution. But it is often difficult to get this information when modelling [5]. According to the work [6] [7], we draw a graph rule-based causal relationships between these rules. In simple terms, a rule A causes a rule B if A produces a triggering event B or B does not run if A does not run correctly. For our example, the graph becomes:

3. Exception handling of business

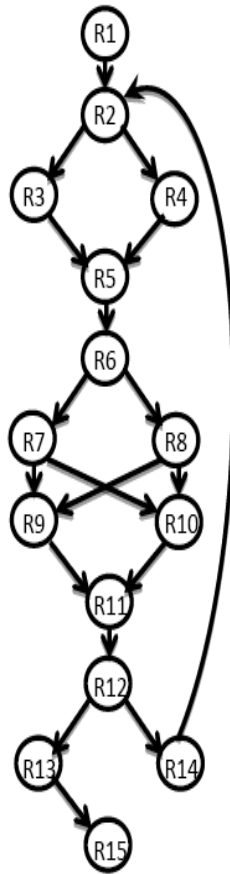

Fig 1. . Relationships graph execution

During the modelling, if we detect a cycle in the graph, it means there is the risk of live lock. We annotate this exception on the attribute CheckPoint. As for the security concern, the expert can annotate the rules that have more risk of intrusion or non-repudiation, as the rules of authentication, authorization and of the digital signature. During the execution, the system executes a specific treatment for the annotated rules, to verify the presence of the exemptions and launch the necessary treatment. In our example, the rules are annotated:

R2	
concern	Security
On	ReçeiveMsg
if	True
Do	Execute AgenCustLog
Point	Risk of intrusion
T	For 30s
E	Execute

R12	
concern	Security
On	RPB execute
if	true
Do	Execute BancCustLog
Point	Risk of intrusion
T	For 30s
E	Execute

R14	
concern	interaction
On	Seq(RPB execute , not(FP+m)
if	True
Do	Execute reje Order
Point	LiveLock
T	-
E	SendMsg

R6	
Concern	Security
On	PFC execute
If	True
Do	Execute Sign Contract
Point	Non-repudiation
T	-
E	Execute

Fig 3. Rules Marked

4. Formal verification of CECAETE Rules based process

Petri net is widely applied in the verification of business process modeling. To do a formal verification of the CECAETE Rules based business process, we found that the ECATNets[8] is the most appropriate Petri net to model it. EcatNets has conditions before and after to fire transitions and it is flexible.

Extended Concurrent Algebraic Term Nets (ECATNets for short) are a kind of high level algebraic nets combining the expressive power of Petri nets and of abstract data types [8,9].

ECATNets semantics is defined in terms of rewriting logic (RL). [10]. Such semantics provides a sound basis for rigorous verification of system properties. RL has been proved very appropriate for dealing with concurrent systems.

Further strengths is its practicability through the efficient MAUDE language [11].

The follow figure shows the EcatNet

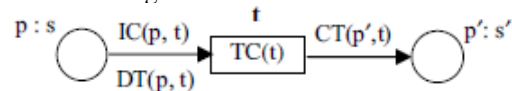

Fig 4 A generic representation of an EcatNet

P is a finite set of places.

T is a finite set of transitions

IC is Input condition, for a given transition t, the expression IC(p, t) specifies conditions on the marking of an input place p for the enabling of t.

DT is Destroyed Tokens. The expression $DT(p, t)$ specifies the multiset of tokens to be removed from the marking of the input place p when t is fired.

CT is Created Tokens. The expression $CT(p', t)$ specifies the multiset of tokens to be created in the output place p' , when t is fired.

TC is Transition Condition. The expression $TC(t)$ is a Boolean term which specifies an additional enabling condition for the transition t . $TC(t)$ specifies some conditions on the values taken by local variables of t (variables related to the all input places of t). Note that when $TC(t)$ is omitted, the default value is the term True.

An interesting feature of ECATNets is that there is a clear distinction between the firing condition of a given transition t and the tokens which may be destroyed during the firing action of t (respectively specified via the expression $IC(p, t)$ and $DT(p, t)$). A transition t is fireable when several conditions are satisfied simultaneously: (1) Every $IC(p, t)$ is satisfied for each input place p of t . (2) The transition condition $TC(t)$ is true. When t fires, $DT(p, t)$ tokens are removed from the input place p and simultaneously $CT(p', t)$ tokens are added to the output place p' .

In Maude object states in are conceived as terms — precisely as tuples of the form $Id : C[at1 : v1, ..., atk : vk]$. In this tuple : Id stands for object identity; C identifies an object class; and $at1, ..., atk$ denote attribute identifiers with $v1, ..., vk$ as current values. Messages are regarded as operations sent or received by objects, and their generic sort is denoted Msg . Object and message instances flow together in the so-called configuration, which is a multiset, w.r.t. an associative commutative operator denoted by $'--'$, of messages and (a set of) objects. The effect of messages on objects is captured by appropriate rewrite rules [2].

The verification process consists of the following steps:

- 1.Acquisition of business process based on rules.
- 2.Transformation the CECAETE rules to ECATNets.
- 3.Description of ECATNets in rewriting logic.
- 4.Verification of the generated description with the MAUDE tool.

After a careful analysis of the properties of CECAPNETE

and ECATNETs and inspired from [12], we propose a transformation of the CECAETE to ECATNETs shown in the following table:

CECAETE		ECATNET
Type	Concern	Type of marking
On	Evtnt	Event
If	Condition	Input condition (IC)
Do	Action	Destroyed token (DT)
Time	Time-condition	Transition condition
Point	Execution-check	-
Post-event	Trigger	Created token (CT) +

Fig 5 Transformation the rules of CECAPNETE To ECATNETs

The formal verification of CECAETE rules based business process consist to verify the functional exceptions and properties like: Deadlock, Live lock, Boundness and controllability.

The detail of the verification is not given in this paper.

5. Related work:

In [13], the authors of this paper made a comparison between two approaches of modelling of business processes. Graph-Based Process Modelling Approaches and Rule- Based Process Modelling Approaches. In the 1st approach, the activities are represented as nodes and the dependencies between them such as arcs. In the 2nd approach, process logic is abstracted into a set of rules, each of which is associated with one or more business activity, specifying properties of the activity such as the pre and post conditions of execution.

After a comparative study between both approaches [13], the authors deduce that Rule-Based Approaches are more flexible and more adaptable.

In [7], the authors of this article proposed a multi concern approach to model flexible business process. But, they didn't capture the time attribute and they haven't done a formal verification of the modelling.

In [6], the authors defined a new a framework of the modelling business process it's the model "ECAPE" with the aim of transforming a process in a graph of rule which can be analysed in term of reliability and flexibility. But in this model, they used a single view and did not adopt the

separation between concerns.

6. Conclusions and future work

In this paper, we proposed a new model for describing business processes rules-based ECA, which improves flexibility and adaptability of business processes, enjoying the benefits of the separation of two concerns: Security and Interaction. The approach is fully illustrated using an example of a rental car. In future, we will experiment this approach with more complex examples of E-commerce.

Using the aspect programming, we can extend our work by a transformation of the modelling to an aspect oriented code.

7. REFERENCES:

1. OASIS SOA Reference Model TC :

http://www.oasisopen.org/committees/tc_home.php?wg_abbrev=soa-rm.

2. Nasreddine Aoumeur ,Kamel Barkaoui ,Gunter Saake A multi-dimensional architectural approach to behavior- intensive adaptive pervasive applications, Proceeding ISWPC'09 Proceedings of the 4th international conference on Wireless pervasive computing, IEEE Press Piscataway, NJ, USA ©2009

3. Mohamed Boukhebouze, Youssef Amghar, Aïcha-Nabila Benharkat, and Zakaria Maamar. Towards Self-healing Execution of Business Processes Based on Rules. Springer- Verlag, 2009.

4. G.-J. Ahn, R. Sandhu, M. Kang, and J. Park. Injecting RBAC to secure a web-based workflow system. In Proceedings of the 5th ACM Workshop on Role-Based Access Control, pages 1–10, 2000

5. Raman Kazhamiakin, Salima Benbernou, Luciano Baresi, Pierluigi Plebani, Maïke Uhlig and Olivier Barai. Adaptation of Service-Based Systems Service Research Challenges and Solutions for the Future Internet, Lecture Notes in Computer Science, 2010,

6. M Boukhebouze, Y. Amghar, A. Benharkat, Z. Maamar. A Rule-based Approach to Model and Verify Flexible Business Processes. : International Journal of Business Process Integration and Management: IJBPIIM (). 2010

7. Khadhir Bekki, Hafida Belbachir. A flexible way for adaptive secured service-oriented business processes modelling. Proceedings of the 2011 International Conference on Intelligent Semantic Web-Services and Applications, ISWSA '11.

8. M, Bettaz and M, Maouche, “How to Specify Non Determinism and True

Concurrency with Algebraic Terms Nets“. In. LNCS 655, Bidoit, M., Choppy, C. (eds.), Springer-Verlag, Heidelberg, 1992, pp. 164 -180.

9. K. Barkaoui and A. Hicheur. “Towards Analysis of Flexible and Collaborative Workflow Using Recursive ECATNets”. (CBP'07), LNCS 4928, Springer Verlag, 2007, pp. 206-217.

10. J. Meseguer. Conditional rewriting logic as a unified model for concurrency. Theoretical Computer Science, 96:73–155, 1992.

11. M. Clavel, F. Duran, S. Eker, P. Lincoln, N. Marti-Oliet, J. Meseguer, and C.L: Talcott. All About Maude - A High- Performance Logical Framework, How to Specify, Program and Verify Systems in Rewriting Logic. Lecture Notes in Computer Science (springer), 4350, 2007.

12. Khadhir Bekki, Hafida Belbachir: A Flexible Integration of Security Concern in Rule Based Business Process Modeling., Proceedings of the 4th International conference on Web and Information Technologies, ICWIT 2012, Sidi Bel Abbes, Algeria, April 29-30, 2012

13. Ruopeng Lu and Shazia Sadiq, « A Survey of Comparative Business Process Modeling Approaches », In: Abramowicz, W. (ed.) BIS 2007. LNCS, vol. 4439, pp. 82–

94. Springer, Heidelberg (2007).

Driver Drowsiness Detection system based on Visual Information

Belal ALSHAQAQI ; Abdullah Salem BAQUHAIZEL ; Mohamed El Amine OUIS

Laboratory signals and images (LSI)

University of Sciences and Technology of Oran Mohamed Boudiaf (USTO-MB)

Oran, Algeria

alshaqaqi@ieee.org; abady939@yahoo.com; ouis57@gmail.com

Abstract—Drowsiness and Fatigue of drivers are amongst the significant causes of road accidents. Every year, they increase the amounts of deaths and fatalities injuries globally.

In this paper, a module for Advanced Driver Assistance System (ADAS) is presented to reduce the number of accidents due to drivers fatigue and hence increase the transportation safety; this system deals with automatic driver drowsiness detection based on visual information and Artificial Intelligence.

We proposed an algorithm to locate, track, and analyze both the drivers face and eyes to measure PERCLOS, a scientifically supported measure of drowsiness associated with slow eye closure.

Keywords—Drowsiness detection, ADAS, Face Detection and Tracking, Eyes Detection and Tracking, Eye state, PERCLOS.

1. INTRODUCTION

Currently, transport systems are an essential part of human activities. We all can be victim of drowsiness while driving, simply after a night's sleep too short, altered physical condition or during long journeys. The sensation of sleep reduces the driver's level of vigilance producing dangerous situations and increases the probability of an occurrence of accidents. Driver drowsiness and fatigue are among the important causes of road accidents. Every year, they increase the number of deaths and fatalities injuries globally.

In this context, it is important to use new technologies to design and build systems that are able to monitor drivers and to measure their level of attention during the entire process of driving.

In this paper, a module for ADAS (Advanced driver assistance System) is presented in order to reduce the number of accidents caused by driver fatigue and thus improve road safety. This system treats the automatic detection of driver drowsiness based on visual information and artificial intelligence.

We proposed an algorithm to locate, track and analyze both the driver face and eyes to measure PERCLOS (percentage of eye closure)

3 presents the proposed system and the implementation of each block of the system, the experimental results are shown in section 4 and in the last section conclusions and perspectives are presented.

2. RELATED WORKS

Some efforts have been reported in the literature on the development of the not-intrusive monitoring drowsiness systems based on the vision.

Malla et al. [1] develop a light-insensitive system. They used the Haar algorithm to detect objects [2] and face classifier implemented by [3] in OpenCV [4] libraries. Eye regions are derived from the facial region with anthropometric factors. Then, they detect the eyelid to measure the level of eye closure.

Vitabile et al. [5] implement a system to detect symptoms of driver drowsiness based on an infrared camera. By exploiting the phenomenon of bright pupils, an algorithm for detecting and tracking the driver's eyes has been developed. When drowsiness is detected, the system warns the driver with an alarm message.

Bhowmick et Kumar [6] use the Otsu thresholding [7] to extract face region. The localization of the eye is done by locating facial landmarks such as eyebrow and possible face center. Morphological operation and K-means is used for accurate eye segmentation. Then a set of shape features are calculated and trained using non-linear SVM to get the status of the eye.

Hong et al. [8] define a system for detecting the eye states in real time to identify the driver drowsiness state. The face region is detected based on the optimized Jones and Viola method [2]. The eye area is obtained by an horizontal projection. Finally, a new complexity function with a dynamic threshold to identify the eye state.

Tian et Qin [9] build a system that checks the driver eye states. Their system uses the Cb and Cr components of the YCbCr color space. This system locates the face with a vertical projection function, and the eyes with a horizontal projection function. Once the eyes are located the system calculates the eyes states using a function of complexity.

Under the light of what has been mentioned above, the identification of the driver drowsy state given by the PERCLOS is generally passed by the following stages:

- 1) Face detection,
- 2) Eyes Location,
- 3) Face and eyes tracking,
- 4) Identification of the eyes states,
- 5) Calculation of PERCLOS and identification the driver state.

3. THE PROPOSED SYSTEM

In this section, we discuss our presented system which detects driver drowsiness. The overall flowchart of our system is shown in Figure 1.

A. Face Detection

The symmetry is one of the most important facial features.

We modeled the symmetry in a digital image by a one-dimensional signal (vector accumulator) with a

size equal the width of the image, which gives us the value corresponding to the position of the vertical axis of symmetry of objects in the image. The traditional principle to calculate the signal of symmetry is for each two white pixels which are on the same line we increment the value in the medium between these two pixels in the accumulating vector. (The algorithm is applied on an edge image, we called a white pixel: the pixel with value 1).

We introduce improvements on the calculation algorithm of symmetry into an image to adapt it to the detection of face, by applying a set of rules to provide a better calculation of symmetry of the face. Instead of computing the symmetry between two white pixels in the image, it is calculated between two windows (Z1 and Z2) (Figure 2).

For each window Z1, we sweep the window Z2 in the area determined by the parameters S_min, S_max, and H. We increment the signal of symmetry between these two windows if the sum of white pixels is located between two thresholds S1 (maximum) and S2 (minimum).

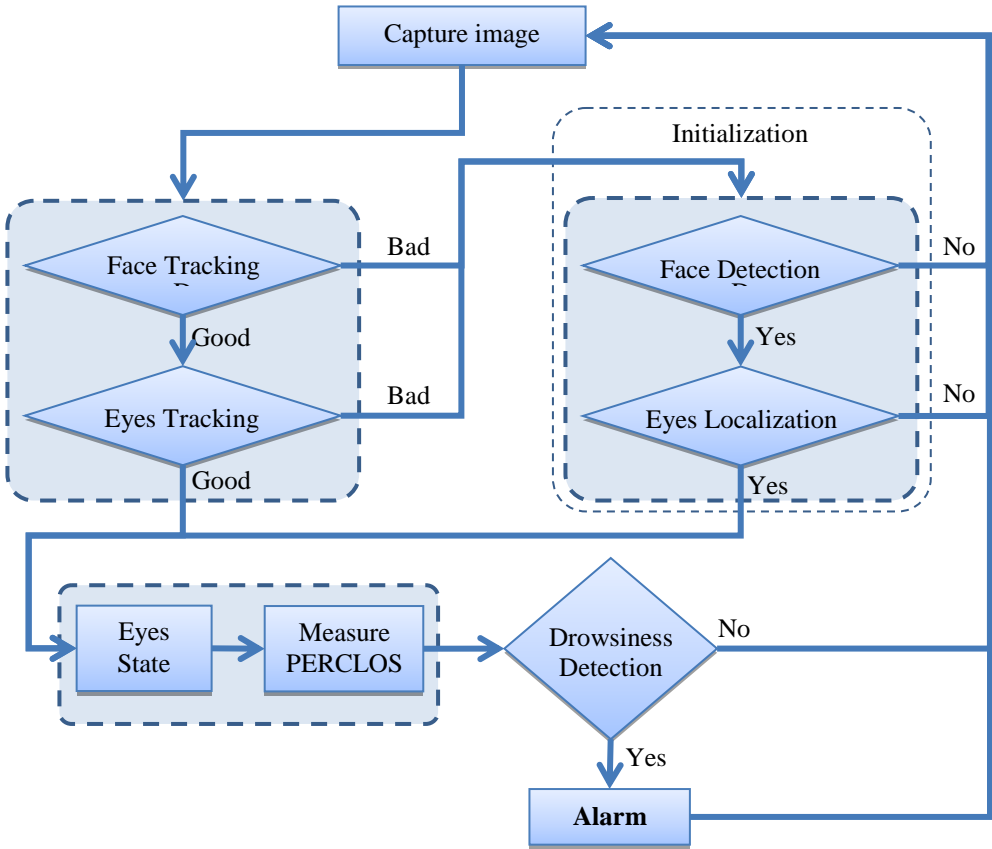

Figure 1 : Flowchart of the proposed system.

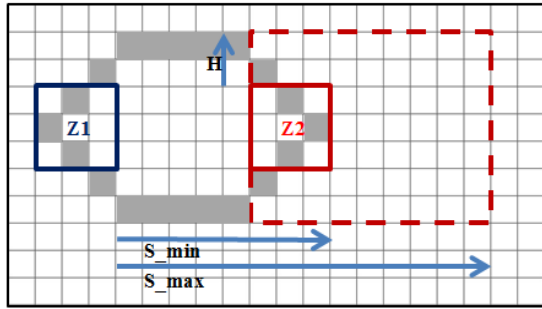

Figure 2 - The new method to improve the calculation of the symmetry in the image.

Then we extract the vertical region of the image contours (Region of Interest ROI) corresponding to the maximum index of the obtained signal of symmetry. Next, we take a rectangle with an estimated size of face (Because the camera is fixed and the driver moves in a limited zone so we can estimate the size of the face using the camera focal length after the step of camera calibration) and we scan the ROI by searching the region that contains the maximum energy corresponding to the face (Figure 3).

We propose a checking on two axes: the position variance of the face detected according to time; i.e., in several successive images, it is necessary that the variance of the positions of the detected face is limited; because the speed of movement of the face is limited of some pixels from a frame to another frame which follows.

B. Eyes Localization

Since the eyes are always in a defined area in the face (facial anthropometric properties), we limit our research in the area between the forehead and the mouth (Eye Region of Interest 'eROI') (Figure 4.a). We benefit from the symmetrical characteristic of the eyes to detect them in the face.

First, we sweep vertically the eROI by a rectangular mask with an estimated height of height of the eye and a width equal to the width of the face, and we calculate the symmetry.

The eye area corresponds to the position which has a high measurement of symmetry. Then, in this obtained region, we calculate the symmetry again in both left and right sides. The highest value corresponds to the center of the eye. The result is shown in Figure 4.b.

C. Tracking

The tracking is done by Template Matching using the SAD Algorithm (Sum of Absolute Differences).

$$SAD(x, y) = \sum_{j=1}^N \sum_{i=1}^M |I(x+i, y+j) - M(i, j)| \quad (1)$$

We proposed to make a regular update of the reference model M to adjust it every time when light

conditions changes while driving, by making a tracking test:

$$\text{Tracking} \begin{cases} \text{good} & \text{if } SAD \leq Th \\ \text{bad} & \text{if } SAD > Th \end{cases} \quad (2)$$

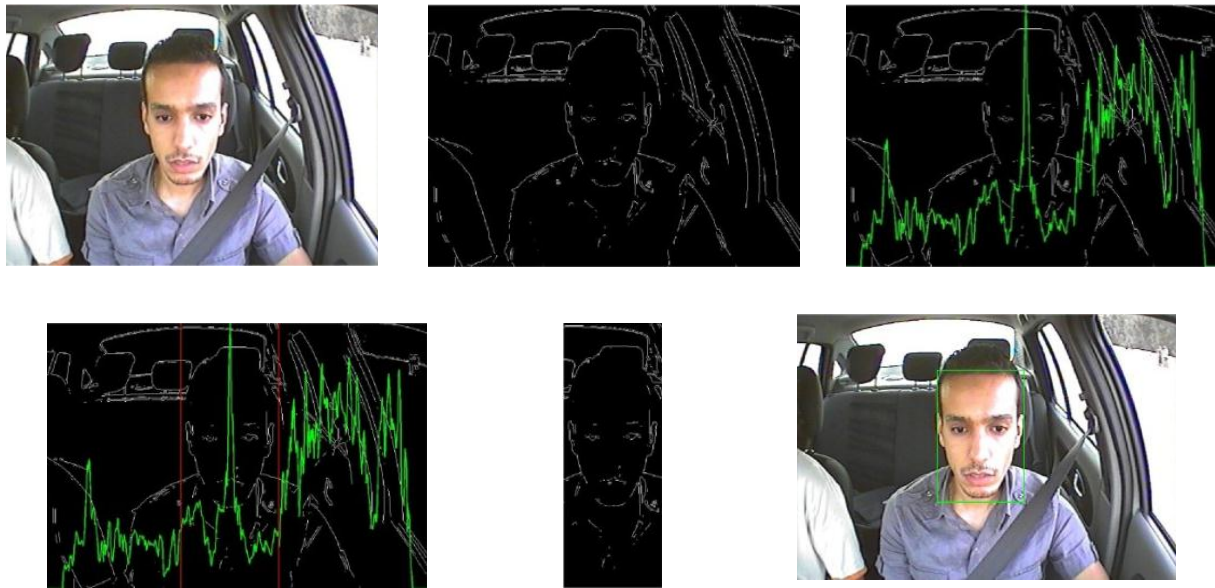

Figure 3 – Face detection using symmetry. (a) Original image, (b) Edge detection, (c) Symmetry signal, (d) Localization of the maximum of symmetry, (e) Region of interest ROI (f) Result.

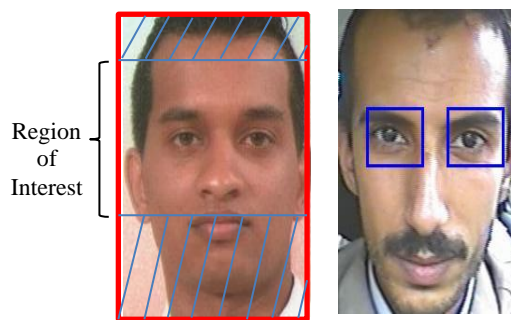

Figure 4 – Eyes localization using symmetry. (a) eROI, (b) Result.

D. Eyes States

The determination of the eye state is to classify the eye into two states: open or closed.

We use the Hough transform for circles [10] (HTC) on the image of the eye to detect the iris. For that, we apply the HTC to the edge image of the eye to detect the circles with defined rays, and we take at the end the circle which has the highest value in the accumulator of Hough for all the rays.

Then, we apply the logical 'AND' logic between edges image and complete circle obtained by the HTC by measuring the intersection level between them "S".

Finally, the eye state "State_{eye}" is defined by testing the value "S" by a threshold:

$$State_{eye} = \begin{cases} Open & \text{if } S \geq Th \\ Closed & \text{if } S < Th \end{cases} \quad (3)$$

The results are shown in Figure 5.

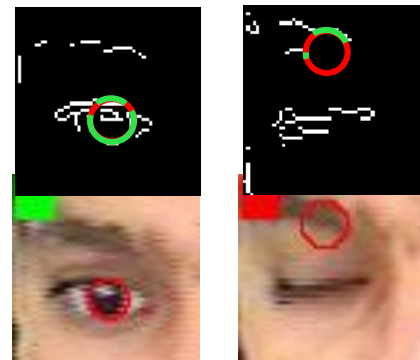

Figure 5 – Eyes states using HTC.

(a) and (b) Edge detection , (c) and (d) Eyes states results.

E. Driver State

We determine the driver state by measuring PERCLOS. If the driver closed his eyes in at least 5 successive frames several times over a period of up to 5 seconds, it is considered drowsy.

4. EXPERIMENTAL RESULTS

To validate our system (Figure 6), we test on several drivers in the car with real driving conditions. We use an IR camera with infrared lighting system operates automatically under the conditions of reduced luminosity and night even in total darkness.

The results of the eye states are illustrated in Table 1.

According to the obtained results, our system can determine the eye states with a high rate of correct decision.



Figure 6 - Our system installed in the car based on IR camera

TABLE 1 – RESULTS OBTAINED FROM THE SYSTEM.

Driver	frames Number	False Eyes sates		false rate
		Open	Closed	
D1/day	420	17	0	4 %
D2/day	430	15	0	3.5 %
D3/day	245	7	1	3.2 %
D1/night	200	3	1	2 %
D2/night	200	1	0	0.5 %
D3/night	200	6	3	4.5 %

5. CONCLUSION AND PERSPECTIVES

In this paper, we presented the conception and implementation of a system for detecting driver drowsiness based on vision that aims to warn the driver if he is in drowsy state.

This system is able to determine the driver state under real day and night conditions using IR camera. Face and eyes detection are implemented based on symmetry. Hough Transform for Circles is used for the decision of the eyes states.

The results are satisfactory with an opportunity for improvement in face detection using other techniques concerning the calculation of symmetry.

Moreover, we will implement our algorithm on a DSP (Digital Signal Processor) to create an autonomous system working in real time.

REFERENCES

- [1] [1] A. Malla, P. Davidson, P. Bones, R. Green and R. Jones, "Automated Video-based Measurement of Eye Closure for Detecting Behavioral Microsleep", in 32nd Annual International Conference of the IEEE, Buenos Aires, Argentina, 2010.
- [2] [2] P. Viola and M. Jones, "Rapid Object Detection using a Boosted Cascade of Simple Features", in Proceedings of the IEEE Computer Society Conference on Computer Vision and Pattern Recognition, 2001.
- [3] [3] R. Lienhart and J. Maydt, "An Extended Set of Haar-like Features for Rapid Object Detection", in Proceedings of the IEEE International Conference on Image Processing, 2002.
- [4] [4] OpenCV. Open Source Computer Vision Library Reference Manual, 2001.
- [5] [5] S. Vitabile, A. Paola and F. Sorbello, "Bright Pupil Detection in an Embedded, Real-time Drowsiness Monitoring System", in 24th IEEE International Conference on Advanced Information Networking and Applications, 2010.
- [6] [6] B. Bhowmick and C. Kumar, "Detection and Classification of Eye State in IR Camera for Driver Drowsiness Identification", in Proceeding of the IEEE International Conference on Signal and Image Processing Applications, 2009.
- [7] [7] N. Otsu, "A Threshold Selection Method from Gray-Level Histograms", IEEE Transactions on Systems, Man and Cybernetics, pp. 62-66, 1979.
- [8] [8] T. Hong, H. Qin and Q. Sun, "An Improved Real Time Eye State Identification System in Driver Drowsiness Detection", in proceeding of the IEEE International Conference on Control and Automation, Guangzhou, CHINA, 2007.
- [9] [9] Z. Tian et H. Qin, "Real-time Driver's Eye State Detection", in Proceedings of the IEEE International Conference on Vehicular Electronics and Safety, October 2005.
- [10] M. S. Nixon and A. S. Aguado, Feature Extraction and Image Processing, 2nd ed., Jordan Hill, Oxford OX2 8DP, UK, 2008.

Road Traffic Mean Speed Estimation Using a Camera

Mohammed Abdessamad Bekhti, Belal Abdelaziz Ibrahim Alshaqaqi

University of Science and Technology of Oran Mohamed Boudiaf

Faculty of Electrical Engineering, Department of Electronics

Signal and Image Laboratory

Oran, Algeria

bmabdessamed@gmail.com, alshaqaqi@ieee.org

Abstract—Embedded systems become more and more present in our daily life. The validation of this kind of systems with time their evolution became fast and complex we focus on multiprocessor systems on chip (MPSoC) and exactly Quality of Service of Network on chip architecture (QNoC). The interconnection of communication modules (IP - Intellectual Property) constitutes a fundamental part during the design of such systems expressed in terms on band-width, latency, power consumption and reliability. The validation currently for MPSoC (with QNoC's basis) based on the logical simulation which it can't allow a global validation for this system even it is not adapted for the design of high level integration complex systems (Handicaps with respect to the concept *time to market*).

Keywords- *Intelligent Transportation Systems, object detection, object tracking, data fusion, distance and speed measurement, vehicle countin.*

Introduction

Traffic planners around the world are facing great challenges in the design of intelligent transportation systems of the future. Transport demand will continue to increase; reducing traffic congestion, air pollution and the number of accidents will always be the greatest concern. Performance of intelligent transport systems is crucial for the possibilities for individual mobility, business, and economic growth of a nation. An intelligent transportation system operates according to internal procedures to perform defined tasks, among them, vehicle detection, vehicle tracking, and speed measurement. The first step in almost every video surveillance systems is the detection of moving objects. The object detection is the segmentation of the regions corresponding to moving objects from the rest of the image. Subsequent processes such as object tracking depend strongly. A mistake made at this stage is difficult to correct in the following steps. Several approaches exist for detection, among them, those based on characteristics such as symmetry in [1, 2], color in [3], shadow in [4], corners in [5], vehicle lighting in [6], and texture in [7]. Others approaches are based on stereo vision as in [8, 9], while others are based on movement estimation [10]. The system proposed here is based on background subtraction for the detection of vehicles. Among the techniques used, we find the basic background subtraction in

[11], the technique known as instantaneous background in [12], and the mixture of Gaussian in [13, 14].

In general, the aim of object tracking is to establish a correspondence between objects or parts of objects between successive frames to extract consistent time information about objects such as trajectory, posture, speed and direction. Among the approaches for tracking vehicles, there are those based on active contours [15, 16]. One technique is the Mean Shift algorithm introduced in [17] and modified for the purpose of tracking. As part of the dynamic approaches, the use of adaptive filters, such as using the algorithm RLS (Recursive Least Square) for vehicle tracking in [18]. In [19], a matching technique is used.

The rest of the paper is organized as follows. In section 2, the block diagram of the vision-based system is introduced. The major steps performed by the system will be discussed in detail in subsequent sections, including road modeling in Section 3, the detection of vehicles in Section 4, vehicle tracking in Section 5, data fusion in section 6, and finally the distance measurement in Section 7. After that, the experimental results will be introduced in Section 8. Concluding remarks are presented in Section 9.

vision based system for measuring distance and road traffic speed

The vision-based system for measuring the speed of the traffic proposed here consists of a camera, a computer, and a number of communications devices. The camera produces a continuous acquisition from a road. The video sequences are transmitted through the Internet to an FTP server where data are stored. The video sequences are processed at the computer level.

The camera can be installed on a bridge, or a higher pole. Figure.1 describes the configuration of the camera. Many parameters of the camera setup are given in the figure, including the tilt angle θ , the height h of the camera. The parameters θ , h , and the focal distance of the camera are known in advance.

A block diagram of the proposed vision-based system is presented in Figure. 2. Five major steps constitute the diagram, and are, modeling of the road, vehicle detection, vehicle tracking, data fusion, and speed measurement. The five steps are discussed in the following sections.

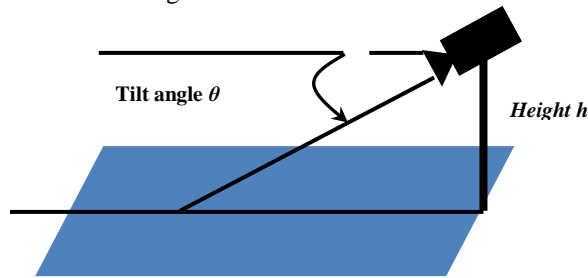

Figure. 1. Camera configuration.

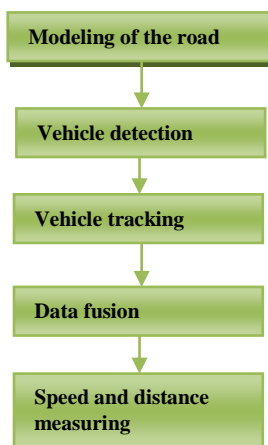

Figure. 2. Diagram of the vision based system.

modeling of the road

Modeling of the road is to extract the lines delimiting it and calculate their equation. This is done by the Hough transform. Data from this step will be used during the speed measurement. It begins by dividing the image scene into two scenes left and right, and apply to the latter the Hough transform. The result is given in Figure. 3.



Figure. 3. Road modeling using Hough Transform

detection of vehicles

In our case, the vehicle detection is based on the median filtering technique as in [20]. Let $I_n(x)$ the pixel intensity observed at position x at time n , and $m_n(x)$ the median estimate of the current background at the same position and time. The median approximation $m_{n+1}(x)$ is given as follows in equation (1):

$$m_{n+1}(x) = \begin{cases} m_n(x) + \alpha, & \text{si } I_n(x) > m_n(x) \\ m_n(x) - \alpha, & \text{si } I_n(x) < m_n(x) \\ m_n(x), & \text{si } I_n(x) = m_n(x) \end{cases}$$

(1)

Where α , whose value is between 0 and 1, is assigned according to the convergence rate desired. A pixel $I_n(x)$ is classified as stationary if it satisfies equation (2):

$$|I_n(x) - m_n(x)| < T$$

(2)

T is the threshold.

The result of this step is given by Figure.4 in (a), (b) and (c).

Generally, there is the presence of impurities, additional unwanted detections. To overcome these problems, morphological adjustments are applied to the object mask. The operation in question is opening, i.e., an erosion followed by dilation. The result is given in Figure. 4 (d). Although the opening ensures properly offset the problems mentioned above, there may be noise that still persists, and therefore confusion between moving objects and the latter. To minimize this effect, an object selection is made to retain only the objects of interest. The object selection consists in carrying out a labeling of the mask.

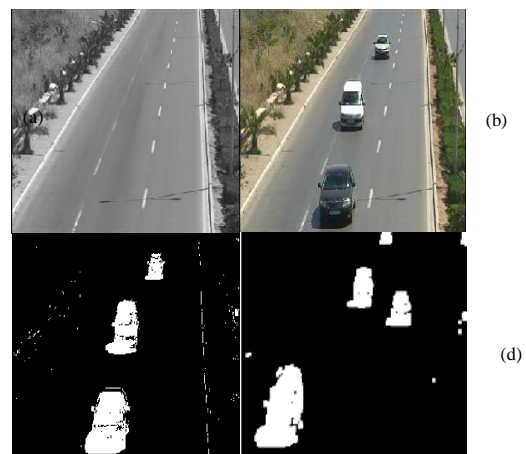

Figure. 4. Object segmentation by median approximation. (a) Estimated background, (b) Current frame, (c) Object mask, (d) Morphological operations.

After this, we calculate the number of pixels per lob. Only the lobes including a number of pixels satisfying

a threshold are selected for further processing. Figure.5 (a) shows the result of object selection.

vehicle tracking

The detected vehicles are tracked throughout the video sequence. To do this, the technique used is the search for agreement between the vehicles of each pair of successive images via corresponding more known as Matching.



Figure. 5. (a) Localisation des véhicules, (b) Suivi des véhicules par mise en correspondance.

This correspondence is based on the assessment of similarity by the correlation criterion. In this case, the correlation criterion chosen is the Sum of the Squares Differences (Sum of Squared Differences) given by equation (3). The result is given in Figure.5 (b).

$$SSD = \sum_{(i,j) \in F} (I_1(i, j) - I_2(i + x, j + y))^2 \quad (3)$$

data fusion

In the literature, we have seen that sometimes the authors associate two types of tracking algorithms to improve the result obtained when tracking objects. In this case, we found ourselves facing the problem of whether the tracking result is to some extent correct? In what follows, we will introduce the proposed solution for verifying the results of tracking. At time t , there are two crucial data, namely object detection and tracking of objects from the detection at time $t-1$. The aim is to be able to establish a relationship between these two information. Figure.6 introduces the principle of the approach.

L'opération de la fusion des données de détection et de suivi va permettre :

- **Répertorier les objets détectés à l'instant t selon trois catégorie, qui sont :**

- Category 1: an object in processing, i.e. that the object in question is still being tracked because it always appears in our field of vision. This category will gather all correspondence between the results of tracking and detection. This case is illustrated in the figure above by the arrows numbered 1 and 2.

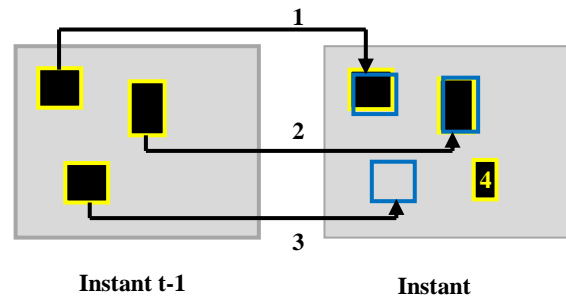

Figure. 6. Data fusion idea.

- Category 2: This category will list the main results of the tracking to which there is no corresponding detection. This case is encountered in two situations: first, poor detection leading that the object to be detected does not appear. The second, an object that is no longer in the area of interest. This case is shown in Figure above by the arrow 3.
- Category 3: any object from detection to which there is no correspondence among the tracking result is found. This case is shown in the figure by the object numbered 4.
- Assigning an identifier for objects of class 3, and inserting them into an identification table.

distance and speed measuring

Figure.7 illustrates how to calculate the distance from the road width. The two solid yellow lines represent the lower boundary of the object at times t_1 and t_2 . Computing the points of intersection of the line located at the lower boundary of the object with the two straight lines defining the road. The width of the road at that time is equal to the difference of the vertical component of the two points. Equation (4) give the width of the road at times t_1 .

$$T_1 = |j_1 - j_2| \quad (4)$$

The distance of the object at the instant t_1 is given by equation (5):

$$D_1 = f \frac{T_r}{T_1} \quad (5)$$

Where T_r represents the width of the road in meters and is fixed, and f is the focal distance of the camera.

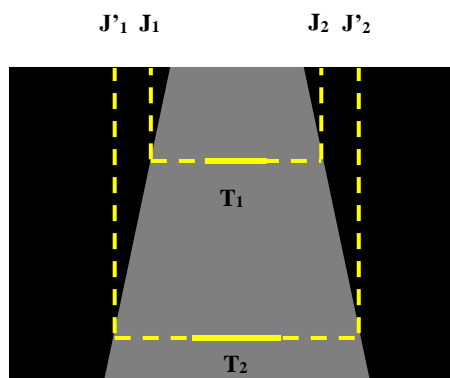

Figure. 7. Distance evaluation from road width.

experimental results

For a good discussion of the technique used for distance measurement, it is proposed to draw three horizontal lines on the image, and each line is given the estimated distance of the object relative to the camera. This operation is performed for three different vehicles.

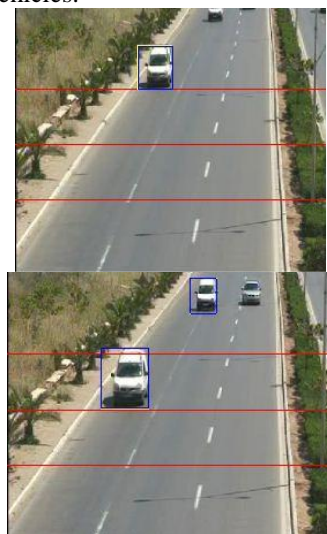

Figure.8. Procedure for validating distance evaluation results.

Table 1 introduces the test results, and Figure. 8 illustrates the method mentioned above.

TABLEAU 1: Distance measurement from the road width test results.

Test number	Distance of vehicle 1 (m)	Distance of vehicle 2 (m)	Distance of vehicle 3 (m)
1	39.13	38.41	39.13
2	29.43	29.71	30
3	24.13	24.23	24.13

In what follows, we propose to validate the accuracy of the results obtained above using sequences that were recorded in the University of Science and Technology, Mohammed Boudiaf Oran. The

sequence was taken using an analog CCD camera, and vehicles that appear in the field of vision are moving at a constant speed of 20 km / h. Figure.9 shows the driving speed by two vehicles. The following table introduces the counting result.



Figure. 9. Mean speed estimation results.

TABLEAU 2 : validating results of vehicle counting

Sequence number	Number of frames per sequence	Real number of vehicles	counting
1	1300	5	5
2	2253	25	25
3	1565	17	19

interpretation of results

- In our case, the detection has a direct influence on the measurement of speed and vehicle counts. One solution is to ignore the false detections, for this it is compulsory that a detected object appear for a period longer than 1 second, i.e. at least 30 images.
- Objects taken into account when processing are belonging to a size interval $[T_{min}, T_{max}]$, where T is the number of white pixel (part of the foreground). In this study case, T_{min} is equal to 650 pixels and T_{max} is equal to 1000 pixels.
- In practice, an object that moves must change size and position. In our implementation, for two successive images sometimes the object does not change size, consequently, the speed is influenced. One solution is to increase the resolution of the image and / or a lower image frequency.

conclusions and outlook

In this paper, we present a vision based system for measuring speeds and vehicle counts. The system relies on the use of a camera, a computer for processing, and a number of devices for communication, and installation. Several techniques such as detection lines for the delimitation of the road, the progressive generation of the background image, followed by the matching technique for

object tracking, data fusion to manage objects between successive frames, and estimation of speed. The sequences from our camera were used in various experiments. The system provides very satisfactory results under different climatic conditions. It is intended to improve the system by incorporating shadow eliminators and concealment for vehicles, a classifier for the categorization of vehicles, and the possibility to operate by night time.

References

- [1] A. Kuehnle, "Symmetry-Based Recognition for Vehicle Rears," *Pattern Recognition Letters*, vol. 12, pp. 249-258, 1991.
- [2] M. B. A. Benschrair, A. Broggi, P. Miche, S. Mousset, and G. Moulminet, "A Cooperative Approach to Vision-Based Vehicle Detection," *IEEE Intelligent Transportation Systems*, pp. 209 - 214, 2001.
- [3] S. D. Buluswar and B. A. Draper, "Color Machine Vision for Autonomous Vehicles," *Int'l J. Eng. Applications of Artificial Intelligence*, vol. 1, pp. 245-256, 1998.
- [4] C. Tzomakas and W. v. Seelen, "Vehicle Detection in Traffic Scenes Using Shadows," *Technical Report 98-06, Institutfu for Neuroinformatik, RuhrUniversitat, Bochum, Germany*, 1998.
- [5] M. Bertozzi, A. Broggi, and S. Castelluccio, "A Real-Time Oriented System for Vehicle Detection," *J. Systems Architecture*, pp. 317 - 325, 1997.
- [6] R. Cucchiara and M. Piccardi, "Vehicle Detection under Day and Night Illumination," *Proc. Int'l ICSC Symp. Intelligent Industrial Automation*, 1999.
- [7] T. Kalinke, C. Tzomakas, and W. V. Seelen, "A Texture-Based Object Detection and an Adaptive Model-Based Classification " *Procs. IEEE Intelligent Vehicles Symposium*, pp. 143 - 148 1998.
- [8] Y.-C. Lin, C.-C. Lin, L.-T. Chen, and C.-K. Chen, "Adaptive IPM-based lane filtering for night forward vehicle detection," *6th IEEE Conference on Industrial Electronics and Applications (ICIEA), 2011* pp. 1568 - 1573, 2011.
- [9] Y. Li, G. Toulminet, and A. Benschrair, "Vehicle detection based on the stereo concept of (axis, width, disparity) symmetry map," *IEEE ITSC - International Conference on Intelligent Transportation Systems*, pp. 778 - 783, 2008.
- [10] M. Bertozzi and A. Broggi, "GOLD: A Parallel Real Time Stereo Vision System for Generic Obstacle and Lane Detection," *IEEE TRANSACTIONS ON IMAGE PROCESSING*, vol. 7, 1998.
- [11] D. Hall, J. Nascimento, P. Ribeiro, E. Andrade, P. Moreno, S. Pesnel, T. List, R. Emonet, R. B. Fisher, J. S. Victor, and J. L. Crowley, "Comparison of target detection algorithms using adaptive background models," *INRIA Rhone-Alpes, France and IST Lisbon, Portugal and University of Edinburgh, UK*, pp. 585 - 601, 2005.
- [12] S. Gupte, O. Masoud, R. F. K. Martin, and N. P. Papanikolopoulos, "Detection and Classification of Vehicles," *IEEE TRANSACTIONS ON INTELLIGENT TRANSPORTATION SYSTEMS*, vol. 3, pp. 37 - 47, 2002.
- [13] C. Stauffer and W. E. L. Grimson, " Adaptive background mixture models for real time tracking," *IEEE Computer Society Conference on Computer Vision and Pattern Recognition*, vol. 2, 1999.
- [14] T. Yu-min and W. Xiao-tao, "A Fast Convergent Gaussian Mixture Model in Moving Object Detection with Shadow Elimination," *International Conference on E-Product E-Service and E-Entertainment (ICEEE)*, pp. 1- 4, 2010.
- [15] L. Ying-hong, P. Yi-gui, L. Zheng-xi, and L. Ya-li, "An Intelligent Tracking Technology Based on Kalman and Mean Shift Algorithm," *Second International Conference on Computer Modeling and Simulation*, vol. 1, pp. 107-109, 2010.
- [16] D. Keller, J. Weber, T. Huang, J. Malik, G. Ogasawara, B. Rae, and S. Russell, "Towards robust automatic traffic scene analysis in real time," *ICPR*, November 1994.
- [17] D. Comaniciu, V. Ramesh, and P. Meer, "Real-time tracking of non-rigid objects using mean shift," *Proceedings of the IEEE conference on computer vision and pattern recognition, Hilton Head, SC*, vol. 2, pp. 142-149, 2000.
- [18] H. S. Yazdi, M. Lotfiza, E. Kabir, and M. Fathy, "Clipped Input RLS Applied to Vehicle Tracking," *EURASIP Journal on Applied Signal Processing*, vol. 8, pp. 1221-1228, 2005.
- [19] X. C. He and N. H. C. Yung, "A Novel Algorithm for Estimating Vehicle Speed from Two Consecutive Images," *IEEE Workshop on Applications of Computer Vision (WACV'07)*, p. 12, 2007.
- [20] Z. He, Y. Liu, H. Yu, and X. Ye, "Optimized Algorithms for Traffic Information Collecting in an Embedded System," *Congress on Image and Signal Processing*, vol. 4, pp. 220-223, 2008.

Automatic Segmentation Approach based Possibility Theory for the Classification of Brain Tissues

Lamiche Chaabane
Department of Computer Science
University of M'sila Algeria
lamiche07@gmail.com

Moussaoui Abdelouahab
Department of Computer Science
University of Setif
moussaoui.abdel@gmail.com

Abstract—The paper presents a study and an evaluation of a novel unsupervised segmentation technique based aggregation approach and some possibility theory concepts. Information provided by different sources of MR images is extracted and modeled separately in each one using MPFCM (Modified Possibilistic Fuzzy C-Means) algorithm, extracted data obtained are combined with an operator which can managing the uncertainty and ambiguity in the images and the final segmented image is constructed in decision step. The efficiency of the proposed method is demonstrated by segmentation experiments using simulated MR Images.

Keywords— Aggregation, possibility theory, segmentation, MPFCM; MR images.

Introduction

Magnetic resonance (MR) imaging has been widely applied in biological research and diagnostics, primarily because of its excellent soft tissues contrast, non-invasive character, high spatial resolution and easy slice selection at any orientation. In many applications, its segmentation plays an important role on the following sides : (a) identifying anatomical areas of interest for diagnosis, treatment, or surgery planning paradigms; (b) preprocessing for multimodality image registration ; and (c) improved correlation of anatomical areas of interest with localized functional metrics [1].

Fully automatic brain tissue classification from magnetic resonance images (MRI) is of great importance for research and clinical study of much neurological pathology. The accurate segmentation of MR images into different tissue classes, especially gray matter (GM), white matter (WM) and cerebrospinal fluid (CSF), is an important task.

In medical imaging field, segmenting MR images has been found a quite hard problem due to the existence of image noise, partial volume effects, the presence of smoothly varying intensity inhomogeneity, and large amounts of data to be processed. To handle these difficulties, a large number of approaches have been studied, including fuzzy logic methods [3], neural networks [4], Markov random field methods with the maximum expectation [5], statistical methods [5], and data fusion methods [6], to name a few.

Here the evaluation of the full automatic segmentation of the human brain tissues using a multispectral aggregation approach is presented. This approach consists of the computation of fuzzy tissue maps extracted from each of three modalities of MR images T1, T2 and PD as an information source, the creation of fuzzy maps by a combination operator and a segmented image is computed in decision step.

The reminder of this paper is organized as follows : In section II, some previous related works are briefly cited. Section III summarize fuzzy clustering with the MPFCM algorithm. In section IV, we describe the principals of possibility theory reasoning. Section V describes the proposed process. Simulation results are introduced in Section VI. Conclusion is given in Section VII.

Related Works

A brief review of some related works in the field of fuzzy information fusion is presented in this section. Waltz [11] presented three basic levels of image data fusion : pixel level, feature level and decision level, which correspond to three processing architectures. I. Bloch [2] have outlined some features of Dempster-Shafer evidence theory, which can very useful for medical image fusion for classification, segmentation or recognition purposes. Examples were provided to show its ability to take into account a large variety of situations. Registration-based methods are considered as pixel-level fusion, such as MRI-PET (position emission tomography) data fusion[12]. Some techniques of knowledge-based segmentation can be considered as the feature-level fusion such as the methods proposed in [16].

Some belief functions, uncertainty theory, Dempster-Shafer theory are often used for decision-level fusion such as in [14]. In [17], I. Bloch proposed an unified framework of information fusion in the medical field based on the fuzzy sets, allow to represent and to process the numerical data as well as symbolic systems.

V. Barra and J. Y. Boire [9] have described a general framework of the fusion of anatomical and functional medical images. The aim of their work is to fuse anatomical and functional information coming from medical imaging, the fusion process is

performed in possibilistic logic frame, which allows for the management of uncertainty and imprecision inherent to the images. A new class of operators based on information theory and the whole process is finally illustrated in two clinical cases : the study of Alzheimer's disease by MR/SPECT fusion and the study of epilepsy with MR/PET/SPECT. The obtained results was very encouraging.

V. Barra and J. Y. Boire [15] proposed a new scheme of information fusion to segment intern cerebral structures. The information is provided by MR images and expert knowledge, and consists of constitution, morphological and topological characteristics of tissues. The fusion of multimodality images is used in [13]. In [8], the authors have presented a framework of fuzzy information fusion to automatically segment tumor areas of human brain from multispectral magnetic resonance imaging (MRI); in this approach three fuzzy models are introduced to represent tumor features for different MR image sequences and the fuzzy region growing is used to improve the fused result.

Maria del C. and al [10] proposed a new multispectral MRI data fusion technique for white matter lesion segmentation, in that a method is described and comparison with thresholding in FLAIR images is illustrated. Recently, The authors in [19] have presented a new framework of fuzzy information fusion using T2-weighted and proton density (PD) images to improve the brain tissue segmentation.

The MPFCM Algorithm Clustering

Clustering is the partitioning of unlabeled data set $X = \{x_1, x_2, x_3, \dots, x_n\} \in \mathcal{R}^p$ into $1 < c < n$ classes, by assigning labels to the vectors in X. A cluster contains similar patterns placed together. One of the most widely used clustering methods is the MPFCM (Modified Possibilistic Fuzzy C-Means) algorithm [20]. The MPFCM algorithm uses both the information of pixels and their neighborhoods, membership and typicality for classification. The MPFCM clustering algorithm minimizes the objective function :

$$J(U, T, V, X) = \sum_{i=1}^C \sum_{k=1}^N (au_{ik}^m + bt_{ik}^\eta) D_{ik} + \sum_{i=1}^C \gamma_i \sum_{k=1}^N (1 - t_{ik})^\eta + \beta \sum_{i=1}^C \sum_{k=1}^N (au_{ik}^m + bt_{ik}^\eta) S_{ik} \tag{1}$$

where $m > 1$ is the weighting exponent, $\lambda \in [3, 5]$ is the typicality exponent D_{jk} is the Euclidean distance between data x_j and cluster center v_i , $S_{ik} = \sum_{w=1}^{n_w} \|x_w - v_i\|$ where x_w is a neighbor pixel of x_k in a window around x_k and n_w is the number of

neighbors in this window., $[U]_{C \times N}$ is the fuzzy matrix where $\forall k, \sum_{i=1}^C u_{ik} \leq 1$. $[T]_{C \times N}$ is the typicality matrix where $\forall k, t_{ik} \leq 1$, $a > 0$, $b > 0$ are user defined constants and the parameter γ_i is given by :

$$\gamma_i = \frac{\sum_{k=1}^N D_{ik}}{\sum_{k=1}^N u_{ik}^m}, K > 1$$

The minimization of objective function $J(U, T, V, X)$ can be brought by an iterative process in which updating of membership degrees u_{ij} , typicality degrees t_{ij} and the cluster centers are done for each iteration by :

$$u_{ik} = \sum_{j=1}^C \left(\frac{D_{jk} + \beta S_{jk}}{D_{ik} + \beta S_{ik}} \right)^{1/(1-m)} \tag{2}$$

$$t_{ik} = \frac{1}{1 + \left(\frac{b}{\gamma_i} D_{ik} + \beta S_{ik} \right)^{1/(\eta-1)}} \tag{3}$$

$$v_i = \frac{\sum_{k=1}^N (au_{ik}^m + bt_{ik}^\eta)(x_k + \beta R_k)}{(1 + \alpha) \sum_{k=1}^N (au_{ik}^m + bt_{ik}^\eta)} \tag{4}$$

where : α and β are a given values and :

$$R_k = \sum_{w=1}^{n_w} x_w \tag{5}$$

The algorithm of the MPFCM consists then of the reiterated application of (2), (3) and (4) until stability of the solutions.

The Possibility Theory

Possibilistic logic was introduced by Zadeh (1978) following its former works in fuzzy logic (Zadeh, 1965) in order to simultaneously represent imprecise and uncertain knowledge. In fuzzy set theory, a fuzzy measure is a representation of the uncertainty, giving for each subset Y of the universe of discourse X a coefficient in [0,1] assessing the degree of certitude for the realization of the event Y. In possibilistic logic, this fuzzy measure is modeled as a measure of possibility Π satisfying:

$$\Pi(X) = 1 \quad \text{et} \quad \Pi(\emptyset) = 0$$

$$(\forall (Y_i)) \Pi(\cup_i Y_i) = \text{Sup}_i \Pi(Y_i)$$

An event Y is completely possible if $\Pi(Y) = 1$ and is impossible if $\Pi(Y) = 0$. Zadeh showed that Π could completely be defined from the assessment of the certitude on each singleton of X. Such a definition relies on the definition of a distribution of possibility π satisfying :

$$\pi : X \rightarrow [0,1] \\ x \rightarrow \pi(x) / \text{Sup}_x \{ \pi(x) = 1 \}$$

Fuzzy sets F can then be represented by distributions of possibility, from the definition of their characteristic function μ_F : $(\forall x \in X) \mu_F(x) = \pi(x)$

Distributions of possibility can mathematically be related to probabilities, and they moreover offer the capability to declare the ignorance about an event. Considering such an event A (e.g., voxel v belongs to tissue T , (where v is at the interface between two tissues), the probabilities would assign $P(A) = P(\bar{A}) = 0.5$, whereas the possibility theory allows fully possible $\Pi(A) = \Pi(\bar{A}) = 1$. We chose to model all the information using distributions of possibility, and equivalently we represented this information using fuzzy sets [21].

The three-steps fusion can be therefore described as :

- Modeling of information in a common theoretical frame ;
- The extracted information is then aggregated with a fusion operator F . This operator must affirm redundancy and manage the complementarities and conflicts.
- In the decision step, we pass from information provided by the sources to the choice of a decision.

Proposed Method

Modeling Step

Particularly, in our study this step consists in the creation of WM, GM, CSF and background (BG) fuzzy maps for both T1, T2 and PD images using the MPFCM algorithm.

Fusion Step

In this step, If $\pi_T^{T1}(v), \pi_T^{T2}(v), \pi_T^{PD}(v)$ are the memberships of a voxel v to tissue T resulting from step 1 then a fusion operator F combine these values to generate a new membership value and can managing the existing ambiguity and redundancy. The possibility theory propose a wide range of operators for the combination of memberships [7]. I. Bloch [18] classified these operators in three classes defined as: Context independent and constant behavior operators (CICB), Context independent and variable behavior operators (CIVB) and Context dependent operators (CD). For our MR images fusion, we chose a context-based conjunctive operator because in the medical context, both images were supposed to be almost everywhere concordant, except near boundaries between tissues and in pathologic areas. In addition, the context-based behavior allowed to take into account these ambiguous but diagnosis-relevant areas. Then we retained an operator of this class, this one is introduced in [18]:

If $\pi_T^{T1}(v), \pi_T^{T2}(v)$ and $\pi_T^{PD}(v)$ are the gray-levels possibility distributions of tissue T extracted from T_{T1}, T_{T2} and T_{PD} fuzzy maps respectively and F design the fusion operator, then the fused possibility distribution is defined for any gray level v as :

$$\pi_T(v) = \max\left(\frac{\min(\pi_T^{I_i}(v), \pi_T^{I_j}(v))}{h}, 1-h\right)$$

Where $I_i, I_j \in \{T1, T2, PD\}$, and h is a measure of agreement between $\pi_T^{I_i}$ and $\pi_T^{I_j}$:

$$h = 1 - \sum_{v \in \text{Image}} \left| \pi_T^{I_i}(v) - \pi_T^{I_j}(v) \right| / |\text{Image}|$$

Decision Step

A segmented image was finally obtained using the four maps computed in step 2 by assigning to the tissue T any voxel for which it had the greatest degree of membership.

The general algorithm using for fusion process is :

General algorithm

Modeling of the image

For a in $\{I_i, I_j\}$ **do**

MPFCM (a)

End For

Fusion

Possibilistic fusion

Decision

Segmented image

Three models of fusion are generated by this algorithm : T1/T2 fusion, T1/PD fusion and T2/PD fusion.

Simulated Results

Brainweb provides simulated brain datasets which contains a set of realistic MRIs created using an MRI simulator. In this section, T1-weighted, T2-weighted and PD-weighted brain MR images with a slice thickness of 1 mm, and a volume size of 217x181x181 are employed to investigate the proposed method. These images are obtained from the Brainweb Simulated Brain Database at the McConnell Brain Imaging Centre of the Montreal Neurological Institute(MNI), McGill University.

To compare the performance of these three models of fusion produced by F operator, we compute different coefficients reflecting how well two segmented volumes match. We use a different performance measures :

$$Overlap(Ovrl) = \frac{TP}{TP + FN + FP}$$

$$Similarity(SI) = \frac{2.TP}{2.TP + FN + FP}$$

where TP and FP for true positive and false positive (voxels correctly and incorrectly classified as brain tissue). TN and FN for true negative and false negative, which were defined as the number of voxels correctly and incorrectly classified as non-brain tissue by the automated algorithm. The comparative results are presented in table 1 below :

COMPARATIVE RESULTS

	T1/T2 Fusion			T1/PD Fusion			T2/PD Fusion		
	CSF	WM	GM	CSF	WM	GM	CSF	WM	GM
Overl.	0.88	0.92	0.87	0.85	0.82	0.86	0.77	0.88	0.72
SI	0.96	0.95	0.90	0.90	0.86	0.86	0.81	0.90	0.83

The results in Table 1 show considerable improvement for all tissues using T1/T2 fusion than T1/PD and T2/PD models.

The results obtained on fusion T1/T2 are compared to the results obtained with a fuzzy segmentation computed by the algorithm of classification MPFCM on the T1 image alone, T2 image alone and the PD image alone. An example of segmentation result for the slice 95 of Brainweb is presented in figure 1 below:

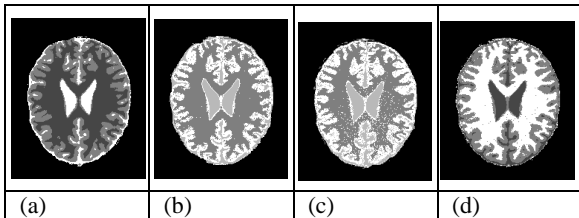

(a) T1 segmented with MPFCM algorithm. (b) T2 segmented with MPFCM algorithm. (c) PD segmented with MPFCM algorithm. (d) Image of T1/T2 fusion with F operator.

The results for each one of the segmentation for all tissues CSF, WM and GM are reported in figures 2 and 3 below :

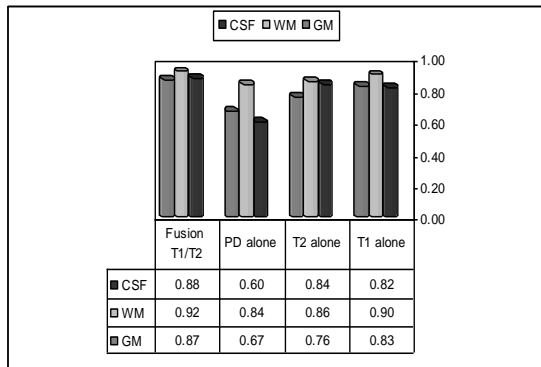

Overlap measurement for different segmentations with 3% noise.

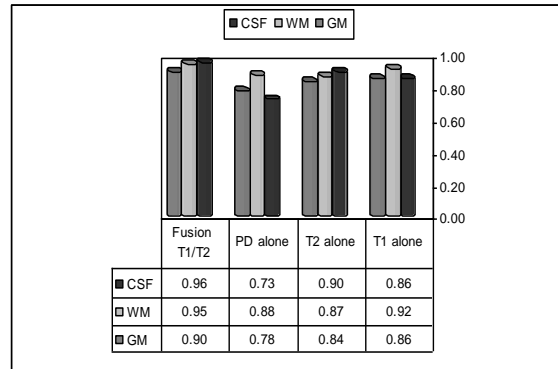

Similarity measurement for different segmentations with 3% noise.

The graphics of figures 2 and 3 underline the advantages of the multispectral fusion images within the fuzzy possibilistic framework to improve the segmentation results clearly. Indeed all measurement values obtained with fusion of T1 and T2 images for CSF, WM and GM tissues are greater than ones obtained when taking into account of only one weighting in MR image segmentation.

Conclusion

In this paper, a study and an evaluation of a novel technique for a brain MRI segmentation based on a fusion approach and possibility theory concepts are discussed. In the proposed method the pixel intensity, its neighborhood, memberships and typicality are used in the modeling step to generate data to fusion step. This method offers a considerable improvement in brain MRI segmentation and demonstrate the superior capabilities of fusion approach compared to the taking into account of only one weighting in MR image segmentation.

As a perspective of this work other more robust algorithms or hybrid algorithms to modeling a data are desired. In addition, we can integrate other numerical, symbolic information, experts' knowledge or images coming from other imaging devices in order to improve the segmentation of the MR images or to detect anomalies in the pathological images.

REFERENCES

- [1] L. P. Clark, R.P. Velthijzen, M. A. Camacho, and J. J. Heine, "MRI Segmentation methods and applications," Magnetic Resonance Imaging, vol. 13, pp. 343–368, 1995.
- [2] I. Bloch, "Some aspects of Dempster-Shafer evidence theory for classification of multi-modality medical images taking partial volume effect into account," Pattern Recognition Letters, vol. 17, pp. 905–919, 1996.
- [3] Y. Hata, S. Kobashi, and S. Hirano, "Automated segmentation of human brain MR images aided by fuzzy information granulation and fuzzy inference", IEEE Trans. SMC, Part C, vol. 30, pp. 381–395, 2000.
- [4] D. Goldberg-Zimring, A. Achiron, and S. Miron, "Automated detection and characterization of multiple sclerosis lesions in brain MR images", Magnetic Resonance Imaging, vol. 16 pp. 311–318,1998.
- [5] K. Van Leemput, F. Maes, D. Vandermeulen, and P. Suetens, "Automated model-based tissue classification of

- MR images of the brain”, IEEE Trans. Medical Imaging, vol. 18, pp. 897–908, 1999.
- [6] Y. Wang, T. Adali, J. Xuan, and Z. Szabo. “Magnetic resonance image analysis by information theoretic criteria and stochastic models”, IEEE Trans, Information Technology in Biomedicine, vol. 5, pp. 150-158, 2001.
- [7] I. Bloch, and H. Maitre, “Data fusion in 2D and 3D image processing: An overview,” X Brazilian symposium on computer graphics and image processing, Brazil, pp. 127–134, 1997.
- [8] W. Dou, S. Ruan, Y. Chen, D. Bloyet, J. M. Constans, “A framwork of fuzzy information fusion for the segmentation of brain tumor tissues on MR images,” Image and vision Computing, vol. 25, pp. 164–171, 2007
- [9] V. Barra and J. Y. Boire, “A General Framework for the Fusion of Anatomical and Functional Medical Images,” NeuroImage, vol. 13, 410–424, 2001.
- [10] D. C. Maria, H. Valdés, J. F. Karen, M. C. Francesca, M. W. Joanna, “New multispectral MRI data fusion technique for white matter lesion segmentation: method and comparison with thresholding in FLAIR images,” Eur Radiol, vol. 20, 1684–1691, 2010.
- [11] E.D Waltz, the principals and practice of image and spatial data fusion in : Davis L, Hall, James Ilinas (Eds), Proceedings of the Eight National Data Fusion Conference ,(Dalls, TX. March 15-17, 1995) Handbook of Multisensor Data Fusion, CRC pess, West Bam Beach, FL,1995, pp. 257–278. (p4–1–4–18).
- [12] F. Behloul, M. Janier, P. Croisille, C. Poirier, A. Boudraa, R. Unterreiner, J. C. Mason, D. Revel, “Automatic assessment of myocardial viability based on PET-MRI data fusion,” Eng. Med. Biol. Mag., Proc. 20th Ann. Int. Conf. IEEE, vol. 1, pp. 492–495, 1998.
- [13] M. Aguilar, R. Joshua, “New fusion of multi-modality volumetric medical imagery,” ISIF, pp. 1206–1212, 2002.
- [14] E. Lefevre, P. Vannoorenberghe, O. Colot, “About the use of Dempster-Shafer theory for color image segmentation,” First international conference on color in graphics and image processing, Saint-Etienne, France, 2000.
- [15] V.Barra, and J-Y Boire, “Automatic segmentation of subcortical brain structures in MR images using information fusion,” IEEE Trans. on Med. Imaging., vol. 20, n7, pp. 549–558, 2001.
- [16] M. C. Clarck, L.O. Hall, D.B. Goldgof, R Velthuizen, F.R. Murtagh, M.S. Silbiger, “Automatic tumor segmentation using knowledge-based techniques,” IEEE Trans. Med. Imaging, vol. 17, pp. 187–201, 1998.
- [17] I. Bloch, “Fusion of numerical and structural image information in medical imaging in the framework of fuzzy sets,” Fuzzy Systems in Medicine, ed. par P. Szczepaniak et al., pp. 429–447, Springer Verlag, 2000.
- [18] I. Bloch, “Information combination operators for data fusion : A Comparative Review with Classification,” IEEE Transactions en systems, Man. and Cybernetics, vol. 1, pp. 52–67, 1996.
- [19] C.Lamiche, A.Moussaoui, “Improvement of brain tissue segmentation using information fusion approach”, International Journal of Advanced Computer Science and Applications, vol 2, n6, pp. 84–90, 2011.
- [20] H. Khotanlou, “3D brain tumors and internal brain structures segmentation in MR images,” Thèse de Doctorat, Ecole Nationale Supérieure des Télécommunications, ParisTech, 2008.
- [21] D. Dubois and H. Prade, “Combination of information in the framwork of possibility theory,” In Data Fusion in Robotics and Machine Intelligence, M. Al Abidi et al., Eds. New York : Academic, 1992.

Quadratic Programming Method to Solve the N-L Optimization Problems Applied to Energy Management System

F. Benhamida

IRECOM laboratory, Department of Electrical Engineering, UDL University, Algeria
farid.benhamida@yahoo.fr

S. Slimane

IRECOM laboratory, Department of Electrical Engineering, UDL University, Algeria
Souag.slimane@gmail.com

A. Gras

Department of Business Sciences, Faculty of economics, UDL University, Algeria
a.graa@gmail.com

A. Bendaoud

IRECOM laboratory, Department of Electrical Engineering, UDL University, Algeria
babelber@gmail.com

Abstract— The subject of optimization applied to the practical real life problems of electrical energy management system is a complex mixture of modeling, mathematical formulation, algorithmic solution processes and in the end the application of the optimal result to the process, where the process, which should be optimized, must be analyzed and must be understood in great depth. In addition complex mathematical equations and algorithms can be involved; also, computer know-how and software engineering capabilities must be present. In the end, the optimal result must be applied to the process. In this paper text we will give a combination of standard mathematical optimization problem formulations together with a straightforward solution procedures based on a quadratic programming algorithm to solve economic dispatch problem as example of energy management system .

Keywords-component; Optimization, Algorithms, linear programming, Quadratic programming, energy management system .

1. Introduction

In the widest sense of the word, optimization is the process of choosing rationally among given alternatives. Most real-world optimization problems (OP) are far too complex or stochastic to be analyzed or solved using mathematics. There are, however, important problems for which one can give a mathematical description, which is both tractable, that is, can be "solved" in some sense, and is a good enough approximation of the problem one really wants to solve. Some typical examples are problems of scheduling (machines, aircraft carriers, trains), dimensioning (of pipes, power plants, inventory size), routing (salesmen, wire, telephone calls), mixing (animal feed, petroleum, products), and construction (bridges, airplanes, integrated circuits) [1]-[5].

As an area of mathematics, optimization is the theory of minimizing or maximizing a function, over some feasible set [1] [6]. Depending on the properties of the involved function and sets, the field of optimization is divided into several sub fields. Du

ring the Second World War, researchers tried to formulate and analyze various mathematical models for transportation of goods, production planning and allocation of scarce resources. This was the birth of operations research. Since then the theory and application of operations research has been rapidly developing. The main quantitative tools of operations research are mathematical programming and simulation [7] [8]. In mathematical programming one is mainly concerned with theory and algorithms for optimization in finite-dimensional spaces. A good survey over the different topics in mathematical programming is given in [9], and for some history see [10].

Mathematical optimization

A system defined in terms of m equations and n unknown variables can be divided into three fundamental types of problems:

1. If $m = n$ the problem is an *algebraic* problem and usually has at least one solution.
2. If $m > n$ the problem is *over constrained* and cannot be solved in general.
3. If $m < n$ the problem is *under constrained* and many solutions can exist that satisfy the system requirements.

The third category of OP is the one discussed in this paper.

Variables in the context of optimization represent the individual elements that uniquely define the OP being considered. The variables can be divided into several categories:

1. Known variables: These variables have usually fixed numerical values. They cannot be solved for because they are known beforehand. Mathematically these variables can be seen as constant numerical values or as parameters.
2. Unknown variables: These are the interesting variables; the goal is to find a set of numeric values for these unknown variables such that optimality is

achieved. Within the set of unknown variables two main subcategories can be found:

Control variables: These unknown variables represent individual elements which can be directly controlled within the process to be optimized.

State variables: These unknown variables cannot be controlled directly within the process to be optimized. Their value is a consequence of the control variables choice and how the process reacts to these control variables values.

Thus an OP consists of different types of variables and usually an under constrained equation system. At this point nothing has been said about the term 'best' or 'improving' the current solution.

Obviously the term “goal” or “objective” of a process must be defined. One wants to minimize or maximize some objective. The objective is defined as a function of variables. In order to compare the optimality of the many solutions of the under constrained system, the objective function allows to give a merit to each solution.

Mathematical formulation and optimality conditions [2]

The general OP formulation is summarized as follows with:

- n = number of variables;
- m = number of equality constraints (linear or nonlinear)
- p = number of inequality constraints (linear or nonlinear)

min $F(x)$
 Subject to

$$g_i(x) = 0, \text{ for } i = 1, \dots, m$$

$$h_i(x) \leq 0, \text{ for } i = 1, \dots, p$$

(1)

The problem is to determine the set of values of the vector (x) for which all equality constraints $g(x) = 0$ and all inequality constraints $h(x) = 0$ are satisfied and for which the objective function is at a strict local optimum.

The OP of Eq. (1) need to be looked at with regard to the following points in order to facilitate a solution to yield the necessary optimality conditions [10]. The points are:

- Make a clear distinction between those inequality constraints, which are “active” (i.e. binding at their limit values) and those, which are “inactive”, i.e., which have a negative functional value in the optimum (satisfied).
- Treat all “active” inequality in the same way as regular equality constraints and determine the optimality conditions for this “pseudo”-equality

constrained problem in the same way as for “standard” equality constrained OP.

- In addition, state that all Lagrange-multipliers (μ_i) of all “active” inequality constraints must be positive.
- Also, state that all “inactive” inequality constraints must have a value less than zero (otherwise they would not be “inactive”).

We can set up the Lagrangian expression considering all equality and all “active” inequality constraints as follows:

$$\min L = F(x) + \sum_{i=1}^m \lambda_i g_i(x) + \sum_{j=1}^{p'} \mu_j h_j(x)$$

$$= F(x) + \lambda^T g(x) + \mu^T h(x)$$

(2)

Where λ_i and μ_i are the Lagrange-multipliers. We assume that the first p' inequality constraints are “active” inequality constraints. All the other inequality constraints are “inactive”. The optimality conditions for this problem are as follows:

$$\frac{\partial L}{\partial x} = \frac{\partial}{\partial x} (F(x) + \lambda^T g(x) + \mu^T h(x)) = 0$$

$$\frac{\partial L}{\partial \lambda} = g(x) = 0$$

$$\frac{\partial L}{\partial \mu} = h(x) = 0, \mu \geq 0$$

(3)

- $h_j(x) = 0, \forall j$: "active" inequality constraint
- $h_i(x) < 0, \forall i$: "inactive" inequality constraint

These points represent the set of necessary optimality conditions for the general non-linear OP of Eq. (1).

Quadratic Programming (QP)

Quadratic Programming is a branch of mathematics that deals with finding extreme values of quadratic functions when the variables are constrained by linear equalities and inequalities [5] [3].

The classic objective function of a QP problem is as follows:

$$\min F = \frac{1}{2} x^T Q x + c^T x$$

(4)

subject to linearized equality and inequality constraints:

$$A_1 x - b_1 = 0$$

$$A_2 x - b_2 \leq 0$$

(5)

Where, x is the vector of unknowns, $\dim(x) = n$; c is the vector of cost coefficients, $\dim(c) = n$; Q is an $(n \cdot n)$ matrix; A_1 is an $(m \cdot n)$ matrix; A_2 is an $(p \cdot n)$ matrix; b_1 is the vector specifying the right hand sides of the equality constraints, $\dim(b_1) = m$; b_2 is

the vector specifying the right hand sides of the inequality constraints, $\dim(b_2)=p$.

All these matrices and vectors except x are numerically given. In addition, the matrix Q must be positive definite and symmetric. (Q is positive definite if and only if $y^T Q y > 0$ for all nonzero vectors y). With these conditions for Q the QP describes a convex problem. Note that depending on the OP, the above matrices can be either sparse or compact (i.e. non-sparse/full).

Linear Programming (LP)

Linear programming is a branch of mathematics that deals with finding extreme values of linear functions when the variables are constrained by linear equalities and inequalities [5] [2] [7].

The standard linear programming problem is defined as

$$\min F = c^T x \tag{6}$$

Subject to:

$$\begin{aligned} A_1 x &= b_1 \\ A_2 x &\leq b_2 \\ x &\geq 0 \end{aligned} \tag{7}$$

where x is the vector of unknowns, $\dim [x]=n$; c is the vector of cost coefficients, $\dim (c)=n$; A_1 is an $(m.n)$ matrix, $m < n$.

A_2 is an $(p.n)$ matrix ; b_1 is the vector specifying the right hand sides of the equality constraints, $\dim (b_1)=m$; b_2 is the vector specifying the right hand sides of the inequality constraints, $\dim (b_2)=p$.

Classification of optimization algorithms to solve general NL-OP

In this section the general OP is solved by an integrated method. All equations and the objective function consist of smooth, twice differentiable parts. The variables x are continuous, real variables. The goal is to find a solution to this general non-linear OP. The nonlinear optimization problem algorithms will be discussed in two classes:

Class-A: Iterative solution of an approximated LP or QP - OP

The class-A algorithms are the Methods whereby the optimization starts from a solved Newton-Raphson (NR) process of a well-determined non-linear system of equations [2]. The Jacobian and other sensitivity relations are used in the optimization process, which is usually LP or QP based. The process as a whole is iterative. After each LP or QP iteration the NR is solved again.

Successive QP solution of approximated OP

An approximation around a given operating point x^0 leads to the following QP system: A quadratically approximated objective function:

$$\min F = \frac{1}{2} \Delta x^T Q \Delta x + c^T \Delta x \tag{9}$$

subject to linearized equality and inequality constraints:

$$\begin{aligned} A_1 \Delta x - b_1 &= 0 \\ A_2 \Delta x - b_2 &\leq 0 \end{aligned} \tag{10}$$

where x is the vector of unknowns, $\dim(x) = n$.

$c = \left(\frac{\partial F}{\partial x} \right) \Big|_{x=x^0}$ is the vector of linearized objective function cost coefficients, $\dim (c) = n$.

$Q = \left(\frac{\partial^2 F}{\partial x^2} \right) \Big|_{x^0}$ is an $(n.n)$ matrix

$A_1 = \left(\frac{\partial g(x)}{\partial x} \right) \Big|_{x=x^0}$ is an $(m.n)$ matrix

$A_2 = \left(\frac{\partial h(x)}{\partial x} \right) \Big|_{x=x^0}$ is an $(p.n)$ matrix

$b_1 = -g(x^0)$ is the vector specifying the right hand sides of the equality constraints, $\dim (b_1)=m$

$b_2 = -h(x^0)$ is the vector specifying the right hand sides of the inequality constraints, $\dim (b_2)=p$

The iteration loop is exemplified in Fig. 1.

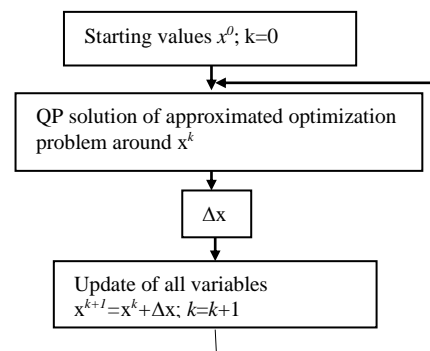

Figure 1. Flow chart of successive QP

Successive QP solution of approximated OP with NR support

The main problem with the iterative procedure of the previous subsection is the choice of the initial

solution point x_0 which affect the convergence. The general goal is to have a solution point x_0 which satisfies the set of equality constraints: $g(x_0) = 0$, but not necessarily the inequality constraints. The problem dimensions have been given before, i.e. $\dim(g) = m$, $\dim(x) = n$. In addition we assume that $m < n$, i.e. there are fewer equality constraints than variables. Thus a degree of freedom exists for the solution of the equality constraint. The trick is now to split the vector x into two subvectors which allow the solution of a set of equations with the same number of non-linear equations and unknown variables. i.e. the equality constraints can be written as follows: $x^T = [x_1^T, x_2^T]$ and $g(x_1, x_2) = 0$, where $\dim(x_1) = m$, $\dim(x_2) = n-m$.

So the previously discussed form of an iterative QP execution can be extended to an iterative execution of first a NR solution process then a QP algorithm, then a variable update or Δx , then starting a new NR algorithm with the new computed values for x_2 , then doing again a QP, etc. This iterative procedure is also not much more than a successive execution of a QP, however the QP starts always around a solved set of non-linear equations, see Fig. 2.

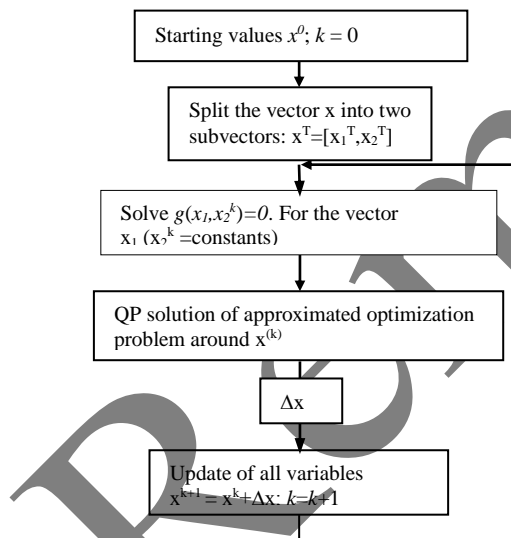

Figure 2. Flow chart of successive QP with NR support

Successive compact QP solution of approximated OP with NR support

The smaller variable and equality constraint number leads to the term “compact” QP. To get this formulation we eliminate the variables Δx from Eq. (10). Conceptually the equality constraints in Eq. (10) are split as follows:

$$A_{11}\Delta x_1 + A_{12}\Delta x_2 - b_1 = 0 \tag{11}$$

From Eq. (11) Δx_1 can be computed as follows:

$$\Delta x_1 = (A_{11})^{-1}(-A_{12}\Delta x_2 + b_1) \tag{12}$$

Note that the matrix A_{11} must be a square (m.m) matrix and it must be non-singular. Then, Eq. (12) exists. This solution for the vector Δx can be substituted in the original QP formulation of Eq. (9) and Eq. (10), giving the following compact QP:

$$\min F = \frac{1}{2} \Delta x_2^T Q' \Delta x_2 + c'^T \Delta x_2 \tag{13}$$

Subject to linearized inequality constraints:

$$A'_{22} \Delta x_2 - b'_2 \leq 0 \tag{14}$$

with

$$Q' = \begin{bmatrix} -A_{12}^T (A_{11}^{-1})^T, U \end{bmatrix} \begin{bmatrix} Q_{11} & Q_{12} \\ Q_{21} & Q_{22} \end{bmatrix} \begin{bmatrix} -A_{11}^{-1} A_{12} \\ U \text{ (unity Matrix)} \end{bmatrix}$$

$$c_2'^T = c_2^T - c_1^T A_{11}^{-1} A_{12}; A'_{22} = A_{22} - A_{21} A_{11}^{-1} A_{12}; b'_2 = b_2 - A_{21} A_{11}^{-1} b_1 \tag{15}$$

Note that the QP defined by Eq. (13) and Eq. (14) is a compact QP with $n-m$ number of variables Δx_2 and no equality constraints. All equality constraints have been eliminated. The output of this compact QP is $\Delta \hat{x}_2$. Once this vector is obtained one can compute the optimal values for $\Delta \hat{x}_1$ by using Eq. (12). This leads to a new iterative algorithm, shown in Fig. 3.

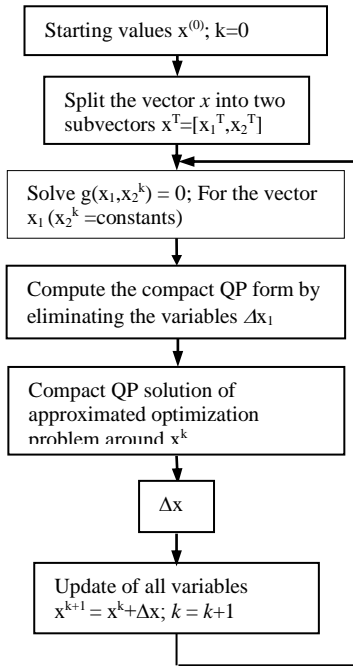

Figure 3. Flow chart of compact QP algorithm.

Class B optimization: Integrated iterative solution of (Kuhn-Tucker) KT-optimality conditions

The class-B relying on the exact optimality conditions whereby the equality constraints are attached. There is no prior knowledge of the solution of any (sub-) set of equality constraints as done in class-A. The process is iterative and each intermediate solution approaches the optimality conditions.

In this section the optimization formulation is solved by an integrated method as compared to the optimization formulation of the class-A where a set of equations and their solution by a NR is separated from the optimization part [2] [7]. In this work one approach is discussed. It is the so-called non-linear Interior Point (IP) approach [35] which is based on an efficient solution of the non-linear (Kuhn-Tucker) KT optimality conditions using a combination of NR, step-length control and barrier function parameter decrease during all iterations. Other algorithms are found in the literature in this class-B optimization. All class-B algorithms have in common that an iterative solution of possibly transformed non-linear KT optimality conditions will be achieved.

Solution of the KT by Interior Point algorithm (KT optimality conditions)

For the solution of KT optimality conditions [6] [4] [8], the problem is defined as follows:

$$L = F(x) + \lambda^T g(x) + \mu^T h(x) \tag{16}$$

Note that only variables x are used in the class-B approach. This is slightly different from the class-A approach where a distinction between the control and state variables is advantageous. The optimality conditions can be derived by formulating the Lagrange function: L
The first order necessary optimality conditions are as follows:

$$\begin{aligned} \frac{\partial L}{\partial x} &= \frac{\partial F(x)}{\partial x} + \left(\frac{\partial g(x)}{\partial x} \right)^T \lambda + \left(\frac{\partial h(x)}{\partial x} \right)^T \mu = 0 \\ \frac{\partial L}{\partial \lambda} &= g(x) = 0 \\ \text{diag} \{ \mu_i \} \cdot \frac{\partial L}{\partial \mu} &= \text{diag} \{ \mu_i \} \cdot h(x) = 0 \\ \frac{\partial L}{\partial \mu} &= h(x) \leq 0, \mu \geq 0 \end{aligned} \tag{17}$$

The third constraint set together with the last set indicates that an inequality constraint is only active (i.e. being limited) when $\mu_i > 0$, i.e. $h_i(x) = 0$. For the case where the inequality i is not active at its limit, $h_i(x) < 0$, $\mu_i = 0$.

Interior Point (IP) optimization

The idea of the NR for equality constraints is extended to include also the inequality constraints in the formulation. In order to understand the key points of the IP algorithm for a NL-OP [6] [4] [8], we must state the following: The original OP is reformulated as follows [3]:

$$\begin{aligned} \min F(x) - \zeta \sum_{i=1}^p \ln(z_i) \quad (\zeta > 0) \\ \text{Subject to } g(x) = 0; h(x) + z = 0; z > 0 \end{aligned} \tag{18}$$

With the following points taken into consideration:

- The positive barrier parameter ζ has to become almost 0.
- We have to force the variables z to remain positive during all iterations of the algorithm. This fact gives the algorithm the name “Interior”. The term barrier has its justification in that the “barrier function” cannot cross the border at zero.

We can formulate now the KT conditions of this new OP assuming implicitly that $z > 0$:

$$L_{IP} = F(x) - \zeta \sum_{i=1}^p \ln(z_i) + \lambda^T g(x) + \mu^T (h(x) + z) \tag{19}$$

From this special IP-oriented Lagrangian we derive the KT-conditions:

$$\begin{aligned} \frac{\partial L_{IP}}{\partial x} &= \frac{\partial F(x)}{\partial x} + \left(\frac{\partial g(x)}{\partial x} \right)^T \lambda + \left(\frac{\partial h(x)}{\partial x} \right)^T \mu = 0 \\ \frac{\partial L_{IP}}{\partial \lambda} &= g(x) = 0 \\ \frac{\partial L_{IP}}{\partial z} &= \mu - \zeta \cdot \text{diag} \left(\frac{1}{z_i} \right) \cdot e = 0 \\ \frac{\partial L_{IP}}{\partial \mu} &= h(x) + z = 0, \mu \geq 0, z > 0 \end{aligned} \quad (20)$$

Eq. (20) represents IP-KT first order conditions which must be valid at the optimum for any given barrier parameter $\zeta > 0$. The vector e in Eq. (20) indicates a vector with 1's only, $\dim(e) = \dim(\mu) = \dim(z) = p$. The principal idea behind the IP solution algorithm of Eq. (20) is as follows:

- Formulate a NR solution step for the equality constraints only. Note, that the number of equality constraints and the number of unknown variables are identical ($n + m + 2p$).
- Choose a starting point for the unknown variables in such a way that all variables, which are limited, get a positive value (i.e. $z^0 > 0, \mu^0 > 0$). The choice for the starting values is quite sensitive for a convergence success of the algorithm.
- After computing the optimal solution $\Delta x_{opt}, \Delta \lambda_{opt}, \Delta z_{opt}, \Delta \mu_{opt}$, of the linear system of one update step with the NR solution procedure, use a step-length control [11] in such a way that all variables z and μ remain positive during all iterations of this iterative algorithm. This is done as follows:
- Obviously the barrier parameter ξ must be very near to zero at the optimum. If this is not the case the OP is not the same as originally formulated.

descriptions of some Energy Management System optimization functions

Economic Dispatch (ED): This function optimizes the total cost of active power generation, assuming that every generator has a convex cost curve related to its own active power, every generator has upper and lower active power generating limits and it is also assumed that the sum of all active powers of generator must be equal to a given total system load plus total system losses.

Optimal Power Flow (OPF): is an optimization function, which minimizes the total generation cost, the total resistive network or the resistive branch losses for a certain area of the network. At the same time the OPF considers all power flow equations and also operational constraints on the network elements like transmission line current limits and voltage magnitude limits on generator nodes. The OPF has

similar goals like the ED, however, it considers the network much more comprehensively than ED.

ED Solution by Quadratic Programming

Generation allocation is defined as the process of allocating generation levels to the thermal generating units in service within the power system, so that the system load is supplied entirely and most economically [12] and [13]. The objective of the generation allocation or ED problem is to calculate, for a single period of time, the output power of every generating unit so that all demands are satisfied at minimum cost, while satisfying different technical constraints of the network and the generators. The standard ED problem can be described mathematically as an objective with two constraints as:

$$\min F_T = \sum_{i=1}^N F_i(P_i) \quad (21)$$

Subject to the following constraints:

$$\sum_{i=1}^N P_i = D + P_{loss}; \text{ and } P_i^{\min} \leq P_i \leq P_i^{\max} \quad (22)$$

where, N is the total number of units in service; P_i is the real power output of i -th generator (MW); F_T is the total operating cost (\$/h); $F_i(P_i)$ is the operating cost of unit i (\$/h); D is the total demand (MW); L is the transmission losses (MW); P_i^{\min}, P_i^{\max} are the operating power limits of unit i (MW).

The fuel cost function of a generator that usually used in power system operation and control problem is represented with a second-order polynomial.

$$F_i(P_i) = c_i + b_i P_i + a_i P_i^2 \quad (23)$$

where, c_i, b_i and a_i are the cost coefficients (non-negative constants) of the i th generating unit.

We propose the following MATLAB code:

```
x=quadprog(H,f,A,b,Aeq,beq,lb,ub)
% solves the the quadratic programming
problem:
min 0.5*x'*H*x + f'*x
% while satisfying the constraints
A*x <= b
Aeq*x = beq
lb <= x <= ub
```

To map the ED to QP, the objective function variables are given by the power generation output vector as follow:

$$x = [P_1, P_2, \dots, P_N]^T \quad (24)$$

$$H = 2 \times \begin{bmatrix} \frac{a_1}{1-2B_{11}P_1 - B_{01}} & \dots & 0 \\ \vdots & \ddots & \vdots \\ 0 & \dots & \frac{a_N}{1-2B_{NN}P_{NN} - B_{0N}} \end{bmatrix}^T$$

(25)

$$f = \left[\frac{b_1}{1-2B_{11}P_1 - B_{01}}, \dots, \frac{b_N}{1-2B_{NN}P_{NN} - B_{0N}} \right]^T$$

(26)

To satisfy the equality constraint $Aeq \cdot x = beq$, we set:

$$Aeq = [1, 1, \dots, 1] + [P_1, P_2, \dots, P_N] \begin{bmatrix} B_{11} & \dots & B_{1N} \\ \vdots & \ddots & \vdots \\ B_{N1} & \dots & B_{NN} \end{bmatrix} + [B_{01}, \dots, B_{0N}] + \left[\frac{B_{00}}{P_1}, \frac{B_{00}}{P_2}, \dots, \frac{B_{00}}{P_N} \right]$$

(27)

$$beq = D + 2P_{loss}$$

(28)

Where P_{loss} is power transmission losses calculated by following loss formula commonly known as the B-coefficients formula:

$$P_{loss} = [P_1, P_2, \dots, P_N] \begin{bmatrix} B_{11} & \dots & B_{1N} \\ \vdots & \ddots & \vdots \\ B_{N1} & \dots & B_{NN} \end{bmatrix} \begin{bmatrix} P_1 \\ P_2 \\ \vdots \\ P_N \end{bmatrix} + \dots + \dots \begin{bmatrix} B_{01} \\ \vdots \\ B_{0N} \end{bmatrix} \begin{bmatrix} P_1 \\ P_2 \\ \vdots \\ P_N \end{bmatrix} + B_{00}$$

(26)

where, B_{ij} , B_{0i} and B_{00} are the loss formula coefficient.

The operating power limits are imposed in the formulation of quadratic programming as follows:

$$lb = [P_1^{\min}, P_2^{\min}, \dots, P_N^{\min}]; ub = [P_1^{\max}, P_2^{\max}, \dots, P_N^{\max}]$$

(27)

To map the ED to QP in MATLAB, we propose the following:

```
for i=1:10
    P1=P'*B*P+B01*P+B00;
    Aeq
    =ones(1,n)+(P'*B+B01+B00/P);
    beq=Pd+2*P1;
    l1=diag(1-2*B*P-B01');
    A1=inv(l1)*a;
    f=inv(l1)*b;
    H=2*diag(A1);
    P=quadprog(H,f,[],[],Aeq,beq,l,u);
```

```
p1n=P'*B*P+B01*P+B00;
acu=(Pd+p1n)-sum(P);
end
```

Case Study And Results

The IEEE 30 bus system has 6 generating units with the characteristics shown in Table I. The line losses are calculated by the B-coefficients method and given in Table II. The network topology and the test data for the IEEE 30 bus system are given in [14].

TABLE I THE 6 THERMAL GENERATORS CHARACTERISTICS OF CASE STUDY 1

Unit N°	P_{imin}	P_{imax}	a_i	b_i	c_i
1	100	500	0.007	7	240
2	50	200	0.0095	10	200
3	80	300	0.009	8	220
4	50	150	0.009	11	200
5	50	200	0.008	10.5	220
6	50	120	0.0075	12	190

TABLE II B- COEFFICIENTS OF IEEE 30-BUS 6-UNIT SYSTEM

$B = 10^{-4}$	2.231	1.162	-0.122	-0.017	0.113	0.39
	1.162	1.89	-0.077	-0.048	0.069	0.28
	-0.122	-0.077	2.004	-0.74	-0.724	-0.599
	-0.017	-0.048	-0.74	-1.479	0.538	0.342
	0.113	0.069	-0.724	0.538	1.185	0.053
	0.39	0.28	-0.599	0.342	0.053	2.34
$B_0 = 10^{-5}$	0.38	1.79	-5.32	1.52	2.33	1.26
$B_{00} = 0.00154$						

We have compared the developed algorithm to other economic dispatch algorithm, Table III show the comparison between QP algorithm and λ iteration algorithm [11] for 8 Times intervals.

TABLE III THE TOTAL COST OF 8 TIME PERIOD FOR THE STUDIED CASE

Hour (h)	Load (MW)	Total Cost with QP (\$/h)	Total Cost with λ iteration (\$/h)	saving (\$/h)
1	955	11797.8396	11839.803	41.963
4	930	11464.9621	11505.290	40.327
7	989	12253.9174	12298.848	44.930
10	1150	14478.1677	14538.501	60.333
13	1190	15049.3433	15117.104	67.760
16	1250	15946.8412	16025.133	78.291
19	1159	14605.7259	14667.566	61.840
22	984	12186.569	12231.043	44.473

The results of the economic dispatch for the 6-units test system are listed in Table III, and it show the performance of the proposed QP method with a valuable (\$/h) saving comparing to λ iteration method. The execution time of the adapted QP algorithm for economic dispatch is faster than the

lambda method where the computational time is about 0.2 second on a Pentium IV, 3 GHz.

Conclusion

Optimization methods are judged by their performance with respect to speed, versatility and robustness. Class-A and class-B methods have their relative merits and perform well for one or the other particular application. In both class-A and class-B algorithms the size of the linear inequality constraint set is identical and thus a distinction between both methods does not exist with respect to this point. Class-B methods are also attractive. They solve all objective function problems with no particular differences during the solution process which is a strong benefit for the class-B methods. This comes mainly from the fact that the class-B algorithms solve the optimality conditions of the original OP directly, where as the class-A algorithms solve only optimality conditions of the approximated OP. In the end the decision may be made based on the best combination of algorithmic robustness, computer code efficiency and computer code maintainability [2][8].

This paper presents a QP formulation for ED taking into consideration the generation limits, transmission losses. The demand is assumed to be periodic. We applied the QP approach to the periodic implementation of the optimal solutions of ED problem problems. The convergence and robustness of the QP algorithms are demonstrated through the application of QP to a 6-unit IEEE test system.

The results showed that the differences in Total cost results between the QP approach and λ iteration method are satisfactory, which checks the validity of this study.

References

- [1] The Help document of Optimization Toolbox, included in MATLAB 6.0 help, Mathwork, <http://www.mathwork.com>, html, 2003.
- [2] R. Bacher, Optimization of Linearized Electric Power Systems, <http://www.eus.ee.ethz.ch/people/bacher.html>, 2002.
- [3] W.D. Rosehart, Optimization of Power Systems with Voltage Security Constraints, Thesis of PHD, Waterloo University, 2000.
- [4] V. H. Quintana, G. L. Torres, and J. M. Palomo, "Interior-Point Methods and Their Applications to Power Systems: A Classification of Publications and Software Codes," IEEE Trans. on Power Systems, Vol. 15, No. 1, September 2000; pp. 170-176.
- [5] W. Cheney, D. Kincaid, Numerical Mathematics and computing, New York, Brooks/Cole Publishing Company, 1999.
- [6] A. Garzillo, M. Innorta and M. Ricci, "The flexibility of interior point based optimal power flow algorithms facing critical network situations", Electrical power and Energy Systems, Vol. 21, 1999, pp. 579-584.
- [7] R. Bacher, "The Optimal Power Flow (OPF) and its solution by the Interior Point Approach", The Swiss Federal Institute of Technology Zurich Report, Dec 1997.
- [8] B. Jansen I, C. Roos, T. Terlaky and J.-Ph. Vial, "Interior-point Methodology for Linear Programming: duality, sensitivity analysis an computational aspects". Report 93-28

of Faculty of Technical Mathematics and Informatics, Delft, The Netherlands, 1993.

- [9] G. L. Nemhauser, A. H. G. R. Kan and M. J. Todd, eds., "Optimization, Handbooks in operations research and management science", vol. 1, North-Holland, 1989.
- [10] J. K. Lenstra, A. H. G. Rinnooy Kan and A. Schrijver, eds. "History of mathematical programming", North-Holland, 1991.
- [11] F. Benhamida, "A Short-term unit commitment solution using Lagrangian relaxation method", Doctorat Thesis, Electrical Engineering Department, Alexandria University, Décembre 2006.
- [12] F. Benhamida et al, "Generation allocation problem using a hopfield-bisection approach including transmission losses," Elect. Power and Energ. Syst., vol. 33, no. 5, pp. 1165-1171, 2011.
- [13] F. Benhamida, A. Bendaoud, K. Medles, and A. Tilmatine, "Dynamic economic dispatch solution with practical constraints using a recurrent neural network", Przegląd Elektrotechniczny (Electrical Review), R. 87 NR 8, pp. 149-153, 2011.

<http://www.ee.washington.edu/research/pstca>.

New Algorithm to Solve Convex Separable Programming

¹A.Chikhaoui, ²B. Djebbar, ³A. Mokhtari, ³A.Belabbaci

¹University of Tiaret Algeria, ²University of USTO Oran Algeria, ³University of Laghouat Algeria,
 ah_chikhaoui@yahoo.fr, badj2000@yahoo.fr, kek_mokhtari@yahoo.fr, A_Belabbaci@yahoo.fr.

Abstract: Separable programming is very useful for solving problems of nonlinear programming. In this paper we propose a new algorithm for solving problems of nonlinear programming separable. We approximate the nonlinear problem by a polynomial of degree two, we use a quadratic programming algorithm to find the optimal solution.

Keyword: global optimization, piecewise quadratic function, separable programming.

Introduction

SEPARABLE PROGRAMMING is a special class of nonlinearly constrained optimization problems whose objective and constraint functions are sums of functions of one variable. Separable programming problems are usually solved by linear programming techniques (Hillier and Lieberman, 2001). A separable programming (SP) problem whose objective and constraint functions are sums of functions of one variable (Gill et al., 1981). The SP problem can be solved efficiently by linear optimization techniques. The flow interaction among wells can play an important role in some rate allocation problems. In such cases, the rate allocation problem is formulated as a general nonlinear constrained optimization problem and solved by a Sequential Quadratic Programming method (Gill et al., 2002). Separable linear programming is a method for solving nonlinear problems by using the simplex algorithm employed in linear programming.

Its use in agricultural economics is illustrated by the Blakley and Kloth study of plant location and the Holland and Baritelle study of school location. However, a shortcoming of separable linear programming is the risk of not obtaining a global optimum solution. Neither of the above studies reported information on the likelihood of having obtained non-global solutions. While this problem is reasonably well documented in literature on quantitative methods, it is examined and illustrated in the following discussion to help assure the proper use of separable programming in applied research.

Problem statement

Let's consider the general nonlinear programming problem:

$$(P_f) = \begin{cases} \text{Minimize } f(x) \\ g_i(x) \leq b_i \\ i = 1, \dots, m \end{cases}$$

with two additional provisions: 1) the objective function and all constraints are separable, and 2) each decision variable x_j is bounded below by 0 and above by a known constant u_j , $j = 1, \dots, n$.

Recall that a function, $f(x)$, is separable if it can be expressed as the sum of function of the individual decision variables.

$$f(x) = \sum_{j=1}^n f_j(x_j)$$

The separable nonlinear programming problem has the following structure.

$$f(x) = \sum_{j=1}^n f_j(x_j)$$

$$\text{subject to } \sum_{j=1}^n g_{ij}(x_j) \leq b_i, \quad i = 1, \dots, m$$

$$0 \leq x_j \leq u_j, \quad j = 1, \dots, n$$

The key advantage of this formulation is that the nonlinearities are mathematically independent. This property in conjunction with the finite bounds on the decision variable permits the development of a piecewise quadratic approximation for each function in the problem.

Consider the general nonlinear function $f_j(x)$ defined on the interval $[a, b]$; and let $a = x_1, \dots, x_n = b$ a subdivision of $[a, b]$ with step $h = x_{i+1} - x_i$, n odd.

On every interval $[x_i, x_{i+2}]$, we replace the function f_j with a polynomial of two degree.

Notations

Let $(x_i)_{i=1,2,\dots,n_1}$ subdivision of $[a_1, b_1]$, n_1 odd,

x_{n_1}			
-----------	--	--	--

$$x_1 = a_1$$

$$x_2 = a_1 + h_1$$

⋮

$$x_{n_1} = a_1 + n_1 h_1 \quad \text{where} \quad h_1 = \frac{b_1 - a_1}{n_1}$$

and let $(x_{n_1+i})_{i=1,2,\dots,n_2}$ subdivision of $[a_2, b_2]$,

n_2 odd,

$$x_{n_1+1} = a_2$$

$$x_{n_1+2} = a_2 + h_1$$

⋮

$$x_{n_1+n_2} = a_2 + n_2 h_2 \quad \text{where} \quad h_2 = \frac{b_2 - a_2}{n_2}$$

For $x_1 \leq x \leq x_3$, put $x = x_1 + t_1 h_1$, where

$$t_1 \in [0, 2], \text{ or } t_1 = \frac{x - x_1}{h_1}.$$

Generally for

$$x_{2i-1} \leq x \leq x_{2i+1}, \quad t_i = \frac{x - x_{2i-1}}{h_1},$$

$$1 \leq i \leq \frac{n_1 - 1}{2}.$$

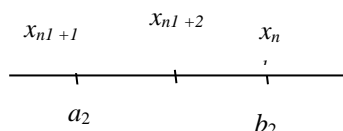

Interpolation of the function...

Set $f(y_1, y_2) = \varphi_1(y_1) - \varphi_2(y_2)$ with $a_1 \leq y_1 \leq b_1, a_2 \leq y_2 \leq b_2$

a) Interpolation of the function φ_1 .

If $x_1 \leq x \leq x_3$, the function φ_1 is replaced by the Newton polynomial of degree two noted :

$$P_2(x) = \varphi_1(x_1) + \frac{t_1}{1!} \Delta \varphi_1(x_1) + \frac{t_1(t_1-1)}{2!} \Delta^2 \varphi_1(x_1),$$

the polynomial can be calculated from the following finite differences table.

x	$\varphi_1(x)$	$\Delta \varphi_1(x)$	$\Delta^2 \varphi_1(x)$
x_1			
x_2			
⋮			

With $t_1 = \frac{x - x_1}{h_1}$, set then

$$\psi_1(t_1) = P_2(x) - \varphi_1(x_1) = \alpha_1 t_1 + \beta_1 t_1^2$$

where $\alpha_1 = \Delta \varphi_1(x_1) - \frac{1}{2} \Delta^2 \varphi_1(x_1)$ and

$$\beta_1 = \frac{1}{2} \Delta^2 \varphi_1(x_1)$$

In general, for $x_{2i-1} \leq x \leq x_{2i+1}$,

$$P_2(x) = \varphi_1(x_{2i-1}) + \frac{t_i}{1!} \Delta \varphi_1(x_{2i-1}) + \frac{t_i(t_i-1)}{2!} \Delta^2 \varphi_1(x_{2i-1})$$

With $t_i = \frac{x - x_i}{h_1}$, put then

$$\psi_i(t_i) = P_2(x) - \varphi_1(x_{2i-1}) = \alpha_i t_i + \beta_i t_i^2$$

$$i = 1, 2, \dots, \frac{n_1 - 1}{2}.$$

The study of the optimum of the function ψ defined by

$$\psi\left(t_1, t_2, \dots, t_{\frac{n_1-1}{2}}\right) = \sum_{i=1}^{\frac{n_1-1}{2}} \psi_i(t_i) \quad \text{replace}$$

then the study of the optimum of the function φ_1 on the interval $[a_1, b_1]$. We add the supplementary condition: **one and one only t_i is positive.**

In fact, the linear constraints are written $0 \leq t_i \leq 2$, furthermore, if $t_{i_0} \in]0, 2[$

and $t_i = 0$ for all

$$i = 1, 2, \dots, \frac{n-1}{2}, \quad i \neq i_0 \text{ then}$$

$$\psi\left(t_1, t_2, \dots, t_{\frac{n_1-1}{2}}\right) = \alpha_{i_0} t_{i_0} + \beta_{i_0} t_{i_0}^2 = \psi_{i_0}(t_{i_0}),$$

$$= P_2(x) - \varphi_1(x_{2i_0-1})$$

Consequently

$$P_2(x) = \psi\left(t_1, t_2, \dots, t_{\frac{n_1-1}{2}}\right) + \varphi_1(x_{2i_0-1}); \quad \text{and we}$$

see that the optimum of P_2 is that of ψ

b) **Interpolation of the function φ_2 :**

In the same manner as in part a) and for $a_2 \leq x \leq b_2$, we set $y_2 = x$, $\Delta^n \varphi_2(x_{n_1+2i-1}) = \Delta(\Delta^{n-1} \varphi_2(x_{n_1+2i-1}))$; if

$x_{n_1+1} \leq x \leq x_{n_1+3}$, the function φ_2 is replaced by the Newton polynomial of degree two noted :

$$P_2(x) = \varphi_2(x_{n_1+1}) + \frac{t_{\frac{n_1-1}{2}+1}}{1!} \Delta \varphi_2(x_{n_1+1}) + \frac{\left(t_{\frac{n_1-1}{2}+1}\right)\left(t_{\frac{n_1-1}{2}} - 1\right)}{2!} \Delta^2 \varphi_2(x_{n_1+1})$$

the polynomial can be calculated from the finite differences table.

With $t_{\frac{n_1+1}{2}} = \frac{x - x_{n_1+1}}{h_2}$, we set

$$\psi_2\left(t_{\frac{n_1+1}{2}}\right) = P_2(x) - \varphi_2(x_{n_1+1})$$

where

$$\alpha_{\frac{n_1+1}{2}} = \Delta \varphi_2(x_{n_1+1}) - \frac{1}{2} \Delta^2 \varphi_2(x_{n_1+1}) \text{ and}$$

$$\beta_{\frac{n_1+1}{2}} = \frac{1}{2} \Delta^2 \varphi_2(x_{n_1+1})$$

Generally, for $x_{n_1+2i-1} \leq x \leq x_{n_1+2i+1}$,

$$P_2(x) = \varphi_2(x_{n_1+2i-1}) + \frac{t_{\frac{n_1-1}{2}+i}}{1!} \Delta \varphi_2(x_{n_1+2i-1}) + \frac{t_{\frac{n_1-1}{2}+i}\left(t_{\frac{n_1-1}{2}+i} - 1\right)}{2!} \Delta^2 \varphi_2(x_{n_1+2i-1})$$

With $t_{\frac{n_1-1}{2}+i} = \frac{x - x_{n_1+2i-1}}{h_2}$, put then

$$\psi_i\left(t_{\frac{n_1-1}{2}+i}\right) = P_2(x) - \varphi_2(x_{n_1+2i-1})$$

$$= \alpha_{\frac{n_1-1}{2}+i} t_{\frac{n_1-1}{2}+i} + \beta_{\frac{n_1-1}{2}+i} t_{\frac{n_1-1}{2}+i}^2$$

where

$$\alpha_{\frac{n_1-1}{2}+i} = \Delta \varphi_2(x_{n_1+2i-1}) - \frac{1}{2} \Delta^2 \varphi_2(x_{n_1+2i-1})$$

$$\beta_{\frac{n_1-1}{2}+i} = \frac{1}{2} \Delta^2 \varphi_2(x_{n_1+2i-1}) \text{ and}$$

$$i = 1, 2, \dots, \frac{n_2-1}{2}$$

The study of the optimum of the function ψ_2 defined by

$$\psi_2\left(t_{\frac{n_1-1}{2}+1}, t_{\frac{n_1-1}{2}+2}, \dots, t_{\frac{n_1-1}{2}+\frac{n_2-1}{2}}\right) = \sum_{i=1}^{\frac{n_2-1}{2}} \psi_i\left(t_{\frac{n_1-1}{2}+i}\right)$$

replace then the study of the optimum of the function φ_2 on the interval $[a_2, b_2]$.

Add the supplementary condition :

one and one only $t_{\frac{n_1-1}{2}+i}$ is positive.

In fact, the linear constraints are written

$$0 \leq t_{\frac{n_1-1}{2}+i} \leq 2. \text{ Furthermore, if } t_{i_0} \in]0, 2[$$

and $t_{\frac{n_1-1}{2}+i} = 0$ for all $i = 1, 2, \dots, \frac{n_2-1}{2}, i \neq i_0$

then:

$$\psi_2\left(t_{\frac{n_1-1}{2}+1}, t_{\frac{n_1-1}{2}+2}, \dots, t_{\frac{n_1-1}{2}+\frac{n_2-1}{2}}\right) = \alpha_{i_0} t_{i_0} + \beta_{i_0} t_{i_0}^2 = \psi_{i_0}(t_{i_0}) = P_2(x) - \varphi_2(x_{n_1+2i_0-1})$$

Consequently

$$P_2(x) = \psi_2\left(t_{\frac{n_1-1}{2}+1}, t_{\frac{n_1-1}{2}+2}, \dots, t_{\frac{n_1-1}{2}+\frac{n_2-1}{2}}\right) + \varphi_2(x_{n_1+2i_0-1})$$

And we see that the optimum of P_2 is that of ψ_2

When the objective function is not quadratic, replace then problem (P) with the problem (P') deduce from (P) as following :

replace the function φ_1 by ψ_1

and replace the function φ_2 by ψ_2

i.e.

$$(P') \begin{cases} \psi\left(t_1, t_2, \dots, t_{n_1}, \dots, t_{\frac{n_1-1}{2}+\frac{n_2-1}{2}}\right) = \sum_{i=1}^{\frac{n_1+n_2-1}{2}} \alpha_i t_i + \beta_i t_i^2 \\ 0 \leq t_i \leq 2 ; 1 \leq i < \frac{n_1-1}{2} + \frac{n_2-1}{2} \\ \text{is at most one } t_i \text{ is nonzero in each} \\ \text{of the choosed subdivision.} \end{cases}$$

The calculus of y_i is given by the formulas :

$$y_1 = x_{2i-1} + h_1 t_i \text{ if } 1 \leq i \leq \frac{n_1-1}{2}$$

$$y_2 = x_{n_1+2i-1} + h_2 t_{n_1+i} \text{ if } 1 \leq i \leq \frac{n_2-1}{2}$$

Algorithm:

Solving **separable programming problem** into two parts:

- 1.expression each function,
- 2.approximation interval and step,
- 3.approximat each function by the method of finite differences
4. With this approximation, we construct the quadratic program for each function
- 5.solve quadratic program associated to each function. We obtain value of component x_j^* and the approximate value of the function $f_j(x_j^*)$.
6. Go to 1.

Algorithm separable :

Data : number_variable_separable,
 number_constrainte_separable,
 Matrix_A_constraintes, vector_b

// input of express functions and bororne inf, borne sup, step.

```

For j=1: number_variable_separable
    Txt= input(' expression of the jeme function');
    Express_fun(j,1:length(txt))=txt;
    Txt_param = input( 'lower bound,upper bound, step');
    param_fun(j,1:3)=eval(['[' txt_param ']']);
end
    
```

// quadratic interpolation of functions

```

for k=1:n_variables_sep
    x=linspace(param_fun(k,1),param_fun(k,2),param_fun(k,3));
    y=eval(express_fun(k,:));
    x_values(k,1:length(x))=x;
    func_values(k,1:(length(y)))=y;
    D1=diff(y) ; D2=diff(D1) ;
    ndif2=length(D2); ne=(ndif2+1)/2 ;
    alpha_f(k,1:ne+1)=[ ne D1(1:2:ndif2)-0.5*D2(1:2:ndif2) ] ;
    beta_f(k,1:ne+1)=[ne 0.5*D2(1:2:ndif2) ] ;
end
    
```

// solve quadratic programming problems

```

for indice_func = 1:n_variables_sep
    algorithm_qp(alpha_f, beta_f);
end
Results = x_optimale_value, f_optimal_value.
    
```

algorithm_qp(α , β)

Begin Algorithm Initialization: vectors α , β , b and matrix A , δ Z $Z=Z_0$, $A_positif = true$;

While ($A_positif = true$) do

For all indexes j :

$$\text{Calculate } \theta_j = \min_i \left\{ \frac{b_i}{a_{ij}}, a_{ij} > 0 \right\},$$

For all indexes j : Calculate $\Delta_j = \alpha_j \theta_j + \beta_j \theta_j$.

Choose $\Delta_{j_0} = \max_j \Delta_j$.

if $\Delta_{j_0} = +\infty$ then STOP : this program don't have optimum.

if $\Delta_{j_0} \leq 0$ then STOP : this program is optimal.

Let $z = z + \Delta_{j_0}$, x_{j_0} is entering basic vector.

$$\theta_0 = \min_i \left\{ \frac{b_i}{a_{ij_0}}, a_{ij_0} > 0 \right\}, x_{i_0} \text{ is leaving basic}$$

vector. $a_{i_0 j_0}$ is the pivot.

For all indexes j : if $j \neq j_0$ then

$$\alpha'_j = \alpha_j - \left(\alpha_j + 2\beta_j \theta \right) \frac{a_{i_0 j}}{a_{i_0 j_0}} + \frac{b_{i_0}}{a_{i_0 j_0}} \left(\delta_{j_0 j} + \delta_{j j_0} \right)$$

;

else $\alpha'_{j_0} = 0$; $\beta'_{j_0} = 0$ endif

For all indexes i For all indexes j

if ($i \neq i_0$)

$$a'_{ij} = a_{ij} - \frac{a_{ij}}{a_{i_0 j_0}} a_{i_0 j} ; b'_i = b_i - \frac{a_{i_0 i}}{a_{i_0 j_0}} b_{i_0}.$$

endif endfor endfor.

$A_positif = false$;

For all indexes i For all indexes j :

if $a_{ij} > 0$ then $A_positif = true$

endif endfor endfor

if $A_positif = false$

this program do not have optimum Stop.

endif

endWhile.

Example Let the function $f_j(x) = x - \text{Log } x$,

defined on $\left[\frac{1}{2}, \frac{5}{2} \right]$, to maximize. We use the two

degree polynomial of Newton with step $h = 0.5$ to interpolate.

x	0.5	1	1.5	2	2.5
$y = f_j(x)$	1.19	1	1.09	1.31	1.58

Calculate $\psi_1(t_1)$.

x	y	Δy	$\Delta^2 y$
0.5	1.19	-0.19	0.28
1	1	0.09	
1.5	1.09		

To use the polynomial of Newton, we find:

$\alpha_1 = -0.33 \quad \beta_1 = 0.14$ and

$\psi_1(t_1) = -0.33t_1 + 0.14t_1^2$.

1. Calculate $\psi_2(t_2)$.

x	y	Δy	$\Delta^2 y$
1.5	1.09	0.22	0.05
2	1.31	0.27	
2.5	1.58		

$\alpha_2 = -0.20 \quad \beta_2 = 0.03$ and

$\psi_2(t_2) = 0.20t_2 + 0.03t_2^2$.

Consequently

$\psi(t) = -0.33t_1 + 0.20t_2 + 0.14t_1^2 + 0.03t_2^2$ that we maximize.

We use the method describe in [10] to resolve this problem. Recall the expression of θ and Δ (see [9]).

$$\theta_j = \min_{a_{kj}} \left\{ \frac{b_k}{a_{kj}}, \text{ for the } a_{kj} > 0 \right\} \text{ and}$$

$$\Delta_j = \alpha_j \theta_j + \beta_j \theta_j^2$$

t_1	t_2	
-0.33	0.20	α
0.14	0.03	β
2	2	θ
-0.10	0.52	Δ
1	0	$t_3 = 2$
0	1	$t_4 = 2$

t_2 is entering variable and it replaces t_4 in the base.

More, $t_2 = 2$ and $t_1 = 0$.

The maximum of the function $\psi(t) = -0.33t_1 + 0.20t_2 + 0.14t_1^2 + 0.03t_2^2$ is given by $t_2 = 0$ and $t_1 = 0$.

The optimum of this function equal 0.5.

The maximum of the objective function is the in the point $x = x_3 + 2h$ i.e. in the point with abscise $x = 2.5$, this maximum is equal 1.58.

The maximum of $P_2(x)$ is equal $0.52 + f_j(x_3) = 1.61$ who is near the real value of this maximum.

Note that is important to find only the value of t_j for which the function $\psi(t) = -0.33t_1 + 0.20t_2 + 0.14t_1^2 + 0.03t_2^2$ is optimal.

We say that the objective function is optimal in the point $x = x_{2j-1} + t_j h$.

The maximum of the objective function is calculating immediately.

Results and discussion

- It is possible to solve large nonlinear separable problems with the quadratic separable programming,
- We used an approximation of order two which is more accurate than the first order approximation used in the linear approximation to apply simplex procedure.
- It is possible to approximate constraints by similar procedure.
- To get more accurate result, the piecewise quadratic approximation fi can be refined.

REFERENCES

[1] Blakley, Leo. V. and Donald W. Kloth, "Price Alignment and Movements of Class 1 Milk Between Markets", *American Journal of Agricultural Economics*, 54(1972): 496-502.

[2] Chikhaoui A, Djebbar B., Bellabacci A, Mokhtari A., 2009. Optimization of a quadratic function under its Canonical form *Asian Journal of Applied Sciences* 2(6):499-510

[3] Chikhaoui A, Djebbar B., and Mekki R., 2010. New Method for Finding an Optimal Solution to Quadratic Programming Problem, *Journal of Applied Sciences* 10(15):1627- 1631-2010. ISSN 1812-5654.

[4] Chikhaoui A, Djebbar B., Bellabacci A, Mokhtari A.,2011. An Algorithm for calculating optimal Solution of Quadratic Programming problems. Not published yet.

[5] Stephen B. and Lieven V., 2004. Convex Optimization, *Cambridge University Press*.

[6] HILLIER, F.S., AND LIEBERMAN, G.J., 2001. *Introduction to Operations Research, 7th Edition*, McGraw-Hill Companies, Inc., New York, NY,

[7] Holland, David W. and John L. Baritelle, "School Consolidation in Sparsely Populated Rural Areas: A Separable Programming Approach", *American Journal of Agricultural Economics*, 57(1975): 567-575.

[8] GILL, P.E., MURRAY, W., AND SAUNDERS, M.A., 2002. "SNOPT: An SQP Algorithm for Large-scale Constrained Optimization", *SIAM J. Optimization*, Vol. 19, No. 4, pp. 979-1006.

[9] PADBERG, M., 2000. "Approximating Separable Nonlinear Functions Via Mixed Zero-One Programs", *Operations Research Letters*, 27 (200), 1-5. S., 1984, *Programmation linéaire*. Traduction française. Edition MIR. Moscou.

Evaluation of the Dynamic Reliability by Differential Equations

Wahiba MASSOUM¹

Myriam NOUREDDINE²

University of Sciences and Technology of Oran, Algeria
Computer Science department, Faculty of science, USTO Oran, Algeria

[1massoum-wahiba@hotmail.fr](mailto:massoum-wahiba@hotmail.fr) [2myriam.nouredine@univ-usto.dz](mailto:myriam.nouredine@univ-usto.dz)

Abstract: Dynamic reliability is defined as the part of the probabilistic analysis in dependability, which studies in an integrated manner the behavior of human-machine systems-software affected by a change in the underlying dynamics. In this article, we study the evaluation of the dynamic reliability of a test case, the heated tank. Our approach consists of four steps: the first one is to study the system in a functional analysis using the FAST method, the second step allows studying the tank through a dysfunctional analysis to obtain dangerous events which can lead to the failure system; the third step is used to model the system by a tree of events in the context of dependability and the last step is to model the different paths leading to failure and the final result is a mathematical model in the form of differential equations.

Keywords: Dependability, reliability dynamic, functional analysis, FAST method, event tree, differential equations.

I. INTRODUCTION

Dependability [1] allows maintaining the proper functioning of a system or a product throughout its life cycle. Factors of dependability, reliability plays an important role because it measures the ability of a system to remain without failure. On the other hand, the dynamic reliability is defined as the part of the probabilistic analysis in dependability, which studies in an integrated manner the behavior of systems affected by changing underlying dynamics. Thus, it is necessary to use applied mathematics, such as probability theory and the field of differential equations for the modeling of complex systems.

This article is organized as follows. The second section presents our approach to assessing the reliability dynamics following four steps. The application of the approach to the test case heated tank is presented in

the third section and the end result is the mathematical model in the form of differential equations.

II. DESCRIPTION OF THE APPROACH

There are several methods for evaluating the dynamic reliability however, at present the problems of dynamic reliability have not been solved in the general case.

A study of different methods developed to assess the dynamic reliability, we found that the method of PDMP (piecewise Deterministic Markov Processes) [2], [3] is the most widely used because it can naturally take into account events the deterministic evolution of the physical parameters of the stochastic processes and events corresponding to the random demand or failures of system components. To do this, to help meet the challenges posed by the dynamic reliability, we propose an approach integrating PDMP to define the different trajectories of a system and then calculate the probability of failure for each event using the dreaded differential equations.

A. Flowchart of the proposed approach:

We give here a flowchart (Figure 1) shows the different steps of the methodology, followed by a description of each step:

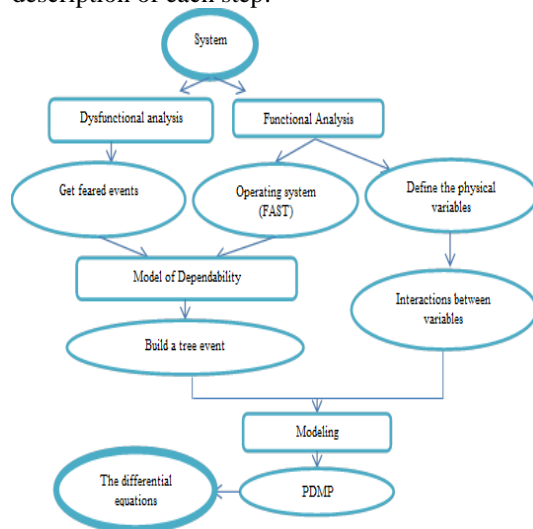

Figure 1: Flowchart of the proposed approach
 B. Description of the different steps:

1) Step 1: Functional Analysis

The Functional Analysis [4] applies to the creation or improvement of a system. We use Functional decomposition following FAST(Function Analysis System Technique) [5]. This technique allows to highlight the design process by showing the relationship between needs and solutions [3]. To use this method you must answer the following questions (Figure 2): why, when and how?

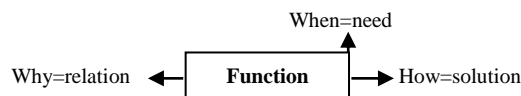

Figure 2: Implementation of FAST

At the level of functional analysis, we define:

- The physical variables: This step identifies the physical variables that describe the system from the functional decomposition.
- The interactions between variables: As we are in the context of dynamic reliability, one must study the interactions between these different physical variables as dynamic reliability takes into account these interactions.

2) Step2: Dysfunctional Analysis

Dysfunctional Analysis [6] is to imagine all the failures that can occur anywhere in the system. It is realized through three phases can be represented by the following figure:

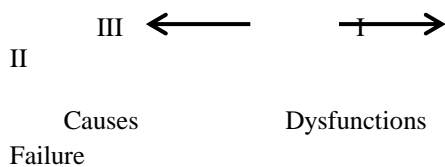

Figure3: The phases of the Dysfunctional Analysis

From Dysfunctional Analysis, we define the set of undesirable events that can lead to failure.

3) Step 3: Model of Dependability

In the context of dependability, we adopt the method of event trees which embodies a simple and natural [7] and reveals the consequences caused by different events, from an initiating event.

The approach generally [7] chosen to perform an analysis by event tree is as follows: define the initiating event to consider, identify the security functions provided to cope, build and operate tree and describe sequences events identified..

4) Step 4: Modelling of the system by PDMP

The PDMP [2], [3] are stochastic hybrid dynamical models, defining deterministic trajectories punctuated by random jumps.

A PDMP is determined by a hybrid process noted: $X(t) = (x_t, m_t)$:

- A discrete variable m_t present mode or process state at time t.
- A state variable Euclidean $x_t \in \mathbb{R}^d$.

The PDMP is determined by its local characteristics $(E_m, \Phi_m, \lambda_m, Q_m)$ $m \in M$

a. E_m a subspace open in \mathbb{R}^n :

Let M be a countable set whose elements are called profiles, for all $m \in M$, let E_m is a subset opened in \mathbb{R}^n . Let $E = \bigcup_{m \in M} E_m \times \{m\}$

b. The flow Φ : defines the deterministic trajectory between two jumps.

c. The intensity of jumps λ_m :

$\bar{E} \rightarrow \mathbb{R}^+$ is a measurable function characterizing the frequency jumps, and which satisfies:

$$\forall (x, m) \in E, \exists \epsilon > 0 \text{ tel que } \int_0^\epsilon \lambda_m(\Phi_m(x, s)) ds < \infty.$$

d. The measurement of transition of the process

$Q_m :$
 $Q_m : \bar{E} \times \mathcal{B}(\bar{E}) \rightarrow [0, 1]$ checks for any couple (x, m)
 $\in \bar{E} : Q_m(x, E - \{(x, m)\}) = 1$

That is to say that the process should jump to a new mode and / or a new position

III. CASE STUDY

We will apply our approach on a test case of heated tank which is an example of literature is representative of the gas and petroleum industry.

A. Principle of System Operation[1] :

The tank(Figure 4) contains the liquid whose level is measured by three sensors each connected to a unit. Unit 1 and 2 are used to add liquid in the vessel and unit 3 of obtaining. It has 4 positions for each unit: O (Open), F (Closed), Ob (Open blocked) and Fb (Closed blocked).

The height of the liquid height h varies between 4 m and 10 m and the temperature θ is between 0 ° C and 100 ° C.

The tank is characterized by two jumps: Jumping random caused to drive failure and Jumping deterministic caused to control laws:

- The first control law is L1 when the liquid level is less than 6 meters. Units if they are not locked, position themselves in the mode $m = (O, O, F)$ to fill the tank.

- The second control law L2 occurs when the level exceeds 8 m: units are placed in the mode $m = (F, F, O)$ to remove excess liquid.

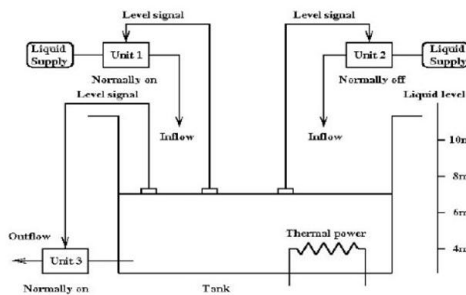

Figure4:Schema of thermal tank

B. Application on the heated tank:

The proposed approach follows four sequential steps described above:

1) Step 1: Functional Analysis

To study the functioning of the system and to identify its physical variables we need a functional decomposition.

➤ Functional decomposition following FAST:

Following the methodology of the FAST approach, we obtained the following diagram (Figure 5) representing the functional decomposition of the tank.

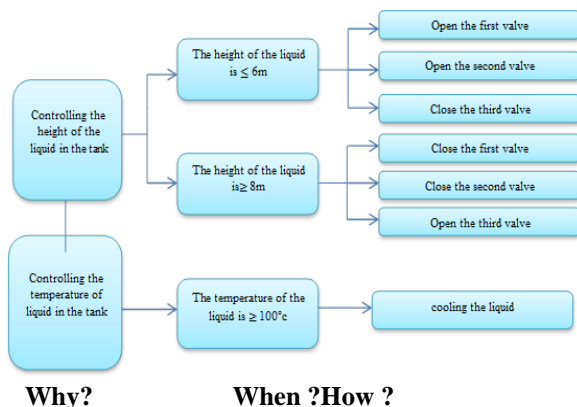

Figure5: Functional decomposition following FAST

➤ The physical variables:

According to the functional decomposition there are three physical variables: height, temperature and mode of the system is the state of the component.

➤ The interactions between variables:

There are three types of interactions between these variables.

- **Interaction temperature-mode:** The transition from one mode to another in the event of a drive failure depends on the evolution of the temperature.

- **Interaction height-mode:** The control laws L1 and L2, by a change in system mode, can change the trajectory of the pitch when it goes beyond 6m or 8m. So there is interaction between the height and the mode.

- **Interaction height-temperature:** The height and temperature are continuous variables that evolve over time. More precisely, the height is independent, but the temperature depends on the height.

2) Step 2: Analysis Dysfunctional:

To apply the Dysfunctional Analysis, we identify three phases we have seen previously:

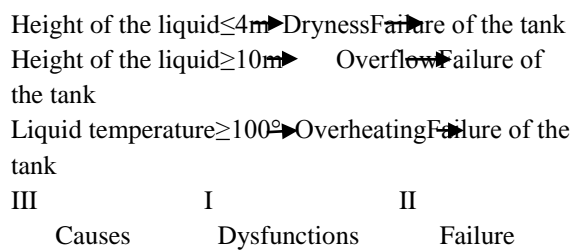

From the analysis we get 3 Dysfunctional feared events are: Dryness, Overflow and Overheating.

3) Step 3: Model of Dependability: To build the tree of events, it is necessary to identify the set of all combinations generated from the possible states.

➤ The different modes of tank:

As we saw previously each unit of the tank has 4 possible states: open, open blocked, closed and closed blocked. The tank has 64 possible modes [2].

➤ Different jumps of 4 states:

Each hop of the four states (Figure 6) are defined by [2]:

- An open state can only go to an open state blocked or closed blocked.
- A closed state can only go to an open state blocked or closed blocked.

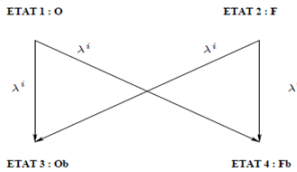

Figure 6 : Different jumps of 4 states

➤ Construction of treeevents:

As in [2], we sought before constructing the tree event to simplify the system by reducing, if possible modes of tank starting from the initial condition $m(0) = (O, F, O)$ by eliminating all states not derived from $m(0)$. We obtain 37 modes [2] instead of 64 modes.

The following figure (Figure 7) describes the event tree constructed for the 37 modes obtained.

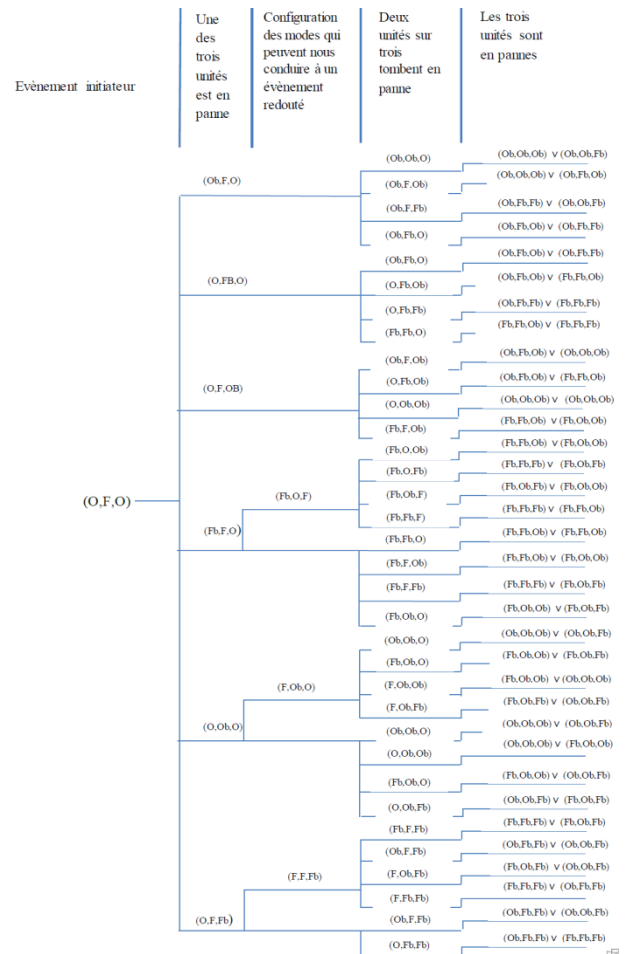

Figure7 :the tree of events obtained for 37 modes

4) Step 4: Modelling of the system by PDMP [2], [3]

➤ Identification of differential equations for the system:

Before identifying the local characteristics of the PDMP we present the system of differential equations [2], [3] following which describes the overall behavior of the tank:

$$(S) = \begin{cases} \frac{dh}{dt} = \gamma_1(\alpha) \\ \frac{d\theta}{dt} = \frac{\gamma_2(\alpha) - \gamma_3(\alpha)\theta}{h} \end{cases}$$

➤ Identification of the characteristics of PDMP:

According to the definition of the PDMP, the following are identified:

a. The state space E :

The height of the liquid must evolve in the interval [6, 8]. Beyond this range, the system reacts, through control laws. It is therefore considered that

the height of 6 m and 8 m are the borders of the state space. The temperature of the liquid must evolve between 0 ° C and 100 ° C. So we can define the state space by the following formula:

$$E = ([4,6] \times [\theta, 100]) \cup ([6,8] \times [\theta, 100]) \cup ([8,10] \times [\theta, 100])$$

b. The flow ϕ :

Height and temperature represent the flow of ϕ PDMP describing the behavior of the tank. Flow associated with mode m is defined by : $\phi(h, \theta, t) = (h(t), \theta(t))$ where h(t) and $\theta(t)$ are the solutions of the differential system (S)

c. The intensity λ_m :

The intensity of jump λ_m for a mode m is the sum of the failure rates $2\lambda^i$ of units, for example from the transition graph obtained for the mode m_1 you can go to m_{15} et m_{27} with intensity λ^1 [as unit 1 fails], to m_4 et m_5 with intensity λ^2 [as unit 2 fails], to m_2 et m_3 with intensity λ^3 [as unit 3 fails].

$$\text{So: } \lambda_1(\theta) = 2(\lambda^1(\theta) + \lambda^2(\theta) + \lambda^3(\theta))$$

d. The measurement of transition Q :

The kernel Q summarizes the probabilities of transition from mode m to another mode m' .

- Jumping with a control law \Leftrightarrow Transition probability = 1
- Jumping to a dreaded event \Leftrightarrow Transition probability = 1/2
- Jumping to another mode after a failure of the unit \Leftrightarrow Transition probability = failure rate / intensity of jump.

➤ Constants of the differential system:

We note α the coefficient $\alpha = (\alpha_1, \alpha_2, \alpha_3)$ defined for every $i=1, 2, 3$ by :

$$\alpha_i = \begin{cases} 0 & \text{if unit } i \text{ is closed or closed blocked} \\ 1 & \text{if unit } i \text{ is open or open blocked} \end{cases}$$

The following table (table1) shows the constants related to the differential system (S).

With $(\gamma_1(\alpha), \gamma_2(\alpha), \gamma_3(\alpha))$ in $m.h^{-1}$, q in $m.h^{-1}$ it presents the flow measuring units θ_{in} in °C It presents the temperature of the liquid supplied by the units 1 and 2. K in $m.^{\circ}C.h^{-1}$ is a parameter related to the physical variables of the tank.

TABLE I
CONSTANTS RELATED TO THE DIFFERENTIAL SYSTEM (S)

$\gamma_1(\alpha)$	$\gamma_2(\alpha)$	$\gamma_3(\alpha)$	q	θ_{in}	K
$(\alpha_1 + \alpha_2 - \alpha_3)q + \alpha_2$	$q\theta_{in} + \alpha_2$	$(\alpha_1 + \alpha_2)q$	1.5	1 5	23.88 915

We set also as constants:

$$\theta_1 = \frac{q\theta_{in} + K}{q} = 30,9261^{\circ}C, \quad \theta_2 = \frac{2q\theta_{in} + K}{2q} = 22,96305^{\circ}C$$

$$\text{So that we have: } \begin{cases} \gamma_2(\alpha) = \theta_1 \sin(\alpha_1 + \alpha_2) = 1 \\ \gamma_3(\alpha) = \theta_2 \sin(\alpha_1 + \alpha_2) = 2 \end{cases}$$

The following table (TABLE II) shows the different configurations depending on the coefficient α :

TABLE III
CONSTANTS RELATED TO THE DIFFERENTIAL SYSTEM (S)

$\alpha = (\alpha_1, \alpha_2, \alpha_3)$	$\gamma_1(\alpha)$	$\gamma_2(\alpha)$	$\gamma_3(\alpha)$	$\frac{\gamma_2}{\gamma_3}$	$\frac{\gamma_2}{\gamma_1}$
$\alpha = (0,1,0)$ et $(1,0,0)$	q	$q\theta_{in} + K$	Q	θ_1	1
$\alpha = (1,1,0)$	2q	$2q\theta_{in} + K$	2q	θ_2	1
$\alpha = (1,1,1)$	q	$2q\theta_{in} + K$	2q	θ_2	2
$\alpha = (0,0,0)$	0	K	0		
$\alpha = (0,1,1)$ et $(1,0,1)$	0	$q\theta_{in} + K$	Q	θ_1	
$\alpha = (0,0,1)$	-q	K	0		0

➤ Résolution des équations différentielles :

Whether $(h(0), \theta(0), m(0))$ the initial conditions of the tank, then the set of solutions of (S) are:

- If $m(0)$ correspondsto the coefficient $\alpha = (0,1,0)$ or $(1,0,0)$ So $\forall t \in R^+$:

$$\begin{cases} h(t) = qt + h(0) \\ \theta(t) = \frac{h(0)(\theta(0) - \theta_1)}{h(t)} + \theta_1 \end{cases}$$

- If $m(0)$ corresponds to the coefficient $\alpha = (1,1,0)$ So $\forall t \in R^+$:

$$\begin{cases} h(t) = 2qt + h(0) \\ \theta(t) = \frac{h(0)(\theta(0) - \theta_2)}{h(t)} + \theta_2 \end{cases}$$

- If $m(0)$ corresponds to the coefficient $\alpha = (1,1,1)$ So $\forall t \in R^+$:

$$\begin{cases} h(t) = qt + h(0) \\ \theta(t) = \frac{h^2(0)(\theta(0) - \theta_2)}{h^2(t)} + \theta_2 \end{cases}$$

- If $m(0)$ corresponds to the coefficient $\alpha = (0,0,0)$ So $\forall t \in R^+$:

$$\begin{cases} h(t) = h(0) \\ \theta(t) = \frac{K}{h(0)}t + \theta(0) \end{cases}$$

- If $m(0)$ correspondsto the coefficient $\alpha = (0,1,1)$ or $(1,0,1)$ So $\forall t \in R^+$:

$$\begin{cases} h(t) = h(0) \\ \theta(t) = (\theta(0) - \theta_1)e^{-\frac{qt}{h(0)}} + \theta_1 \end{cases}$$

- If $m(0)$ correspondsto the coefficient $\alpha = (0,0,1)$ So $\forall t \in R^+$:

$$\begin{cases} h(t) = -qt + h(0) \\ \theta(t) = \theta(0) - \frac{K}{q} \ln\left(\frac{h(t)}{h(0)}\right) h(0) \end{cases}$$

We obtain the following formula:

$$h(t) = \gamma_1(\alpha)t + h(t) \quad \forall t \in R^+$$

IV. CONCLUSIONS

In this article, we presented an approach to evaluate the dynamic reliability of a system.

The approach allows us to study the system considered by Dysfunctional and Functional Analysis in the context of dependability, then modeled by a tree of events to identify the different paths leading to the functioning and to the dysfunctioning set. Given the complexity and limitations of mathematics to evaluate analytically the dynamic reliability of a system, currently dynamic reliability is often accessible only by the PDMP method and in this context, we integrate the PDMP in our approach in order to define the different trajectories of the system and then calculate

the probability of failure for each event using the differential equations.

We applied our approach to the test case, the heated tank, known in the literature. On the method of PDMP applied to this example [2], [3] we introduced upstream the steps of functional and dysfunctional analysis of the tank. We obtained respectively the functional diagram of the tank and the tree of events. The final result is a mathematical model in the form of differential equations, which express the trajectories leading to undesirable events.

The application of our approach on this example has allowed to validating the first two steps and to make the learning of the PDMP method. The continuity of this work is to test the approach on a real system; the final result will be the calculation of the failure probability for each undesirable event, by the model exploitation of the obtained differential equations.

REFERENCES

- C. G.ZWINGELSTEIN, Sûreté de fonctionnement des systèmes industriels complexes. Techniques de l'Ingénieur, S825v2 / S8251, 2009.
- D. K.GONZALEZ, Contribution à l'étude des processus markoviens déterministe par morceaux. Thèse de Doctorat, Ecole Doctorale de Mathématique et Informatique, L'université de Bordeaux, 3 Décembre 2010.
- E. H.ZHANG, F.DUFOUR, F.INNAL, Y.DUTUIT, Fiabilité dynamique et processus déterministe par morceaux. Maîtrise de risques et sûreté de fonctionnement, Congrès Lambda mu 15. Lille, 2006.
- F. P.SEVERIN, Analyse fonctionnelle, de la méthode aux outils. Document pédagogique, Sciences appliquées à l'hôtellerie-restauration, Toulouse (France), 01 Avril 2009.
- G. J.W.BRYANT, Function Analysis Systems Techniques: the basics, Monograph of the SAVE International-The value society, March 1999.
- H. M.LAHLALI, Le management des organismes de formation professionnelle au service du pilotage des systèmes de formation : cas d'expérimentation au Maroc, Thèse de Doctorat de Sciences de gestion, Université de Lyon-2, 12 Novembre 2001.
- Y. MORTUREUX, Arbres de défaillances, des causes et d'évènements. Techniques de l'Ingénieur, SE4050, 2002.

INDEX OF AUTHORS

M. Andriamiarina	01
H.Daoud	01
M.Belarbi	01
D.Méry	01
C.Tanougast	01
A. Hariche	08
M. Belarbi	08
H. Daoud	08
A.Benabbou	14
S. NaitBahloul.....	21
M.Madani.....	21
K. Bekki.....	21
B. Alshaqaqi.....	27
A.Baquhaizel	27
M. Ouis	27
M. Bekhti	32
B.Abdelaziz	32
I. Alshaqaqi	32
L.Chaabane	37
A. Moussaoui	37
F. Benhamida	42
A. Gras	42
S. Slimane	42
A. Bendaoud	42
B. Djebbar	50
A. Mokhtari	50
A. BOURIDANE.....	50
A.Belabbaci	50
W.Massoum.....	56
M.Noureddine.....	56

Call for Paper
First International Workshop on Mathematics and Computer Science
(IWMCS2012)
December 16-17, 2012, Tiaret, Algeria

The University Ibn Khaldoun, Tiaret, Computer Science and mathematical departments are organizing an international Workshop in Computer Science and mathematics from 16 - 17 December 2012. This workshop concerns both the national and international scientific community and will be primarily focusing on mathematical formal methods. Formal methods become mature and can be establish models in different applications for example, Web technologies, Information Systems, Decision Systems, Embedded Systems, Control-command Systems and Real-time Systems. It exists another ways to establish models of systems based also on mathematical concepts and we can, find various domain of application pattern recognition, cryptography , biometrics, The optimization of these kinds of numerical models will be also discussed. Finally we dedicated significant space to mathematics like Partial Differential Equations, polynomial computing. We welcome novel research surrounding the above subjects. Topics of interest include, but not limited to:

- A. Theoretical foundations of models
- B. Formal methods and industrial practice
- C. Automated verification
- D. Numerical Models optimisation
- E. Partial Differential Equations
- F. Polynomial computing
- G. Case studies

Organization comity

President :

Mostefa BELARBI - University of Tiaret- Algeria

Members :

Lahcene GUEDDA	University of Tiaret- Algeria
Abderrahmane LARABI	University of Tiaret- Algeria
Halim BENALI	Universitaire Centre of Relizane – Algérie
Khathir BEKKI	University of Tiaret- Algeria
Samir NESSAN	University of Tiaret- Algeria
Aicha LAKHDARI	University of Tiaret- Algeria
Hayat DAOUD	University of Tiaret- Algeria
Sabrina AMAR	University of Tiaret- Algeria
Rekia ALEM	University of Tiaret- Algeria
Chahrazed ADDA	University of Tiaret- Algeria University of Tiaret- Algeria
Abdelkader CHAIB	Universitaire Centre of Tissemslit – Algérie
Djamel TURKI	University of Tiaret- Algeria
Ahmed BOUZIDANE	University of Tiaret- Algeria
Abdelhamid HARICHE	University of Tiaret- Algeria

Program chair

Abdelkader SENOUCI University of Tiaret- Algeria

Program comity

B.ATMANI	University of Oran – Algeria
M. BELARBI	University of Tiaret- Algeria
B. BELDJILALI	University of Oran – Algeria
F. BENDELLA	University USTO - Algeria
A. H. BENYAMINA	University of Oran – Algeria
A. BESSAID	University of Tlemcen - Algeria
K. BOUAMRANE	University of Oran – Algeria
R. BOUGUENANE	University of Quebec –Chicoutimi, Quebec, Canada
A. BOURIDANE	University of New Castle - United Kingdom
A. CHAIB	University of Tiaret - Algeria
A. CHOUARFIA	University USTO – Oran - Algeria
M. A. CHEIKH	University of Tlemcen - Algeria
M.SNOUCI	University of Oran – Algeria
Y. DAHMANI	University of Tiaret -Algeria
L. DERAFA	EMP Bordj El Behri – Algiers
Z. DIBI	University of Batna- Algeria
M. A. HAMRI	Aix-Marseille University – France
Ali MELIT	University of Jijel – Algeria
D. MERY	Henri Poincaré University- Nancy I - France
P. MILLIGAN	Queen’s University Belfast United Kingdom
M. NABTI	CRD – GN Algiers
O. NOUALI	CERIST - Algiers
M. OULD-CHEIKH	EMP Bordj El Behri – Algiers
P. SAGE	Queen’s University Belfast United Kingdom
M. SENOUSI	University of Oran – Algeria
A. SEGHER	University of Paris VI – France
C. TANOUGAST	Paul Verlaine University of Metz - France
D. TURKI	University de Tiaret - Algeria
E. TRANVOUEZ	Aix-Marseille University – France
M. LAADJEL	CRD – GN Algiers
EI-B. BOURENANE	University- of Bourgogne – France
L. GUEDDA	University of Tiaret- Algeria
A. LARABI	University of Tiaret- Algeria
M. AISSANI	University of Tiaret- AlgeriaUniversity of Tiaret- Algeria
V. BURENKOV	University of Padova – Italy
Tamara TARARYKOVA	University of Cardiff – United Kingdom
M GOLDMAN	University of Moscou – F. Russia
S. SAMKO	University of Aveiro – Portugal
N AIBECHÉ	University of Setif -Algeria
R. KESSI	University USTHB – Algiers
M MORSLI	University of Tizi-Ouzou -Algeria
R. DE FITTE PAUL	University of Rouen - France
B.GLEYSE	INSA of Rouen – France
D. KENDALL	University of newcastle – UK
Y.LEBBAH	University of Oran

Submissions

Papers are invited with interest on the related areas. Each paper should follow the IEEE format with title, author’s names, affiliation, email addresses, an up to 150 words abstract, and a two columns with 6 single spaced pages and with font size at 10 pts. All papers are submitted electronically in PDF format and in English language only and be mailed to iwmcs2012@univ-tiaret.dz

Important dates

Deadline for paper submission: September 30, 2012

Notification of acceptance: November 05, 2012

Deadline of Camera-ready manuscript submission: November 25, 2012-07-06

The journal concerns both computer science and mathematical communities. The journal focuses on models and mathematical analysis. Models were used in different applications for example, Web technologies, Information Systems, Decision Systems, Embedded Systems, Control-command Systems and Real-time Systems. The optimization of these kinds of numerical models can be also discussed. Finally we dedicated significant space to mathematical analysis like Partial Differential Equations, polynomial computing,...

Submissions

Papers are invited with interest on the related areas. Each paper should follow the IEEE format with title, author's names, affiliation, email addresses, an up to 150 words abstract, and a two columns with single spaced pages and with font size at 10 pts. All papers are submitted electronically in PDF format and in English language only and be mailed to momaj@univ-tiaret.dz or momajournal@gmail.com

LIM Laboratory

Computer Science department
College of Sciences, Technology and Materials Sciences
Ibn Khaldoun University of Tiaret - Algeria