



## Validation of a Single-Phase Cascaded Multilevel Inverter based on Newton Raphson

Fayçal CHABNI, Rachid TALEB

Electrical Engineering Department, Hassiba Benbouali University, Chlef, Algeria

Laboratoire Génie Electrique et Energies Renouvelables (LGEER)

chabni.fay@gmail.com, [rac.taleb@yahoo.fr](mailto:rac.taleb@yahoo.fr)

Reçu le : 28/05/2017

Accepté le : 05/09/2017

### Abstract

*This paper presents the application of Selective Harmonic Elimination Pulse Width Modulation (SHEPWM) using the Newton-Raphson (N-R) algorithm to improve the quality of the output voltage waveform generated by a seven level H-bridge cascade inverter with unequal DC sources, the Newton-Raphson algorithm is used to compute the firing angles in such way that allows the elimination of low order harmonics (3<sup>rd</sup> and 5<sup>th</sup>) and also control the output voltage. A small scale prototype of the proposed seven level inverter was built to validate simulation results. The experimental results are in agreement with the simulations.*

**Keywords:** Multilevel inverter; Newton-raphson; harmonics; H-bridge.

### 1. Introduction

In the recent years Multilevel have received a lot of attention for their characteristics. They can withstand a huge amount of voltage stress; they are also very easy to make and to maintain due to their modular structure. The conventional multilevel cascade configuration can be achieved by connecting multiple H-bridge modules in series; this configuration will be briefly covered in this work. The harmonic content in an AC voltage waveform generated by an inverter can affect significantly the performance of AC machines. For example harmonics can raise the temperature of an AC motor which decreases the lifetime of the insulation and consequently the lifetime of the motor itself. One way to fight this problem is by choosing the right modulation strategy.

Several modulation strategies have been proposed and studied for the control of multilevel inverters such as Sinusoidal Pulse width modulation (SPWM) [1] and space vector pulse width modulation

(SVPWM) [2, 3]. A more efficient method called selective harmonic elimination pulse width modulation (SHE-PWM) is also used; the method offers a lot of advantages such as operating the inverters switching devices at a low frequency which extends the lifetime of the switching devices. The main disadvantage of this method is that a set of non-linear equations must be solved to obtain the optimal switching angles to apply this strategy.

The optimal firing (switching) angles are computed by solving a set of non linear equation that represents the desired waveform. Multiple algorithms have been used to solve the optimal switching problem for multilevel inverters such as Genetic Algorithm [4, 5], Differential Evolution [6, 7] and particle swarm optimization [8, 9] but these algorithms are hard to program and they can take a long time to solve the equations. Newton-Raphson algorithm can be used to solve the optimal switching problem, it is really easy to program and it can solve the non linear equations in few seconds.

This study presents the use of N-R based selective harmonic elimination on a seven level inverter composed of two simple H bridge modules. The next section will present briefly the Selective harmonic elimination for multilevel inverters. The third section explains briefly the application of the NR algorithm in the SHEPWM problem and also presents the obtained simulation and experimental results.

## **2. N-R based Selective Harmonic Elimination**

Cascaded Multilevel Inverter topology rely on a simple principle based on the summation of voltages generated by each individual cell (H-bridge) to obtain a staircase output voltage waveform. Fig.1 illustrates the voltage waveform of a seven level inverter. Fig.2 demonstrates the proposed single phase seven level asymmetrical inverter. It is formed by two H-bridges connected in series each bridge is powered by electrically isolated power supplies to generate the desired waveform.

Each H-bridge module is connected to its respective isolated DC source; each module can generate three voltage levels in different patterns,  $+V$  which is the positive voltage of the DC source,  $0V$  and  $-V$  which is the negative voltage of the DC source, and as it can be observed in Fig. 2 in order to obtain seven levels at the output of the inverter, the DC voltage source connected to the lower cell has to be twice the value of the DC source connected to the upper cell ( $V_{dc2} = 2 \times V_{dc1}$ ).

For the staircase output voltage waveform of multilevel inverter as shown in Fig.1 there are 3 voltage levels (in quarter waveform) and 2 undesired harmonics.

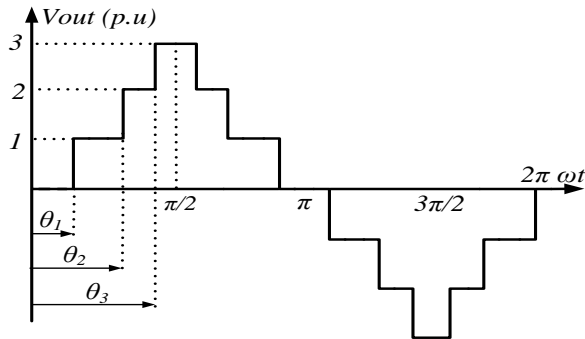

Figure 1: The desired seven level voltage waveform

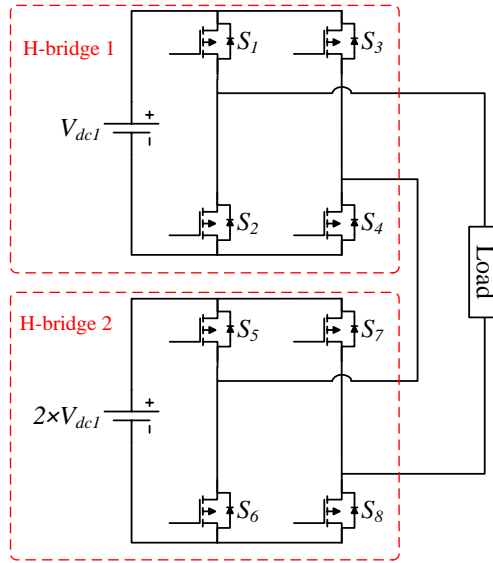

Figure 2: The topology of the proposed seven level inverter

To control the peak value of the output voltage to a desired value and eliminate the 3<sup>rd</sup> and 5<sup>th</sup> harmonic the resulting equations and since the voltage waveform has quarter and half wave symmetry characteristics, the Fourier series expansion is given as:

$$V(\omega t) = \sum_{n=1,3,5,\dots}^{\infty} \left[ \frac{4V_{dc}}{n\pi} \sum_{i=1}^p \cos(n\theta_i) \right] \sin(n\omega t) \quad (1)$$

where  $n$  is rank of harmonics, and  $p = (N-1)/2$  is the number of switching angles per quarter waveform, and  $\theta_i$  is the  $i^{th}$  switching angle, and  $N$  is the number of voltage levels per half waveform. The optimal switching angles  $\theta_1$ ,  $\theta_2$  and  $\theta_3$  can be determined by solving the following system of non-linear equations:

$$\begin{cases} H_1 = \cos(\theta_1) + \cos(\theta_2) + \cos(\theta_3) = M \\ H_3 = \cos(3\theta_1) + \cos(3\theta_2) + \cos(3\theta_3) = 0 \\ H_5 = \cos(5\theta_1) + \cos(5\theta_2) + \cos(5\theta_3) = 0 \end{cases} \quad (2)$$

where  $M = (((N - 1)/2)r/4)$ ,  $r$  is the modulation index.

### 3. Newton-raphson based SHEPWM

The Newton-Raphson (NR) method is one of the most widely used and also one the fastest iterative methods for root-finding. In this study the NR is used to solve the system of transcendental equations expressed in (2) to obtain the optimal switching angles. The system can be written in following form:

$$F(\theta) = B \quad (3)$$

where:

$$F(\theta) = \begin{bmatrix} \cos(\theta_1) & \cos(\theta_2) & \cos(\theta_3) \\ \cos(3\theta_1) & \cos(3\theta_2) & \cos(3\theta_3) \\ \cos(5\theta_1) & \cos(5\theta_2) & \cos(5\theta_3) \end{bmatrix} \quad (4)$$

and

$$B = \begin{bmatrix} rn \\ 0 \\ 0 \end{bmatrix} \quad (5)$$

Which represents the desired amplitudes for the fundamental component, 3<sup>rd</sup> and 5<sup>th</sup> harmonic respectively.

In order to solve this system of equations of any value of  $r$  the following steps must be achieved:

- Guess the initial values of the optimal angles  $\theta^0$  where:

$$\theta^0 = \begin{bmatrix} \theta_1^0 \\ \theta_2^0 \\ \theta_3^0 \end{bmatrix} \quad (6)$$

- Evaluate  $F(\theta)$  and  $B(r)$  using (4) and (5) then compute the Jacobian matrix  $J(\theta)$ , where :

$$J(\theta) = \begin{bmatrix} -\sin(\theta_1) - \sin(\theta_2) - \sin(\theta_3) \\ -3\sin(3\theta_1) - 3\sin(3\theta_2) - 3\sin(3\theta_3) \\ -5\sin(5\theta_1) - 5\sin(5\theta_2) - 5\sin(5\theta_3) \end{bmatrix} \quad (7)$$

- Compute  $d\theta$  using the following relation:

$$d\theta = INV[J(\theta)](B - F) \quad (8)$$

- Update the values of  $\theta$  using the following relation:

$$\theta^{k+1} = \theta^k + d\theta^k \quad (k \text{ is the current iteration}) \quad (9)$$

- Repeat steps 2 (Evaluation) to 4 (update) for a number of iterations ( $k$ ) to reach an acceptable error value  $d\theta$ .

Figure 3 presents the computational process using NR algorithm for different values of  $r$ .

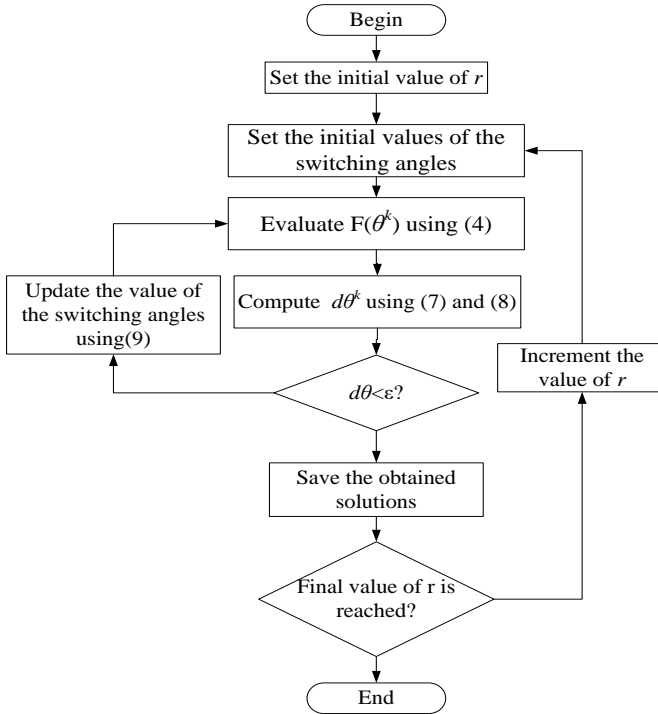

Figure 3: Flowchart of the NR algorithm

To prove the theoretical predictions and to test the effectiveness of the proposed algorithm, the control method and the mathematical model of the proposed inverter were developed and simulated using MATLAB/SIMULINK scientific programming environment. Figures 4 and 5 present the optimal switching angles  $\theta_1$ ,  $\theta_2$  and  $\theta_3$  versus the modulation index  $r$  and the corresponding total harmonic distortion (THD) versus the modulation index  $r$  respectively. The THD was computed using equation (10).

$$THD\% = \frac{\sqrt{\sum_{n=3}^{\infty} H_n^2}}{H_1} \times 100 \quad (10)$$

The value of  $r$  varies from 0 to 1.1 with a step of 0.001 and it can be seen from the figures that the NR algorithm did not find solutions

(switching angles) for every value of  $r$  the generated solutions range from 0.7 to 0.87 and from 1.02 to 1.04.

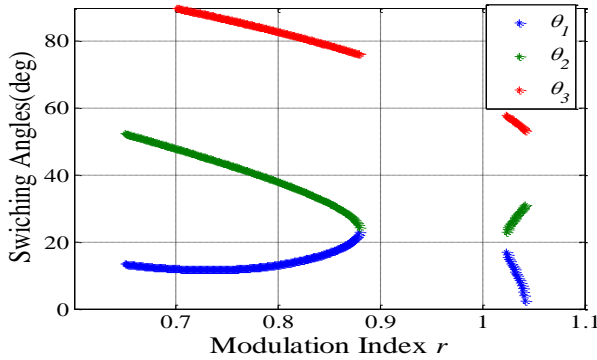

Figure 4: Optimal switching angles versus modulation index  $r$

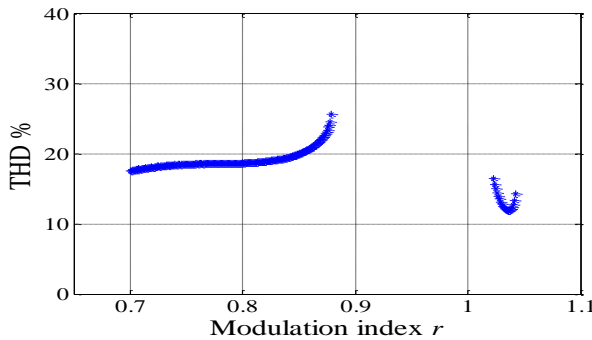

Figure 5: Total harmonic distortion versus modulation index  $r$

Table 1 presents the values (in degrees) of the obtained optimal switching angles for two values of modulation indices  $r = 0.701$  and  $r = 1.036$ , the first value presents the first solution generated by the NR algorithm whereas the second value presents the modulation index with the lowest THD value, corresponding angles for each modulation were used in simulations and experimentally validated to prove the theoretical predictions.

TABLE 1: The obtained optimal switching angles



Modulation index	$\theta_1$	$\theta_2$	$\theta_3$
0.701	11.968	47.829	89.880
1.036	8.466	28.849	54.828

A small scale seven level inverter was built to validate the results obtained from the simulation process; Irf640 MOSFETS were used as switching devices for the proposed inverter. TLP250 optocouplers were used to protect the microcontroller used in this experiment, Siglent SDS 1000 oscilloscope with FFT functionality was used to view analyze the generated waveforms.

Figures 6 and 7 present simulation and experimental results of the generated waveforms with their respective FFT for  $r = 0.701$  and  $r = 1.036$  respectively.

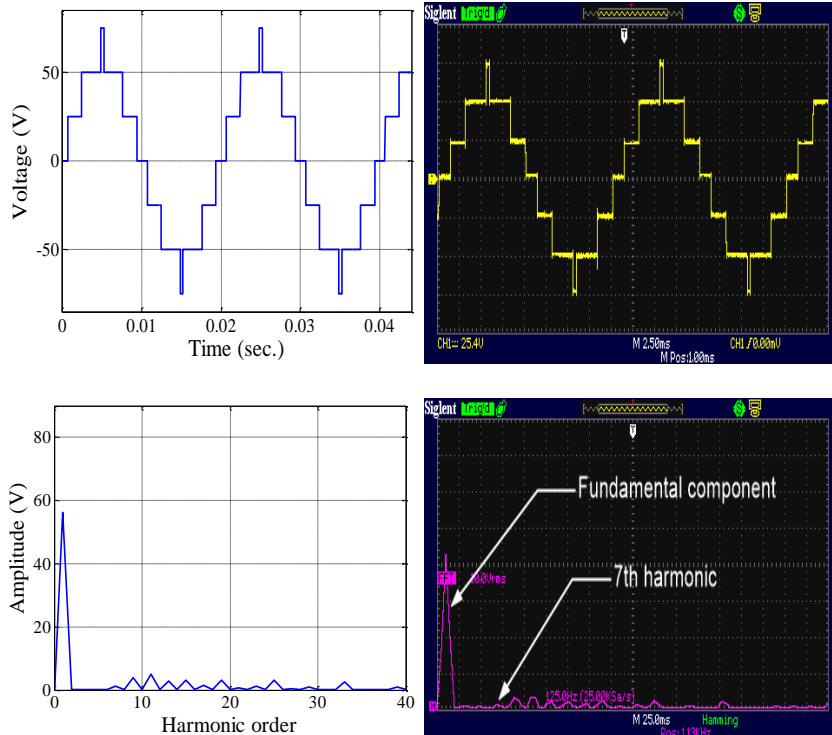

Figure 6: Simulation and experimental results of the output voltage waveform (up) and the corresponding FFT analysis (bottom) for  $r = 0.701$

It can be clearly seen from the simulation and experimental results of the FFT analysis that the 3rd and 5th harmonic are successfully eliminated for the two proposed values of  $r$  and also it can be seen that by decreasing the value of the modulation index  $r$ , the value of the fundamental component decreases significantly therefore the modulation index  $r$  can be considered as a controlling parameter for the value of the output voltage.

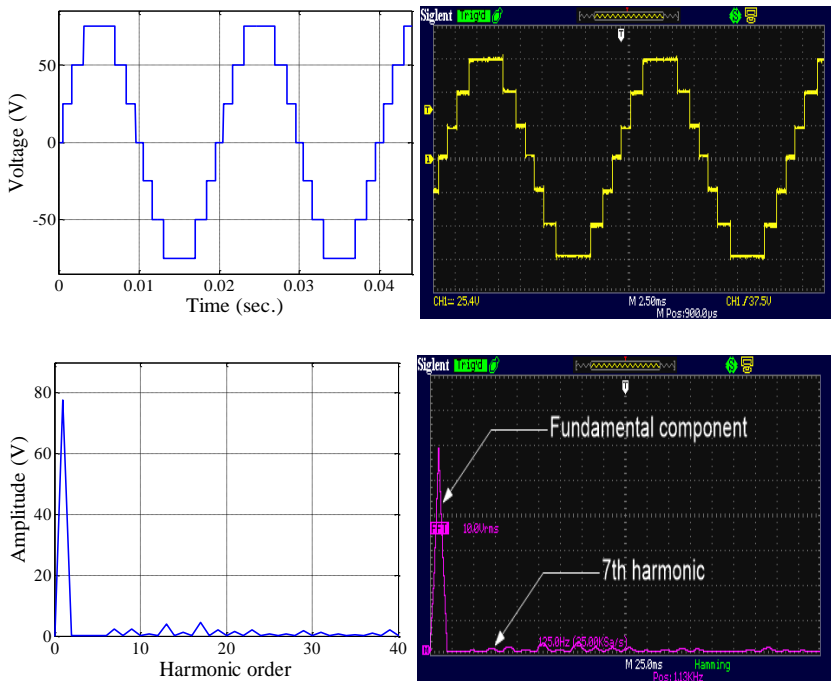

Figure 7: Simulation and experimental results of the output voltage waveform (up) and the corresponding FFT analysis (bottom) for  $r = 1.036$

Figure 8 presents simulation and experimental results of the waveforms generated by the upper cell (H-bridge1) and lower cell (H-bridge2) and it can be clearly seen that the two modules generate different voltage

patterns in order to generate the desired seven level voltage waveform at the output of the inverter.

Table 2 shows the computed total harmonic distortion THD in simulation and the measured values of THD during experiments and it can be seen that experimental results are very close to simulation results.

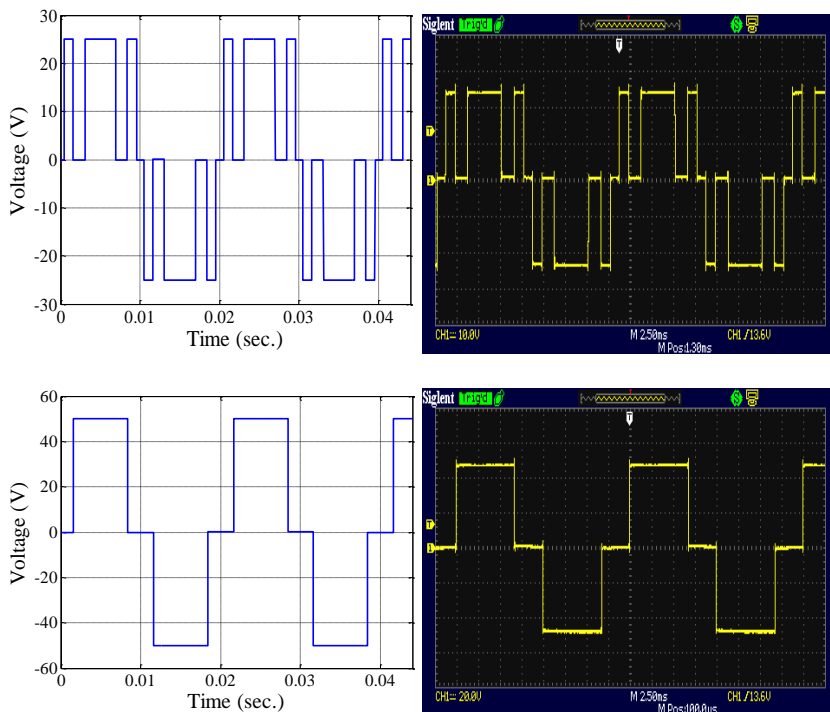

Figure 8: Simulation and experimental results of the waveforms generated by H-bridge 1(up) and H-bridge 2 (bottom)

TABLE 2: Measured THD in (%)

Modulation index	Simulation	Experiment
------------------	------------	------------



Modulation index	Simulation	Experiment
0.701	17.78	16.6475
1.036	11.08	11.56

#### 4. Conclusions

This paper illustrates the use of Newton-Raphson algorithm in selective harmonic elimination for a single phase seven level voltage source inverter to improve the harmonic quality of the generated output voltage. The proposed multi-level inverter with non-equal DC sources has the advantage of generating multiple voltage levels with less switching components. The Newton-Raphson algorithm is used to solve a set of non-linear equations in order to obtain the optimal switching angles to perform the (SHE) modulation strategy. Optimal switching angles are investigated over the range  $r \in [0.7, 0.87]$  and also  $r \in [1.02, 1.04]$ . The validity of the method has been proven by computer simulation using Matlab/Simulink scientific programming environment and verified by experimental hardware set-up. The obtained results from the simulation and hardware show a good agreement with the theoretical prediction.

#### References

- [1] H. Yu, B. Chen, W. Yao, Z. Lu, "Hybrid Seven-Level Converter Based on T-Type Converter and H-bridge Cascaded under SPWM and SVM," in IEEE Transactions on Power Electronics , vol. 33, no. 1, 689-702, 2018.
- [2] K. C. Jana, and S. K. Biswas, "Generalized switching scheme for a space vector pulse-width modulation-based N-level inverter with reduced switching frequency and harmonics", in IET Power Electronics, vol. 8, no. 12, pp. 2377-2385, 2015.
- [3] M. Botao, L. Congwei, Z. Yang and L. Fahai, "New SVPWM control scheme for three-phase diode clamping multilevel inverter with balanced DC voltages," IEEE 28th Annual Conference of the Industrial Electronics Society. IECON 02, 2002, pp. 903-907 vol. 2, 2002.
- [4] E. Deniz, O. Aydogmus, and Z. Aydogmus, "Implementation of ANN-based Selective Harmonic Elimination PWM using Hybrid Genetic



- Algorithm-based optimization", In Measurement, Vol. 85, pp. 32-42, 2016.
- [5] M. Hajizadeh and S. H. Fathi, "Selective harmonic elimination strategy for cascaded H-bridge five-level inverter with arbitrary power sharing among the cells," in IET Power Electronics, vol. 9, no. 1, pp. 95-101, 2016.
- [6] F. CHABNI, R. TALEB and M. HELAIMI, "Differential Evolution based SHEPWM for Seven-Level Inverter with Non-Equal DC Sources", in International Journal of Advanced Computer Science and Applications(IJACSA), vol 7, no 9, pp. 304- 311, 2016.
- [7] Z. Salam and N. Bahari, "Selective harmonics elimination PWM (SHEPWM) using Differential Evolution approach," Joint International Conference on Power Electronics, Drives and Energy Systems & 2010 Power India, New Delhi, 2010, pp. 1-5, 2010.
- [8] A. Kouzou, M. O. Mahmoudi and M. S. Boucherit, "Application of SHE-PWM for seven-level inverter output voltage enhancement based on Particle Swarm Optimization," 7th International Multi- Conference on Systems, Signals and Devices, Amman, 2010, pp. 1-6, 2010.
- [9] M. Tarafdar Hagh, H. Taghizadeh and K. Razi, "Harmonic Minimization in Multilevel Inverters Using Modified Species-Based Particle Swarm Optimization," in IEEE Transactions on Power Electronics, vol. 24, no. 10, pp. 2259-2267, 2009.