

NUMERICAL STUDY OF A HYBRID PHOTOVOLTAIC/THERMAL SOLAR COLLECTOR USING TWO DIFFERENT GLAZING

^{1,2}Amel GHELLAB, ¹Abdennacer KAABI, ²Yassine KABAR

¹Climatic Engineering Department, Faculty of Science and Technologies, Ain El Bey Road, University of Brothers Mentouri 1, Constantine, Algeria

²Applied Energies and Materials Laboratory, Faculty of Science and Technologies, Ouled Aissa, BP 98, University of Jijel, Algeria

Reçu le 19 Janvier 2017 – Accepté le 30 Mai 2017

Résumé

Les matières plastiques ont été révélés les matériaux les plus largement utilisés pour la construction des différents composants tels que les appareils de chauffage solaire. Dans ce travail, une étude numérique sur les performances d'un capteur solaire hybride photovoltaïque / thermique (PV / T) a été développée.

Le but de cette étude est de comparer les rendements du système hybride photovoltaïque / thermique en utilisant des matériaux plastiques comme couverture avec ceux du verre, Le modèle est basé sur le bilan énergétique pour différents noeuds du système. Le système étudié est composé d'un vitrage transparent: le verre ou le poly (méthacrylate de méthyle) (PMMA), ce matériau peut être recyclable, a une grande résistance aux contraintes thermiques et économique par rapport au verre.

Sur la base des résultats numériques, l'utilisation du PMMA est bénéfique pour transmettre plus de la chaleur et améliore les performances thermiques du système étudié, le rendement global du système hybride PV / T est de 88,695% et 87,385% respectivement pour l'utilisation de PMMA ou de verre comme vitrage.

Mots clés : Air; Verre; PMMA; performances; Photovoltaïque / Thermique

Abstract

Plastics are revealed the most widely used materials for the construction of the different components forsolar heating devices In the present work, a numerical study on the performances of a hybrid photovoltaic/thermal (PV/T) air solar collector is developed.

The purpose of this study is to compare the efficiencies of the hybrid PV/T solar system using plastic and glass as cover material. The model is based on energy balance at various nodes of the system; the studied system is composed of a transparent glazing: glass or poly (methyl methacrylate) (PMMA), this material can be recyclable, has high resistance to thermal stresses and economical compared to glass.

On the basis of the numerical results, the use of the PMMA is beneficial to transmit more heat and improve the thermal performances of the system studied and it has been observed that the overall efficiency of hybrid PV/T system are 88.695% and 87.385% respectively for using PMMA or glass as glazing.

Key words: Air; Glass; PMMA; Performances; Photovoltaic/Thermal.

ملخص

المواد البلاستيكية أصبحت على نطاق واسع, أكثر استخداما لبناء المكونات المختلفة لأجهزة التسخين الشمسي. في العمل الحالي، وضعت دراسة عددية حول تطوير أداء مجمع الطاقة الشمسية الهجين الحراري (PV / T), الغرض من هذه الدراسة هو مقارنة فعالية هذا النظام الحراري (PV / T) والذي يستخدم الزجاج كغطاء له مع مجمع طاقة اخر يستعمل المواد البلاستيكية كغطاء

. يستند هذا النموذج على استعمال معادلات توازن الطاقة لعقد مختلفة من النظام؛ و الذي يتكون من الغطاء الشفاف: الزجاج أو البولي ميثاالكريلايت (PMMA), هذا الأخير, يمكن إعادة تدويره , يملك مقاومة عالية للضغوط الحرارية كما انه اقتصادي مقارنة بالزجاج.

المحاكاة العددية أثبتت ان استعمال غطاء البولي ميثاالكريلايت (PMMA) مفيد لنقل المزيد من الحرارة وتحسن الأداء الحراري للنظام المدروس, كما لوحظ ان المردود الكلي لمجمع الطاقة الشمسية الهجين الحراري باستعمال غطاء البولي ميثاالكريلايت اوالزجاج هو على التوالي 88,695% و 87,385% .

الكلمات المفتاحية : الهواء, الزجاج, PMMA, المزاي, الخلايا الكهروضوئية احراري.

INTRODUCTION :

The concept of hybrid photovoltaic/ thermal system (HPV/T) has been developed to generate simultaneously electricity and thermal power, as in this system the solar cell converts solar radiation to electrical energy with peak efficiency in the range of 9-12%, depending on specific solar cell type and thermal energy through fluid heating, more than 80% of solar radiation failing on photovoltaic cells is not converted to electricity, but either reflected or converted to thermal energy [1]. Recently Good [2] revealed in his review, that the association of two technologies in one module has potential to minimize the use of materials, the time of setup and requires space. Ibrahim et al [3] showed that the flat plate photovoltaic thermal (PV/T) solar collector is an optimistic promising system for low energy application in residential, industrial and commercial buildings. Michael et al [4] presented an overview of the different photovoltaic/thermal technologies, their efficiencies, applications, advantages, limitations and research opportunities available. To improve the performance of the hybrid photovoltaic and thermal collectors, various theoretical and experimental researches has been developed, as it is well known that the cell efficiency is decreasing with temperature, so various configurations was been proposed with different structures, materials and working fluids. Cristofari et al [5] have developed a simulation model on a hybrid photovoltaic/thermal system manufactured in a copolymer absorber, they concluded that the use of this material for all design of the solar collector has large advantages, among them the reduce of the cost. Notton et al [6] have modeled a double-glass photovoltaic module. The results showed that the best configuration corresponded to the use of just forced convective coefficient given by Cole et Sturrock (1977). Tiwari et al [7] have studied analytically and validated the results with their experience on four configurations of an unglazed and glazed PV/T solar air collectors with and without tedlar. Joshi et al [8] aimed to study the thermal performance of two type of a hybrid photovoltaic/thermal air collector : hybrid PV/T glass to glass and the comparison with glass to tedlar. It was observed that the better performance was given by the PV module glass-to-glass. Tonui and Tripanagnostopoulos [9] have presented a theoretical and experimental study of a new concepts using suspended metal sheet at the middle of the air channel and fins on the opposite channel wall. Both experimental and theoretical results show that the modifications proposed enhance the performance of the PV/T air system. Hegazy [10] has showed four designs of glazed PV/T air system for single and double pass air heaters; he developed a thermal model of each system, his study provided precious information on the design and operation of the four configurations studied. Recently, Su et al [11] have presented the performance of photovoltaic-thermal (PV/T) solar collector with dual channels for different fluids. They concluded that air-air cooled PV/T collector can supply the majority quantity of hot air where its temperature is the greatest.

The solar collector include covers usually designed in glass due to its properties, Blaga [12] in his review has mentioned that in small applications, the temperature required for space heating and cooling, is relatively moderate, so plastics can be used as a materials for the construction of most of the component parts of the solar system. The same author presented in his paper the manner to use plastics in solar energy installations and cited the plastics commonly used for glazing in solar collectors which are: poly (methyl methacrylate) (PMMA), polycarbonate (PC), and glass-fiber-reinforced polyester (GRP) sheeting, and films of (polyvinyl fluoride) (PVF) and fluorinated ethylene-propylene (FEP) copolymer. Edlin [13] has presented a comparative study between three transparent plastic films with the glass as glazing for solar collector for all angles of incidence and for all solar altitude. The author concluded that plastic films can be used as glazing. The performance ability of non-metallic solar collectors has been well-tested by O'Brien-Bernini and Mc Gowan [14], the authors in their paper encourages the use of plastics in flat plate solar collectors. Koyuncu [15] has investigated experimentally six different types of natural circulation air heating solar collectors with single or double plastic glazing. The study concluded that the performance of solar air heater with single plastic glazing is more than the collector with double plastic glazing. After the literature synthesis, it is encouraging to employ the plastics as covers in solar systems since these materials exhibit a lower density than most engineering materials, the resistance to abrasion of many plastics is superior to glass and they provide better heat and sound insulation. Obviously the PMMA, known by its first time trade name of "Plexiglas :poly (methyl methacrylate)" is the most functioning glazing among the most used since its weight represents only half as much as that of similar thickness made of glass and have relatively high transmission of solar radiation. It has improved resistance to break than glass; its transmission is the equal of the best low-iron glass according to Blaga [12], and its long-term longevity under different climatic conditions. The objective of the present study is making comparison of the efficiencies of two different glazing cover of a hybrid PV/T solar collector which are: glass and Plexiglas (PMMA), under meteorological conditions of Constantine in east Algeria. A numerical study in a transient analysis is developed by writing energy balances for different nodes: glazing, PV cell, absorber, fluid and insulation.

2. DESCRIPTION OF THE PV/T COLLECTOR

A cross sectional view of the proposed photovoltaic/thermal (PV/T) collector is shown in Fig.1. The studied system is composed of a transparent glazing (Glass or PMMA) located at the top of the collector, which transmitted the incident solar radiation to the solar cell and the Tedlar at the bottom of PV/T collector. A fraction of the incident radiation is converted into electricity by the solar cell and the other fraction is communicated to the fluid flowing into a rectangular duct formed by top Tedlar and the insulation. The cooling fluid is flowing under forced

circulation mode. The conduct bottom is insulated in order to minimize heat losses with the ambient. The title angle of the studied hybrid PV/T solar collector is taken equal to the latitude of Constantine east town in Algeria.

$$M_g c_g \left(\frac{dT_g}{dt} \right) = P_g A_g + h_{vg} (T_a - T_g) A_g + h_{rg} (T_s - T_g) A_g + h_{cg} (T_c - T_g) A_g \quad (1)$$

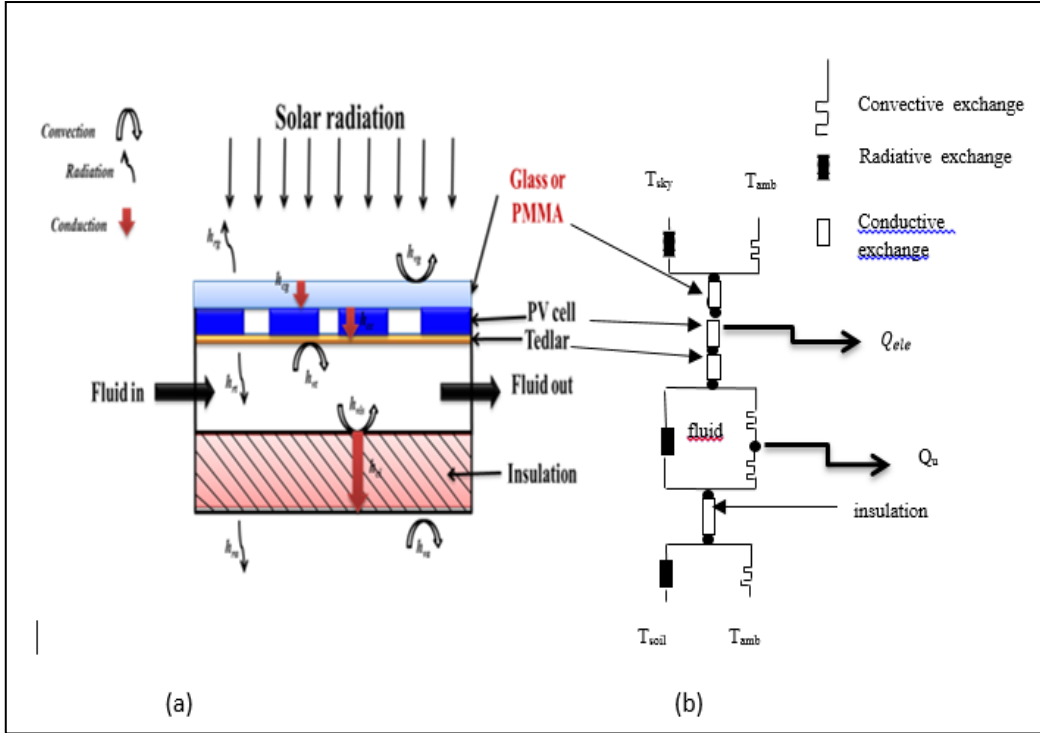

Where M_g , c_g and A_g represents respectively the mass, specific heat and area of glass, P_g represents the rate of the energy absorbed by the glass, h_{vg} is the convective heat transfer coefficient between the glazing and ambiance, h_{rg} is the radiation heat transfer coefficient from the glazing to the sky, h_{cg} is the conduction heat transfer coefficient between the solar cell and glazing T_g , T_a , T_s and T_c represent respectively temperatures of: glazing, ambient, sky and PV cell and t represents the time. The quantity of the solar radiation absorbed by the glazing P_g is computed by the following expression [5]:

Figure 1. (a) A cross sectional view of the hybrid PV/T solar collector. (b) Thermal resistance diagram of the system studied.

3. MATHEMATICAL MODEL :

3.1 Energy balance :

A transient mathematical model under forced convection has been developed to analyze the PV/T performances. In order to write the energy balance between the components, it would be convenient to use the analogy between electricity and heat transfer. Fig.1 shows the different heat transfer coefficients along various elements of the collector. It is necessary to make some assumptions to model the system considered, as:

The sky can be assimilated to a black body with equivalent temperature calculated.

The temperature of the soil is taken equal to the ambient temperature.

The physical proprieties of materials are assumed to be constant.

The wind is supposed blowing parallel to the faces of the system.

The fluid entering the duct is at ambient temperature and the fluid temperature in the duct is an arithmetic mean of the inlet and outlet temperatures.

The energy balance equations for different surfaces of the PV/T collector are written as follows::

The glazing :

$$P_g = I_g \cdot \alpha_g \quad (2)$$

Such as I_g represents the total irradiance incident on the titled system, this amount is estimated by the method developed in detail by Duffie and Backman [16], α_g represents the absorptance of glazing. The radiation heat transfer coefficient from the glazing to the sky is expressed by Swinbankas [17]:

$$h_{rg} = \frac{\sigma \varepsilon_g (T_g^4 - T_s^4)}{(T_g - T_a)} \quad (3)$$

Where σ is the stephan-Boltzmann constant, ε_g is the emissivity of thermal radiation of the glazing cover, T_s characterize the sky temperature which is evaluated by Swinbank as cited by Ong [17]:

$$T_s = 0.0552(T_a)^{1.5} \quad (4)$$

The convective heat transfer coefficient between the glazing and ambiance is formulated by Mc Adams (1954) [17]:

$$h_{vg} = 5.7 + 3.8.V \quad (5)$$

Where V represents the wind velocity.

The conductive heat transfer coefficient between solar cell and glazing can be computed from the following equation:

$$h_{cg} = k_g / e_g \quad (6)$$

k_g and e_g represent the thermal conductivity and the thickness of the glazing.

The solar cell:

$$M_c c_c \left(\frac{dT_c}{dt} \right) = P_c \cdot A_c + h_{cg} (T_g - T_c) A_t + h_{cc} (T_t - T_c) A_c - Q_{sle} \cdot A_c \quad (7)$$

Where M_c , c_c and A_c represents respectively the mass, specific heat and area of the solar cell, P_c represents the rate of the energy absorbed by the PV cell, h_{cc} is the conduction heat transfer coefficient between the PV cell and the tedlar and Q_{sle} is the electrical power produced by the PV module. T_t represents the temperature of the tedlar. P_c represents the rate of solar energy transiting through the cover and absorbed by the PV cell and is computed by the following expression, as suggested by Tiwari et al [18]:

$$P_c = \tau_g \times \alpha_c \times \beta_c \times I_g \quad (8)$$

Where α_c is the absorption coefficient of the cell and β_c is the Packing factor which represents the ratio of cell area to aperture area. While the rate of electrical energy generated by the PV cell can be computed by [18]:

$$Q_{sle} = \eta_{sle} \times I_g \times \beta_c \times \tau_g \quad (9)$$

Where η_{sle} design the electrical efficiency generated by the cell, which is estimated by the relation (26) and τ_g is the transmission coefficient of the glazing.

The conduction heat transfer coefficient between the PV cell and the tedlar is calculated by:

$$h_{cc} = k_c / e_c + k_t / e_t \quad (10)$$

k_c, k_t and e_c, e_t are respectively the thermal conductivity and the thickness of PV cell and the tedlar.

The tedlar :

$$M_t c_t \left(\frac{dT_t}{dt} \right) = h_{cc} (T_c - T_t) A_c + h_{vt} (T_f - T_t) A_t + h_{rt} (T_{is} - T_t) A_t + A_t P_t \quad (11)$$

insulation. T_f and T_{is} represent respectively temperatures of fluid and insulation. P_t represents the rate of solar

transiting through the cover and the PV cell and absorbed by the tedlar, according to [7], it is computed as:

$$P_t = \tau_g \times (1 - \beta_c) \times \alpha_t \times I_g \quad (12)$$

The heat transfer coefficient by radiation between the tedlar and insulation can be given as [17]:

$$h_{rt} = \frac{\sigma (T_t + T_{is}) (T_t^2 + T_{is}^2)}{(1/\varepsilon_{is} + 1/\varepsilon_t - 1)} \quad (13)$$

Where ε_{is} And ε_t are respectively the tedlar and the insulation coefficients of emissivity.

The air flowing in the duct:

$$M_f c_f \left(\frac{dT_f}{dt} \right) = h_{vt} (T_t - T_f) A_t + h_{vis} (T_{is} - T_f) A_{is} - \dot{m} c_f (T_{out} - T_{in}) A_f \quad (14)$$

Where M_f , c_f and A_f represents respectively the mass, specific heat and area of the fluid, h_{vis} is the convection heat transfer coefficient between the fluid and the insulation, T_{in} and T_{out} represent respectively the inlet and the outlet temperatures of the fluid in the duct. \dot{m} is the mass flow rate of air.

For convective exchange between two plates and the fluid inside the duct, the heat transfer coefficient can be calculated by:

$$h_{vt} = h_{vis} = Nu \times k_{air} / D_h \quad (15)$$

Where k_{air} is the thermal conductivity of air, Nu is the Nusselt number for forced convection in the duct formed by the absorbed plate and the back plate. For air as working fluid and according to Incropera [19] and Mahesh [20], the Nusselt number can be expressed by:

For transition flow

$$Nu_{air} = 0.0214 \times (Re_{air}^{0.8} - 100) \times Pr_{air}^{0.4} \times \left[1 + \left(\frac{D_h}{L} \right)^{0.66} \right] \quad (16)$$

Under the conditions: $0.5 \leq Pr_{air} \leq 1.5$, $2300 < Re_{air} < 10^6$ and $0 < \frac{D_h}{L} < 1$ Where M_t , c_t and A_t re

For turbulent fully developed flow

$$Nu_{air} = 0.023 \times Re_{air}^{0.8} \times Pr_{air}^{0.4} \quad (17)$$

For the following conditions: $0.6 \leq Pr_{air} \leq 160$,
 $Re_{air} \geq 10000$ and $\frac{L}{D_h} \geq 10$.

Where Pr_{air} is the Prandtl number of air, Re_{air} is the Reynolds number of air defined as:

$$Re_{air} = \rho_{air} v \cdot D_h / \mu_{air} \quad (18)$$

In which ρ_{air} and μ_{air} represent the density and the dynamic viscosity of air, L represents the length of the collector, D_h represents the hydraulic diameter of the duct and v is the mean velocity of air in the duct, it can be defined as :

$$v = \dot{m} / (\rho_{air} \times A) \quad (19)$$

All fluid proprieties are evaluated at the mean fluid temperature, except $C_{p,air}$ which can be assumed equal 1000 J/kgK. The other physical properties of air are assumed varying with temperature in the range 280-470 K according to Gao [21], as follows:

$$\mu_{air} = (1.6157 + 0.06523 T_f - 3.0297 \times 10^{-5} T_f^2) \times 10^{-6} \quad (20)$$

$$\rho_{air} = 3.9147 - 0.016082 T_f + 2.9013 \times 10^{-5} T_f^2 - 1.9407 \times 10^{-8} T_f^3 \quad (21)$$

$$k_{air} = (0.0015215 + 0.097459 T_f - 3.3322 \times 10^{-5} T_f^2) \times 10^{-3} \quad (22)$$

The insulation:

$$M_{is} c_{is} \left(\frac{dT_{is}}{dt} \right) = h_{vis} (T_f - T_{is}) A_{is} + (h_{ci} + h_{va}) (T_a - T_{is}) A_{is} + h_{rt} (T_t - T_{is}) A_{is} + A_{is} h_{ra} (T_{soil} - T_{is}) \quad (23)$$

Where M_{is} , c_{is} and A_{bis} represent respectively the mass, specific heat and area of the insulation , h_{ci} is the conduction heat transfer coefficient in the insulation, h_{ra} is the radiation heat transfer coefficient from the insulation and soil, h_{va} is the convective heat transfer coefficient for air between the insulation and the soil. T_{soil}

represents the temperature of the soil. The heat transfer coefficient by conduction in the insulation can be obtained by:

$$h_{ci} = k_i / e_i \quad (24)$$

k_i and e_i are respectively the insulating thermal conductivity and thickness. The radiation heat coefficient between insulation and soil is computed by:

$$h_{ra} = \sigma \varepsilon_{is} (T_{soil} + T_{is}) (T_{soil}^2 + T_{is}^2) \quad (25)$$

And the convective heat coefficient between back plate and soil h_{va} can be taken the same as h_{vg} .

3.2 Expression of efficiencies :

The expression of the electrical efficiency generated by the cell is:

$$\eta_{elc} = \eta_{ref} [1 - \beta_r (T_c - T_r)] \quad (26)$$

Where η_{ref} is the reference cell efficiency at operating temperature T_r of 25 °C, and β_r is the temperature coefficient and these parameters are given by manufacturer, according to [18].

The instantaneous thermal efficiency of the PV/T collector can be expressed by the ratio of quantity of heat extracted by the fluid used noted Q_u (W) over a specified time period (between t_1 and t_2) to the amount of solar radiation incident on the glazing over the same time period.

$$\eta_{th} = \frac{\int_{t_1}^{t_2} \dot{m} c_f (T_{out} - T_{in}) dt}{A \int_{t_1}^{t_2} I_g dt} \quad (27)$$

And the overall efficiency of the PV/T solar collector is computed by adding the thermal efficiency equivalent of electrical efficiency and the thermal efficiency [18]:

$$\eta_{overall} = (\eta_{elc} / c_f) + \eta_{th} \quad (28)$$

Where c_f is the conversion factor of the thermal power plant, its value can be taken as 0.36 [8].

3.3 Method of resolution :

Based on the finite difference formulation, the temperature distribution can be determined by a system of linear algebraic equations, these systems can be written as a matrix equation as follows [19]:

$$A (5,5) \times T(5) = B (5) \quad (29)$$

Where A (dimension: 5) represents a square matrix, such its elements join the known thermal capacities of materials with the different heat exchange coefficients between PV/T collector elements, $T(5)$ is a vector containing system of the unknown's temperatures at the nodes and the vector $B (5)$

which join the constants, thermal capacities of materials with the heat exchange coefficients which related with the input physical parameters. This equation system is solved by the iterative Gauss-Seidel method, which allowed evaluating the unknowns for each time and for each component. For numerical calculation, a computer program was prepared in Matlab language. Firstly, initial guessed temperatures are used equal to ambient temperature in order to calculate the heat transfer coefficient, which can be used to estimate (T_g , T_c , T_i , T_f and T_{is}), then the values obtained are reinserted to compute new temperatures of various elements. If all new values are larger than 0.01% from their guessed temperature, the process is repeated until the solution converges.

4 RESULTS AND DISCUSSIONS :
4.1 Numerical validation of the model

The values of the thermo physical parameters for various surfaces of the system which have been used to validate the model are found from literature [8, 11, 22, 23]. The characteristics of different components of the HPV/T used in simulation are shown in Table1; however Table 2 listed the relevant parameters of glass and PMMA. The electrical efficiency is computed by eq. (26), the following values were experimentally validated according to Joshi et al [8] and Tiwari et al [22]: $\beta_r=0.0045 \text{ K}^{-1}$, $\eta_{ref}=12\%$, Packing factor $\beta_c=83\%$.

Table 1. Characteristics of different components of the HPV/T used in simulation

Parameters	PV cells	Tedlar	Insulation
Absorption coefficient (-)	$\alpha_c=0.9$ [8, 22]	$\alpha_t=0.5$ [8, 22]	-
Transmission coefficient (-)	$\tau_c=0.09$ [11]	-	-
Emissivity (-)	$\epsilon_c=0.7$ [23]	$\epsilon_t=0.95$ [23]	-
Thickness (m)	$e_c=0.0003$ [11]	$e_t=0.0003$ [8, 22]	$e_i=50$ [8, 22]
Thermal conductivity($w.m^{-1}.K^{-1}$)	$k_c=148$ [11]	$k_t=0.033$ [8, 22]	$k_i=0.035$ [8, 22]
Density($kg.m^{-3}$)	$\rho_c=2330$ [23]	$\rho_t=1390$ [23]	$\rho_i=24$ [23]
Specific heat capacity($J.kg^{-1}.K^{-1}$)	$c_c=836$ [23]	$c_t=1400$ [23]	$c_i=919$ [23]

Table 2. Main parameters of glass and Plexiglass used in simulation

Parameters	Glass	Plexiglass
Absorption coefficient $\alpha_g(-)$	0.05 [8, 22]	0.04 [8, 22]
Transmission coefficient $\tau_g(-)$	0.91 [8, 22]	0.93 [23]
Emissivity $\epsilon_g(-)$	0.85 [23]	0.86 [23]
Thickness $e_g(m)$	0.003 [8, 22]	0.003 [8, 22]
Thermal conductivity $k_g(w.m^{-1}.K^{-1})$	0.7 [8, 22]	0.2 [23]
Density $\rho_g(kg.m^{-3})$	2700 [23]	1200 [23]
Specific heat capacity $c_g(J.kg^{-1}.K^{-1})$	750 [23]	150 [23]
Refractive index (-)	1.5 [23]	1.49 [23]

Firstly, in order to validate the model of the present work, the program was run on the same experimental data of Joshi et al [8] on a PV/T air collector glass to Tedlar for composite climate of India, they carried out a panel with area of 0.54 m² (Length: 1.2 m, Width: 0.45m) and the gap between tedlar and insulation was equal to 5 cm, the wind velocity was equal to 2 m/s and the mass flow rate of air in the duct was 0.05kg/s according to Su et al [11]. Fig. 2 illustrate the comparison of the solar cell temperature and the outlet air temperature of the present numerical code with the temperatures available in the experimental and analytical study of Joshi et al [8], these authors showed in their study that there was a good agreement between their experimental and theoretical results. Although the results obtained in this paper are in good agreement with those reported by Joshi et al [8]. The solar cell temperature varies from a minimum value of 40.1°C at 17:00 to a maximum of 68.43 °C at 12:00, with a mean square deviation 'e'= 2-19 %, this mean square deviation can be calculated by relation cited by Joshi et al [8] and Tiwari et al [22].

The outlet air temperature varies from a minimum value of 32 °C at 08:00 to a maximum value of 49.2°C at 13:00 ; these values are higher than the experimental values of Joshi et al [8] with 'e'=1-6%. It is believed that these differences may come from making hypotheses and uncertainties in the correlations used in the mathematical analysis.

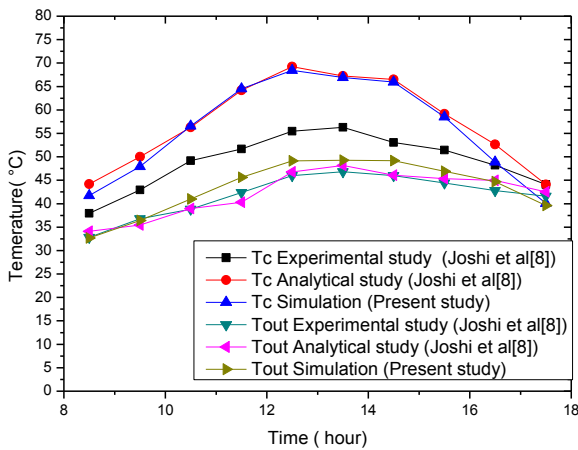

Figure 2. Comparison between present work and Joshi data points (Experimental and analytical work) for the hourly variation of: the solar cell temperature (T_c), the outlet air temperature (T_{out}).

4.2 Evolution of solar intensity and ambient temperature :

The following performance evaluation have been carried out for meteorological data which concern Constantine town in east Algeria ($36^{\circ}70'$, $6^{\circ}37'$), for the typical summer day 11 July 2016, and during which the prevailing maximal and minimal temperatures are respectively equal to 40°C and 19°C , these values are drawn from the weather Web site accuweather[24]. The calculation of the different parameters is during the sunshine and the collector represents an area of 1m long by 1 m wide and the wind speed was taken equal to 2 m/s. Fig. 3 represents the hourly variation of solar intensity and ambient temperature of the typical day. It can be seen that the radiation varies from a minimum value of 207.064 W/m^2 at 7:00 and 17:00 to a maximum value of 939.75 W/m^2 between 11:00 and 13:00.

4.3 Results and discussion :

Figure. 4 represents the hourly variation of the solar cell temperature for both PMMA and glass as cover. It can be seen that the evolution of these temperatures follows that of solar radiation and increases to a maximum of 81.25°C and 73.81°C at 12:00 respectively for PMMA and glass. It is also seen that the solar cell temperature is higher in the system using PMMA than that using glass as glazing, this can be justified by the transmission coefficient of PMMA which is higher than that of the glass, so more solar radiation may be transmitted to the PMMA cell, previously this remark was cited by Blaga [12].

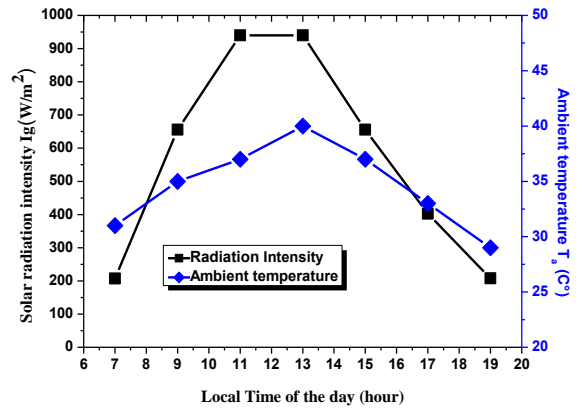

Figure 3. The hourly variation of solar intensity and ambient temperature of the typical day.

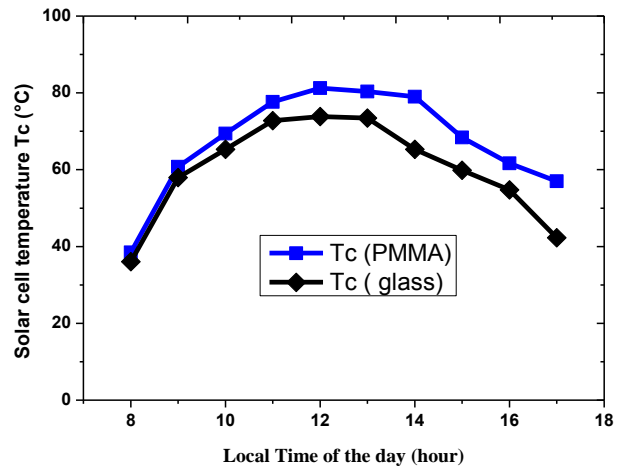

Figure 4. The hourly variation of the solar cell temperature for hybrid PV/T system with different glazing.

The hourly variation of the electrical efficiency for both PMMA and glass was computed by using Eq. (26) then plotted in Fig.5. The electrical efficiency varies between 8.97 % – 11.28 % for PMMA and 9.37% – 11.41 % for glass. It is remarkable that the electrical efficiency for the collector using glass as a cover is higher compared to that using the PMMA, because it is well known that the electrical efficiency decreases when the cell temperature increases. These results are in good agreement with that reported in literature. Fig.6 shows the hourly variation of the electrical power for the glazing studied. The electrical power for PMMA as glazing varies from a minimum value of 18.03W at 8:00 to a maximum value of 66.45W at 12:00 where as for the glass cover it varies from a minimum value of 18.63 W at 8:00 to a maximum value of 69.44 W at 12:00. It is clear from the figure that the electrical power of the collector using PMMA as cover is lower than that using glass as glazing, according to Su et al [11], the electrical power of PV/T collectors depends on the solar radiation intensity when the electrical efficiency changes little.

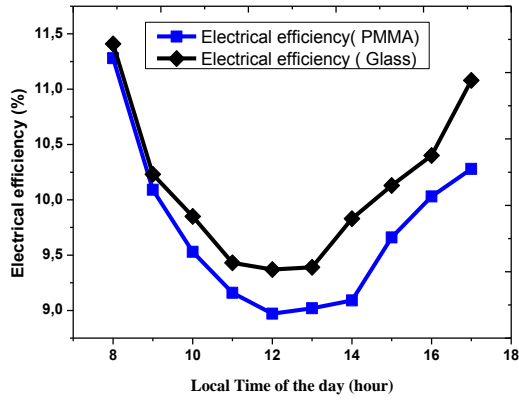

Figure 5. The hourly variation of the electrical efficiency for various glazing covers.

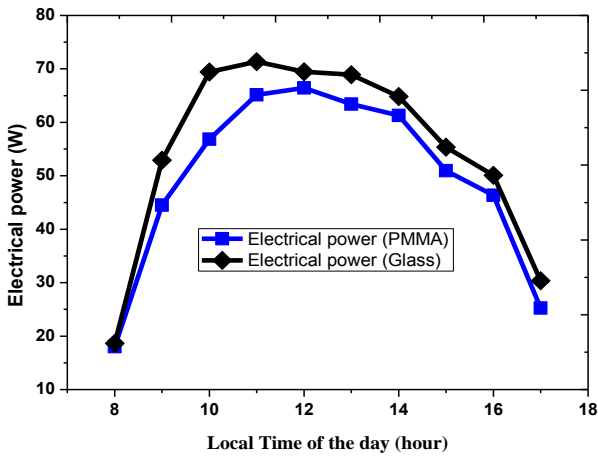

Figure 6. The hourly variation of the electrical power.

Following the results of Figs. 4, 5 and 6, it can be concluded that the electrical properties of the photovoltaic panel will degrade with the increasing in the cell temperature. The rise in the temperature of the system using PMMA as cover, leads to drop the electrical power and the electrical efficiency. The characteristics of the cell used for the calculation are specific to crystalline Silicon solar cells according to Ref [8, 11, 22] so the electrical losses of solar cell can be minimized by using another material for the photovoltaic module which has a good behavior with temperature, as the III-V material of periodic table like GaAs, GaInP according to Abderrezek et al [25] or thin film like CdTe, CdS [26].

Figure 7 exhibits the hourly variation of the outlet air temperature of the two studied cover, as well as the variation of the solar radiation and ambient temperature, the outlet air temperature rises from 8:00 to 12:00 than decreases from 12:00 to 17:00. The maximum computed values of the outlet temperature are found to be 57.96 °C and 61.35 °C at 12:00 respectively for glass and PMMA. It is found that the outlet air temperature of the system using PMMA as cover is higher in comparison to the glass, because the thermal inertia of the glass due to its high specific heat and high absorption coefficient leads to brake

and reduce the transmission of part of the amount of solar radiation.

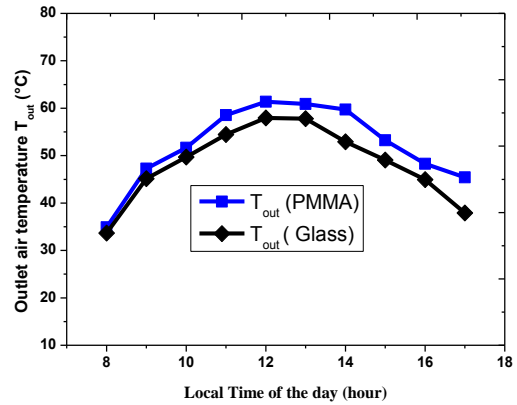

Figure 7. The hourly variation of the outlet temperature for the hybrid PV/T system with both glass and PMMA glazing.

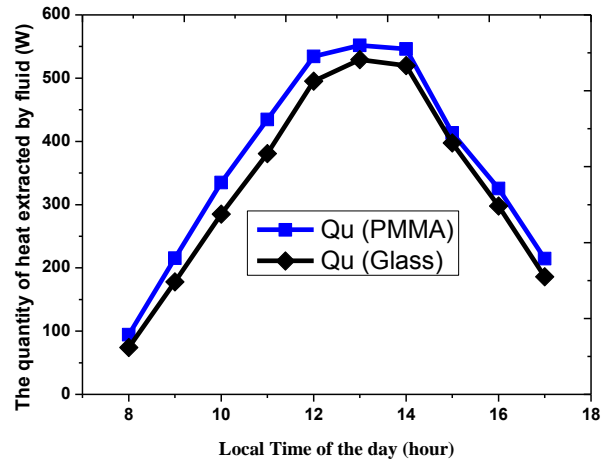

Figure 8. Comparison between the heat extracted by the fluid for hybrid PV/T system using glass or PMMA as covers.

The hourly variation of the quantity of the heat extracted by the fluid of the hybrid PV/T collector using the studied cover is illustrated in Fig.8. It can be seen from the graph that the useful heat acquired by the fluid in the system using PMMA as cover is relatively higher than that using glass and the maximum calculated values of these quantities of heat for the hybrid PV/T system, are obtained as 551.68 W and 529.113 W respectively for PMMA or glass. This is due to the best optical characteristics of PMMA in comparison with those of the glass, which are: low density and heat capacity and higher value of the transmittance coefficient, this can allow this cover to provide more heat to the coolant. The evolution of the thermal efficiency of the hybrid using glass or PMMA as cover is shown in Fig.9. It is seen that for the thermal efficiency of the system using PMMA as glazing represents the better efficiency compared to glass. It is also seen that the maximum values of the

thermal efficiency of the hybrid PV/T system using PMMA or glass as cover are found to be respectively 65.97 % and 62.81%. These results are in good agreement with the results reported by Tripanagnostopoulos [27] and Cristofari et al [5], because at the same time the photovoltaic efficiency decreases with the increase of cell temperature, the thermal efficiency increases.

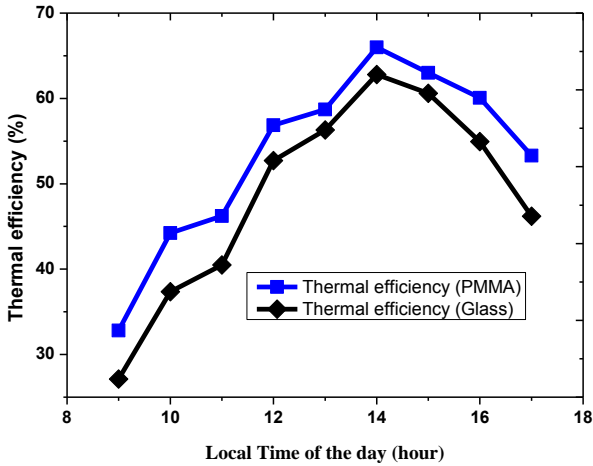

Figure 9. Evolution of the thermal efficiency in the hybrid system using glass or PMMA as cover.

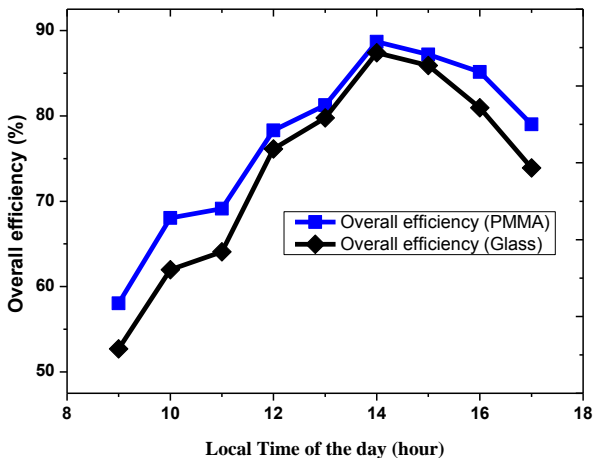

Figure 10. Hourly variation of the overall efficiency for the hybrid PV/T collector using PMMA or glass as glazing.

The hourly variation of the overall efficiency is shown in Fig.10. It can be found from the results of Fig.10 that the curve of the overall efficiency of the hybrid PV/T collector using glass cover is slightly lower than that using PMMA and the maximum values of the overall efficiency for hybrid PV/T system are found to be 88.695 % for PMMA as cover and 87.385 % for glass. This is due to the effect of thermal output caused by the heat provided by PMMA according to the optical characteristic of this material.

5. CONCLUSIONS :

The importance of the covers in hybrid photovoltaic/thermal (PV/T) solar collector, is to transmit almost all the solar radiation to the cell and to the fluid to generate electricity and heat simultaneously. This paper presents the impact of replacing the cover conventionally used which is glass, by a plastic material named PMMA. According to the theoretical results obtained, using different glazing: Glass and PMMA, the following conclusions have been drawn:

- The results obtained are in good agreement with those reported by Joshi et al[8],
- The cell and air outlet temperature of the collector using PMMA are higher than those of the system using glass,
- The system using glass as cover has more electrical efficiency and electrical power than that using PMMA,
- The thermal efficiency and the overall efficiency of the hybrid PV/T system using PMMA as cover are slightly higher to those of the system using glass.

Following the results of the simulation, PMMA gives better thermal performance in comparison to those of glass, but have electrical performance less than the glass, due to the fact of the cell heating, leading to use in the next work an other material for the module which has a good temperature behavior, as III-V material of the periodic table like: GaAs, GaInP or a thin film. The hybrid photovoltaic/thermal collector is used for more than one application, as thermal heating, ventilation, drying and lighting etc, PMMA can be used as cover for this system as in addition to the advantages presented by the present numerical simulation, it should be noted that this material can be modulated, malleable, as it is recyclable, has a good mechanical resistance and less expensive compared to glass. Finally, it is necessary to note that plastics materials are flammable so it is necessary to provide protection means against fire.

Nomenclature :

- A : Area, m^2
 C : Specific heat, $J.kg^{-1}.K^{-1}$
 D_h : Hydraulic diameter, m
 e : thickness, m
 h : Heat exchange coefficient, $W.K^{-1}.m^{-2}$
 I : Solar irradiation, $W.m^{-2}$
 k : The thermal conductivity, $W.m^{-1}.K^{-1}$
 M : Mass, kg
 Nu : Nusselt number
 P : Energy absorbed, $W.m^{-2}$
 Pr : Prandtl number
 Q : Power, W
 T : Temperature, K

V : wind velocity, m.s⁻¹

v : mean velocity in the duct, m.s⁻¹

\dot{m} : Mass flow rate, kg. s⁻¹. m⁻²

Superscript

a : Ambient

c : Conductive exchange, PV cell

ele : electrical

f : fluid

g : Glass

in : inlet

is : insulation

out: outlet

overall: overall

r : Radiative exchange

Ref: reference

s : sky

soil: soil

t: Tedlar

the: thermal

v : Convective exchange

Greek letters

α : absorptivity

β : Packing factor, none, temperature coefficient, K⁻¹

ϵ : emissivity

η : efficiency

ρ : density, kg m⁻³

σ : Stefan-Boltzmann's constant = 5.67.10⁻⁸ W m⁻² K⁻⁴

τ : transmittivity

μ : kinematic viscosity, kg.m⁻¹.s⁻¹

REFERENCES

- [1] G.N. Tiwari, R.K. Mishra, S.C. Solanki, Photovoltaic modules and their applications: A review on thermal modeling. Applied Energy. Vol. 88 (2011).pp. 2287-2304.
- [2] C. Good, Environmental impact assessments of hybrid photovoltaic-thermal (PV/T) systems-A review. Renewable and Sustainable Energy Reviews. Vol.55 (2016).pp. 234-239.
- [3] A. Ibrahim, M.Y. Othman, M.H. Ruselan, S. Mat, K. Sopian, Recent advances in flat plate photovoltaic/thermal (PV/T) solar collectors. Renewable and Sustainable Energy Reviews. Vol. 15(2011). pp. 352-365.
- [4] J.J. Michael, S. Iniyan, R.Goic , Flat plate solar photovoltaic-thermal (PV/T) systems: A reference guide. Renewable and Sustainable Energy Reviews.Vol.51(2015). pp. 62-88.
- [5] C. Cristofari, G. Notton, J. L. Canaletti, Thermal behavior of a copolymer PV/TH solar system in low flow rate Conditions. Solar Energy.Vol. 83 (2009). pp.1123-1138.
- [6] G. Notton, C. Cristofari, M. Mattei, P. Poggi, Modelling of double-glass photovoltaic module using finite differences. Applied Thermal Engineering. Vol. 25 (2005). pp. 2854-2877.
- [7] A. Tiwari, M.S. Sodha, Parametric study of various configurations of hybrid PV/thermal air collector: Experimental Validation of theoretical model. Solar Energy Materials and Solar Cells. Vol. 91 (2007). pp. 17-28.
- [8] A.S. Joshi, A. Tiwari, G.N. Tiwari, I . Dincer, Reddy B.V, Performance evaluation of a hybrid photovoltaic thermal (PV/T) (glass-to-glass) system. International Journal of Thermal Sciences. Vol. 8 (2009). pp. 154-164.
- [9] J.K. Tonui, Y. Triapanagnostopoulos, Air-cooled PV/T solar collectors with low cost performance improvements. Solar Energy. Vol.81(2007). pp. 498-511.
- [10] A. Hegazy, Comparative study of the performances of four photovoltaic/thermal solar air collectors. Energy Conversion and Management. Vol.41(2000). pp. 861-881.
- [11] D. Su, Y. Jia, G. Alva, Y. Tang, G. Fang, Dynamic performance analysis of photovoltaic-thermal solar collector with dual channels for different fluids. Energy Conversion and Management. Vol.120(2016). pp. 13-24.
- [12] A. Blaga, Use of plastics in solar energy applications. Solar Energy. Vol. 21(1978). pp. 331-338.
- [13] F. E. Edlin, Plastic glazing for solar energy absorption collectors. The Annual Meeting of the American Society of Mechanical Engineers,New York. December, 1957. pp. 1-6.
- [14] F.C.O.Brien Bernini, J.G. McGowan, Performance of non-metallic flat plate solar collectors. Solar Energy. Vol.33 (1984). pp.305-319.
- [15] T. Koyuncu, Performance of various designs of solar air heaters for crop drying applications. Renewable Energy. Vol. 31 (2006). pp.10073-1088.
- [16] A. DuffieJ, W. A. Beckman, Solar Engineering of Thermal Processes, John Wiley&SonsInc, New York, 1991.
- [17] K. S. Ong, Thermal performance of solar air heaters: Mathematical model and solution procedure. Solar Energy. Vol.55(1995). pp. 93-109.
- [18] G. N. Tiwari, S. Dubey, Fundamentals of Photovoltaic Modules and Their Applications, RSC Energy. Series N° 2. 2010.
- [19] F. P. Incropera, Fundamentals of Heat and Mass Transfer. Johns Wiley &Sons, 2006.
- [20] Mahesh.M.Rathore, Engineering Heat and Mass Transfer. Laxmi Publications (P) LTD , 2006.
- [21] W. Gao, W. Lin, T. Liu, C. Xia, Analytical and experimental studies on the thermal performance of cross-corrugated and flat plate solar air heaters. Applied Energy.Vol. 84 (2007). pp. 425-441.
- [22] A .Tiwari, M.S Sodha, A .Chandra, J.C. Joshi, Performance evaluation of photovoltaic thermal solar air collector for

- composite climate of India. *Solar Energy Materials and Solar Cells*. Vol. 90 (2006). pp. 175-189.
- [23] J.P. Holman, *Heat Transfer*. 10th ed., McGraw-Hill series in Mechanical Engineering, 2010.
- [24] <http://www.accuweather.com/fr/dz/constantine/> Accessed 30 Jun 2016.
- [25] M. Abderrezek, M. Fathi, S. Mekhilef, F. Djahli, Effect of Temperature on the GaInP/GaAs Tandem Solar Cell Performances, *International Journal of Renewable Energy Research*. Vol.5 N°2 (2015). pp. 629-635.
- [26] P. Singh , N.M. Ravindra, Temperature dependence of solar cell performance-an analysis. *Solar Energy Materials & Solar Cells*. Vol.101(2012). pp. 36-45.
- [27] Y. Triapanagnostopoulos, Aspects and improvements of hybrid photovoltaic/thermal solar energy systems. *Solar Energy*. Vol. 81 (2007). pp. 1117-1131.