

An investigation of incremental conductance based maximum power point tracking for photovoltaic water pumping system performances

Kodji Deli ^{1*}, E.T. Houdji ¹, N. Djongyang ¹, A. Ayang ^{1,2} and J.G. Tamba ³

¹ Department of Renewable Energy, National Advanced Polytechnic
School of Engineering of Maroua, P.O. Box 46, Maroua, Cameroon

² School of Engineering, University of Québec in Abitibi-Témiscamingue (UQAT),
445 Boulevard de l'Université, Rouyn-Noranda, QC J9X 5E4, Canada

³ Department of Thermal Energy Engineering
University Institute of Technology
University of Douala, P.O Box 8698 Douala, Cameroon

(reçu le 28 Septembre 2018 - accepté le 29 Septembre 2018)

Abstract - *In this work, each components of the photovoltaic water pumping system have been modeled in the Matlab/Simulink platform using meteorological data obtained from the field for the specific month corresponding to the hottest one of the year and for different total heads or pump loads. Optimization is done using the incremental conductance MPPT techniques which help to track the maximum power available in the photovoltaic module at each time and then feed the pump with optimal power. The results of this simulations show the effectiveness of the optimized system compare to the direct-coupled one. For the considered water pumps, daily flow rates are predicted and permit to calculate monthly total volume of water which is in the range of 122 m³ to 200 m³ for the total heads in the range of 60 m to 24 m with optimization and in the range of 12 m³ to 43 m³ for the same range of total heads without optimization. This study also shows the relevance of the optimized system compare to the direct-coupled system for providing water in rural areas of soudano-sahelian zone of Cameroon.*

Résumé - *Dans ce travail, chaque composant du système de pompage d'eau photovoltaïque a été modélisé dans la plate-forme Matlab/Simulink à partir de données météorologiques obtenues sur le terrain pour le mois spécifique correspondant au mois le plus chaud de l'année et pour différentes hauteurs manométriques totales ou charges des pompes. L'optimisation s'effectue à l'aide des techniques de conductivité incrémentale MPPT qui permettent de suivre la puissance maximale disponible dans le module photovoltaïque à chaque instant et d'alimenter la pompe avec la puissance optimale. Les résultats de ces simulations montrent l'efficacité du système optimisé par rapport au système à couplage direct. Pour les pompes à eau considérées, des débits journaliers sont prévus et permettent de calculer des débits mensuels totaux d'eau qui sont de l'ordre de 122 m³ à 200 m³ pour des hauteurs totales de 60 m à 24 m avec optimisation et de 12 m³ à 43 m³ pour la même hauteur totale sans optimisation. Cette étude montre également la pertinence du système optimisé par rapport au système à couplage direct pour l'approvisionnement en eau dans les zones rurales de la zone soudano-sahélienne du Cameroun.*

Keywords: PV water pumping systems - Soudano-sahelian zone - Optimization - Modeling - Prediction.

1. INTRODUCTION

Given the increase in the greenhouse gas emission rate, resulting in climate change and significant natural disasters, the use of non-polluting energies has emerged as an appropriate solution. Climate change driven by the use of fossil fuels is also the cause of scarcity of water resources [1, 2]. Surface water is becoming increasingly scarce and of

* delikodji27@yahoo.fr

poor quality, limiting their use to rural areas and is most of the time the cause of several diseases and death in low and middle income nations [3, 4].

Groundwater seems to be the best alternative to this dilemma [5, 6]. Photovoltaic solar power has grown significantly during this decade and is positioned as the best alternative for pumping water. This rapid growth is due to its significant potential as a renewable energy source. In the last ten years, cumulative installed capacity has grown at an average rate of 49% per year.

In 2013, about 37 GW of new PV capacity was installed in about 30 countries or 100 MW per day bringing total global capacity to over 135 GW [7, 9]. Crystalline silicon (c-Si) modules, currently dominate the PV market with around 90 % share [9]. Depending on their efficiency and cost-efficiency rate, PV water pumping systems are becoming very popular.

They have been developed to appear in these following categories [10]: Directly coupled PVWPS which pump water only when the photovoltaic modules capture the solar radiation; Maximum Power Point PVWPS which include MPP trackers to enhance the panels efficiency and thus increase the pumped water volume; Batteries PVWPS which include batteries to supply pumps when the panels power generation is not sufficient.

And Sun trackers PVWPS which include sun trackers to maximize the solar energy received. They are considered expensive and complicated to implement [11]. Over the past decades several algorithms for MPPT have been developed and validated [12, 13], namely, the Look-up table MPPT [14], the Neuro-Fuzzy [15], the Incremental Conductance [15] and the Perturbation and Observation (P&O) algorithms [16].

These techniques differ in many aspects such as required sensors, complexity, cost, range of effectiveness, convergence speed, correct tracking when irradiation and/or temperature change, hardware needed for the implementation or popularity, their advantages and their necessity to control the operating point to extract the maximum power from the PV array but they all require the sensing of the PV current and voltage using the off-the-shelf hardware to generate the duty cycle α used to control converters, such as choppers. [17, 27].

Among the most used we distinguish, the Incremental Conductance algorithm which does not fail during its execution and cannot therefore result in a decrease in power during the operation of the system it appears as a most precise method [28, 30]. This paper focuses on the study of the incremental conductance MPPT techniques which is the most precise technique for extracting power from PV [10] using measured climatic data of the target area.

The relevance of using such technique in gaining energy, for a specific application (water pumping installation in a rural area), is detailed by comparing their efficiencies with a similar installation that is not equipped with MPPT (direct coupled system) into the Matlab/Simulink platform.

2. STUDY AREA AND DATA

Soudano-sahelian zone of Cameroun is a Tropical area, It is located between the latitude 6°N and 13°N and between longitude 11°E and 16°E, and covers three administrative regions (Far North, North and Adamaoua). It shares its boundaries with Nigeria, Central African Republic and Chad Republic [31].

The mean annual rainfall ranges between 400 mm to 1800 mm. The mean annual temperature during the period 1960-2010 ranges between 24 °C and 27.9 °C in the Adamaoua region and from 28 °C to 34 °C in the North and Far-North regions [32].

Rainfall is scarce and dry seasons are more arid as one move away from the equator. The relative humidity is less than 60 % and the insolation is up to 2500 hrs/year [33]. In this part of the country water is the primary source of life for mankind and one of the most basic necessities for rural development. The rural demand for water for domestic water supplies and crop irrigation is increasing.

Particularly for the hot months of the dry seasons where installed water pumping systems are unable to satisfied water demand of the population despite the fact that these months have the strongest solar irradiation of the year. The water needs of a population depend mainly of its lifestyle, the environment and climatic conditions of each region. Drinking, cooking, washing and bathing are the main uses of water for human needs. Animals also need water for their survival. The water use is also essential in the field of agriculture. For humans, the quantity for the normal living condition in Africa is 30 l/day/person [34].

3. SIZING AND MODELING OF A PV WATER PUMPING SYSTEMS

The photovoltaic pumping system is sized on the basis of the findings from a local data survey. Many systems are based on the known data of a nearby reference location for which relevant measured values are available.

If it is possible to visit the intended location, the following field data should be gathered: water quality, demand for water in the supply area, pumping head with allowance for friction losses and well dynamics, geographical peculiarities. The technical planner can choose from a number of design methods of various qualities[35-38].

There are still many obstacles inhibiting a larger implementation of PV pumping systems [39]. Among these problems, there is a lack of accurate tools for the prediction of the system performances. To achieve improvements in PV pumping design, it is necessary to study and model photovoltaic water pumping systems.

Some authors developed algorithms to determine the optimum sizing for the PV water pumping installation depending on the load demand and the site characteristics [40, 41], demonstrating that an optimum sizing allows to decrease considerably the water pumping installation cost [42].

Other researchers concentrated on the optimum use of the photovoltaic energy generated by establishing management algorithms using intelligent tools, namely Fuzzy logic [43, 44]. A good sizing and energy use require an efficient extraction of the photovoltaic power. This requires the use of a technique that allows extracting the maximum PV power generated, known as Maximum Power Point Tracking or MPPT [43].

4. MATERIALS AND METHODS

The system studied consists of the PV generator, the DC-DC converter (Buck / Boost type chopper) and the motor-pump unit. The DC-DC converter is controlled by a search strategy of the maximum power point MPPT. Figure 1 show the overview of the entire system.

The MPPT command imposes a control action on the converter by performing a duty cycle modulation. The latter will then enable the converter to be controlled in order to continue and supply the maximum power that can be delivered by the photovoltaic module at any instant for powering the motor-pump unit.

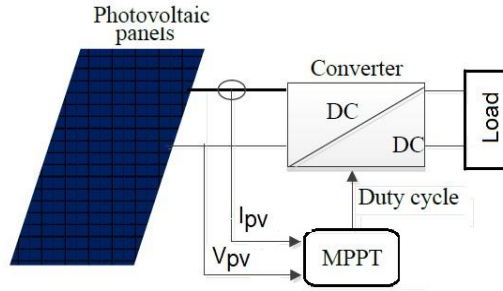

Fig. 1: DC-DC adaptation of the PV generator to a load

4.1 Modeling the PV Generator

4.1.1 Theoretical model of PV generator

An analytical model is proposed here to characterize PV cells. The proposed expressions, based on explicit methods, allow the current and the voltage at key operational points (maximum power point) to be calculated using the single-diode model as a function of cell temperature, irradiance and common manufacturers’ data. The electrical circuit used for modeling the operation of the PV generator is represented in figure 2 below.

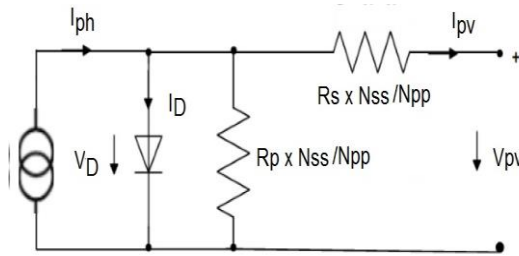

Fig. 2: Equivalent electric circuit for the PV module

The expression of the current delivered by this photovoltaic solar generator can be expressed by equation 1:

$$I_{pv} = I_{ph} - I_{sat} \left(\exp \left(\frac{V_{pv} + R_s \times I_{pv} \times \frac{N_{ss}}{N_{pp}}}{V_{th}} \right) - 1 \right) \times N_{pp} - \frac{V_{pv} + R_s \times I_{pv} \times \frac{N_{ss}}{N_{pp}}}{R_p \times \frac{N_{ss}}{N_{pp}}} \quad (1)$$

$$V_{th} = n_{cell} N_{ss} nkT^c / q \quad (2)$$

Where, I_{pv} , is Current supplied by the PV generator, (A); V_{pv} , Voltage at the terminals of the PV generator (V); V_{th} , Thermal voltage [23 mV at 300 K for one cell]; n_{cell} , Number of cells in series; N_{ss} , Number of module in series; N_{pp} ; Number of module in parallel; k , Boltzmann Constant ($8.65 \times 10^{-5} \text{ eV/K} = 1.381 \times 10^{-23} \text{ J/K}$); T^c : Cell Temperature (K); I_{sat} , is the dark current (A); n , Ideality factor; (Ω); R_s : Serie resistance, (Ω); R_p , Shunt resistance, (Ω); I_{ph} , is the photocurrent related to the illumination level, (A).

In this formula, the voltage of the diode is expressed as follows:

$$V_d = V_{pv} + R_s \times I_{pv} \times \frac{N_{ss}}{N_{pp}} \tag{3}$$

$$I_{ph} = \frac{G}{G_0} \times (I_{ph,T_0} - \gamma(T^c - T_0)) \times N_{pp} \tag{4}$$

Where, G , Solar irradiance, W/m^2 ; G_0 , is the reference solar irradiance, $1000 W/m^2$; T_0 , Reference temperature; γ , Current Temperature Coefficient (Usually given by the manufacturer on the catalog in percent by degrees Celsius); I_{ph,T_0} , is the short circuit current given by manufacturer.

The operating temperature T^c of the cell depends on the irradiance G and the ambient temperature T_a , according to the following empirical equation for polycrystalline photovoltaic module [45, 47].

$$T^c = T_a + \frac{T_{NOCT} - 20}{800} G \tag{5}$$

4.2 Modelling of the converter

4.2.1 Theoretical method

A static converter of the Buck-Boost / Switch-Survolter is a converter which converts a DC voltage into another DC voltage of higher or lower value in the order of magnitude of the duty cycle. This particular type of converter can operate as a reverser when the duty cycle imposed on it is less than 0.5 and as the booster when it is greater than 0.5.

During the MPP tracking, the converter will operate as a step-down on one track and as a booster on another. During the "on" state, the energy supplied by the source (PV generator) is stored in the inductance L (figure 3-a). The energy stored in the inductance L is then delivered to the load during the "off" state (figure 3-b).

Due to the presence of the diode D , the current flows through the inductance L only in one direction during both states. Therefore, V_{load} has a polarity opposite to V_{pv} for this reason, this circuit is also called an inverter converter.

The equation connecting the input voltage and the output voltage can be written in the form given by (6). The capacitor C_1 supports the supply voltage V_{pv} , C_2 smoothes the voltage of the load. The amplitude of V_{load} may be lower or higher than V_{pv} depending on the value of the duty cycle [48], for this reason it can operate as a booster or as a buckler.

$$V_{load} = -\frac{t_{on}}{t_{off}} V_{PV} = -\frac{\alpha}{1 - \alpha} V_{PV} \tag{6}$$

4.3 Modeling of the converter with the MPPT incremental conductance algorithm

4.3.1 Theoretical model of the incremental conductance algorithm

The Incremental Conductance for MPPT depends on the array terminal voltage V_{pv} , which is always adjusted according to the MPP voltage V_{mpp} , based on the

instantaneous and incremented conductance of the photovoltaic module I_{pv} / V_{pv} and dI_{pv} / dV_{pv} , respectively, which are tested following (7), (8) and (9) [15, 41].

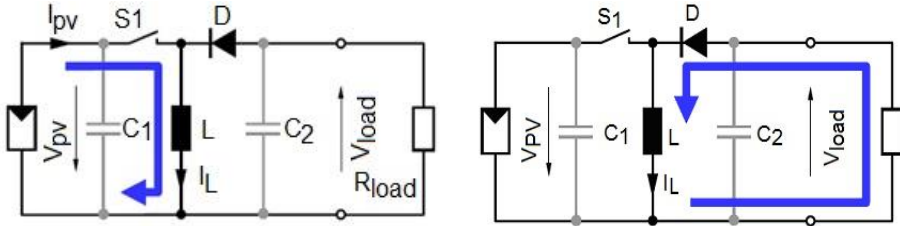

Fig. 3: Buck - Boost converter during on state (a) and off state (b)

$$\text{If } \frac{dI_{PV}}{dV_{PV}} > -\frac{I_{PV}}{V_{PV}}, \text{ then the working point is on the left of the MPP} \quad (7)$$

$$\text{If } \frac{dI_{PV}}{dV_{PV}} < -\frac{I_{PV}}{V_{PV}}, \text{ then the working point is on the right of the MPP} \quad (8)$$

$$\text{If } \frac{dI_{PV}}{dV_{PV}} \approx -\frac{I_{PV}}{V_{PV}}, \text{ then the working point is at the MPP} \quad (9)$$

Hence, by comparing these conductance values following (7) to (9) at each sampling time, the algorithm tracks the maximum power of the photovoltaic module [44]. The changes in G and T_a are also verified when $dI_{PV} = 0$ and $dV_{pv} = 0$. Indeed, in this condition, the solar radiation has not changed. When $dI_{PV} > 0$, the voltage at the MPP increases and thus, the algorithm must increase V_{PV} to track V_{mpp} . Thus, this method allows the MPP to be tracked independently of the module characteristics [14]

4.4 Modeling of the pump and its selection

4.4.1 Pump selection

For the pumping system modeling, we chose a Lorentz pump model PS200-HR-04-MPPT with a nominal voltage of 48 V and capable of pumping up to 60 m. A typical performance curves, reflecting the rendering of the operating parameters characterizing it, such as: flow rate, efficiency and power; are supplied by the manufacturer in their catalog.

4.4.1 Pump selection

After choosing the pump under PVSYST6.1.0, we have used the set of $Q = f(P_{el}, \eta)$ curves available in its catalog, in order to best adjust the relationship between these variables.

Different relationships are then modeled under Matlab/Simulink environment and can be assimilated to the model of this particular pump. The mathematical function which best suits the experimental data governing the operation of the pump is given by equation 10. This is a template from the PVSYST6.1.0 software.

$$Q \text{ (m}^3/\text{h)} = f(P_{el} \text{ (W)}) = p_1 P_{el}^2 + p_2 P_{el} + p_3 \quad (10)$$

p_1, p_2, p_3 are coefficient which are determined experimentally. These coefficients depend on the total discharge head of pump (TDH). The values obtained from PVSYST6.1.0 for different Heads are presented in **Table 1**.

Table 1: Values of coefficients p_1, p_2, p_3 for different Heads for Lorentz pump model PS200-HR-04-MPPT

TDH	24 m	30 m	40 m	60 m
P_1	$-4.97 \cdot 10^{-6}$	$-3.29 \cdot 10^{-6}$	$-1.23 \cdot 10^{-6}$	$1.35 \cdot 10^{-6}$
P_2	$5.55 \cdot 10^{-3}$	$4.88 \cdot 10^{-3}$	$4.04 \cdot 10^{-3}$	$2.75 \cdot 10^{-2}$
P_3	$-1.4 \cdot 10^{-2}$	$-2.08 \cdot 10^{-2}$	$-2.96 \cdot 10^{-2}$	$-5.01 \cdot 10^{-2}$

4.5 Simulation of the model under MATLAB/Simulink

4.5.1 Simulation of PV generator

We have developed a Simulink model of the system using the Simpower libraries. The implementation under Simulink of the model of the photovoltaic generator that we will use is illustrated in figure 4 below:

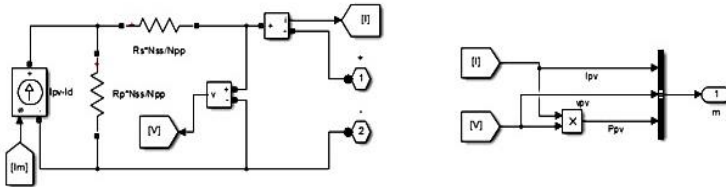

Fig. (4)

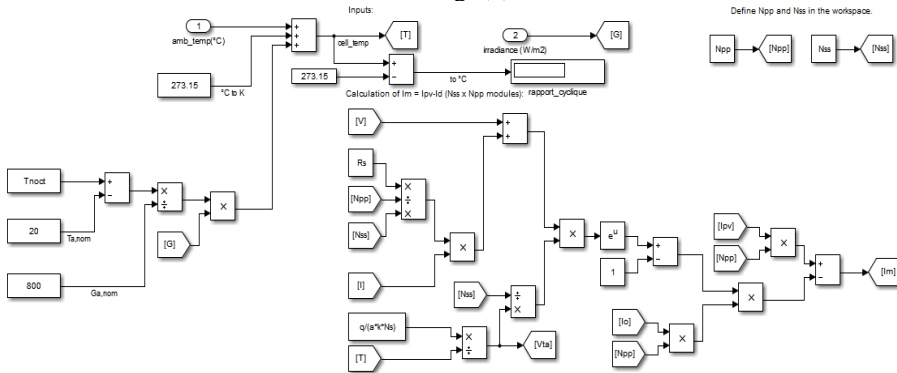

Fig. 4(b)

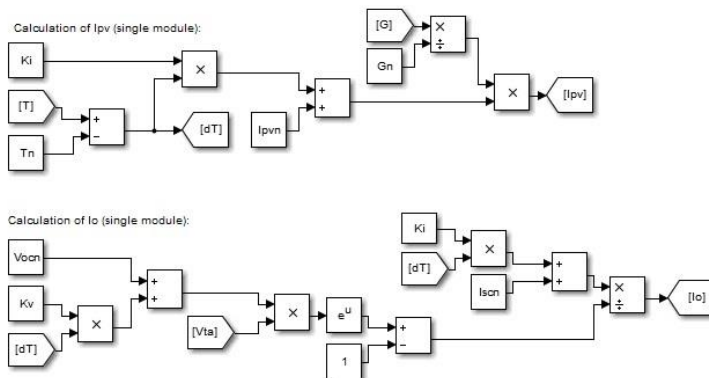

Fig. 4(b)

Fig. 4: Simulation model of the PV generator under Matlab/Simulink

4.5.2 Simulation of the converter

As mentioned above, the converter used in this work is conventional DC-DC converter (Buck / Boost type chopper). The Simulink model is shown in figure 5. The duty cycle is provided by the MPPT algorithm simulated in a separated Matlab block.

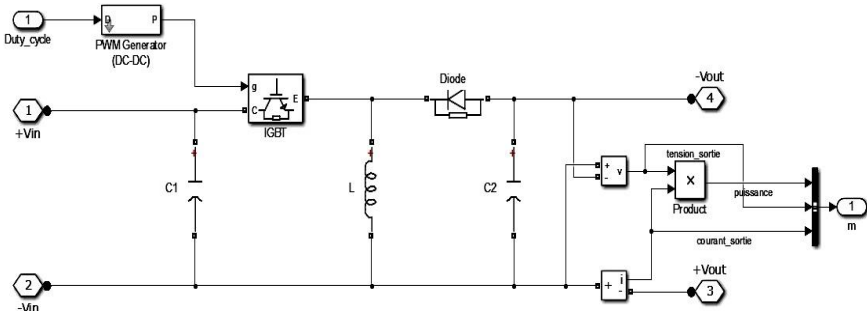

Fig. 5: Simulation model under Matlab/Simulink of the DC / DC converter

4.5.3 Simulation of the whole system

Once each component of the PV water pumping system is modeled, the Matlab / Simulink simulation model of the whole system is built and presented in figure 6.

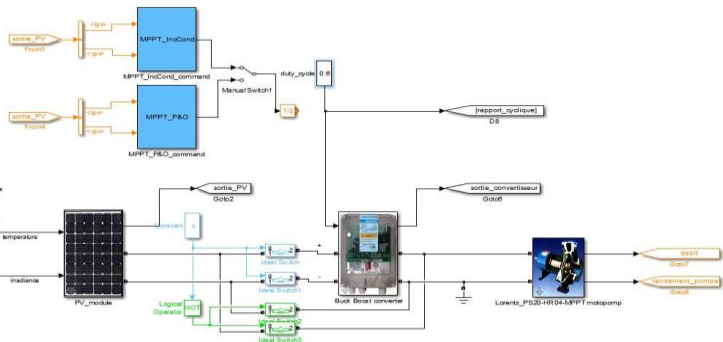

Fig. 6: PV water Pump system Simulink model

5. RESULTS AND DISCUSSION

5.1 Profile of irradiance and temperatures

Experimental data are provided from a measuring station in the city of Maroua (10°28'N; 14°16'E Alt: 423 m).

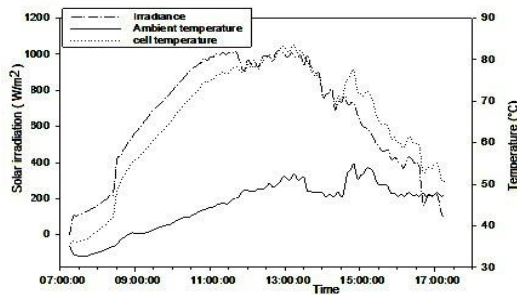

Fig. 7: Irradiance, Ambient and cells temperatures for a sunny day

In order to have precise data, measures have been done between 7 am and 6 pm at regular intervals of five minutes for smoothest. These data consist on temperature and irradiance as shown in figure 7 for sunny day, figure 8 for semi cloudy day and figure 9 for cloudy day. In these figures, cells temperatures were plotted using the equation (5).

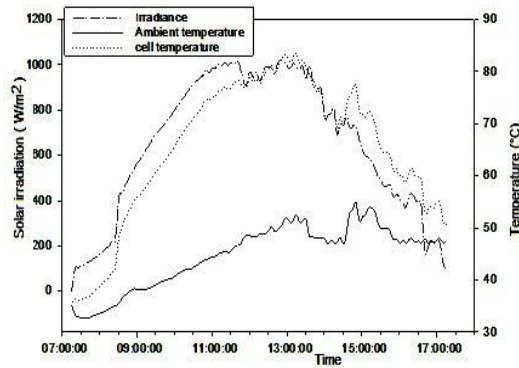

Fig. 7: Irradiance, Ambient and cells temperatures for a sunny day

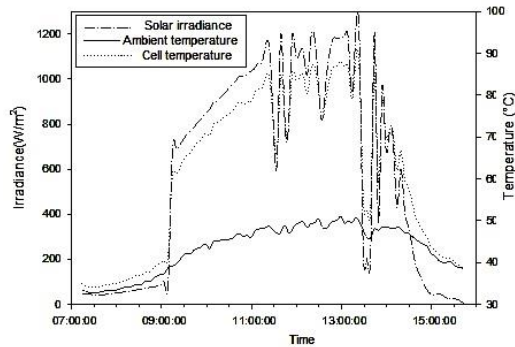

Fig. 8: Irradiance, ambient and cells temperatures for a semi cloudy day

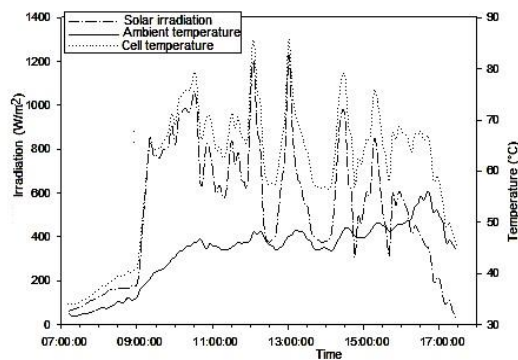

Fig. 9: Irradiance, ambient and cells temperatures for a cloudy day

5.2 Profile of water flow rate

The Matlab/Simulink simulation model of the PVWPS is used in order to predict the monthly or annual water flow rate of the water pumping stations. Daily measured data of irradiance and temperature are used for simulation and the profile of water flow rate during each day of measured data are obtained.

Profile of the water flow rate for the optimized algorithm are presented in the figure 10 and 11 respectively for cloudy and sunny day. It can be observed that the flow rate of the pump has the same profile as the irradiation of the day.

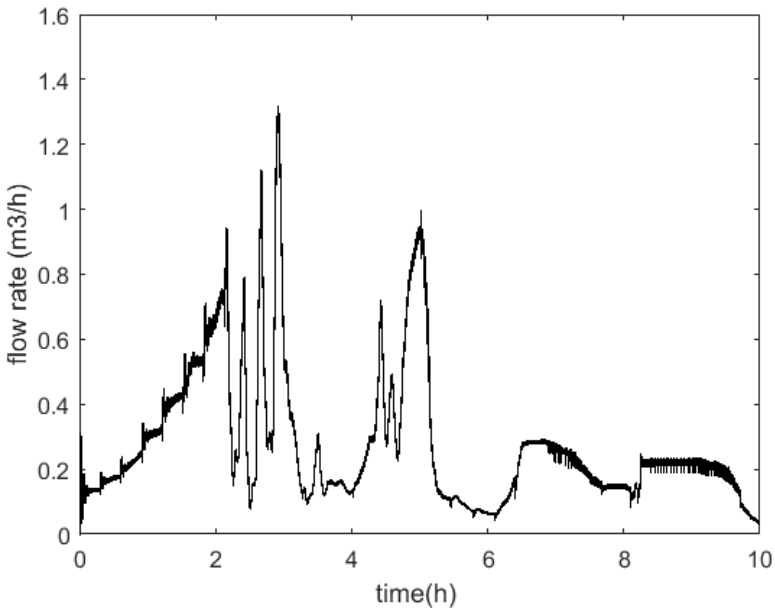

Fig. 10: Water flow rate during cloudy day

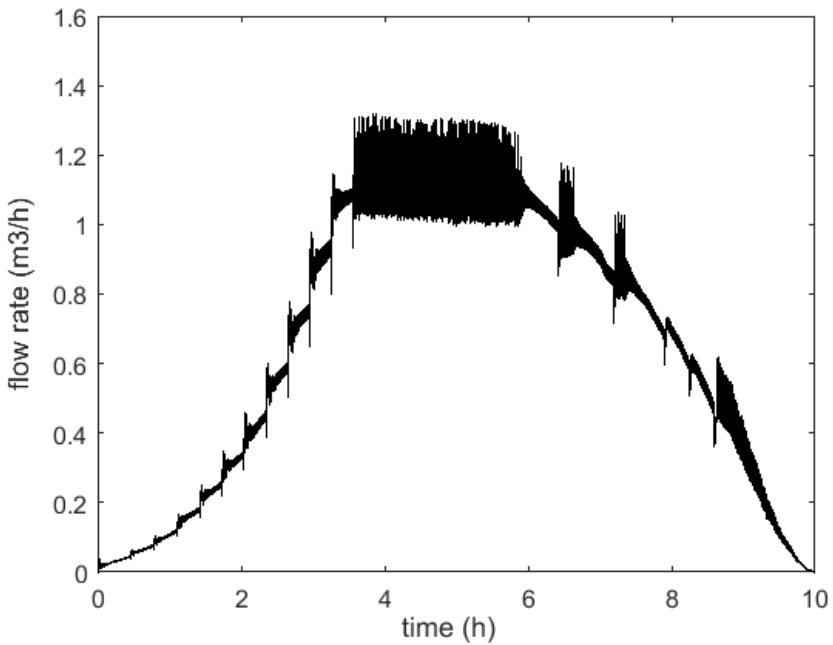

Fig. 11: Water flow rate during sunny day

5.3 Profile of water volumes

For each day of the month, the water volume is assessed from day to day water flow rate profile, for the following total heads: 24 m, 30 m, 40 m and 60 m. This volume corresponds to the area under the flow rate curve as function of time. Figure 12 and 13 present the water volumes for different head and for optimized (Opt-V) and direct-coupled system respectively.

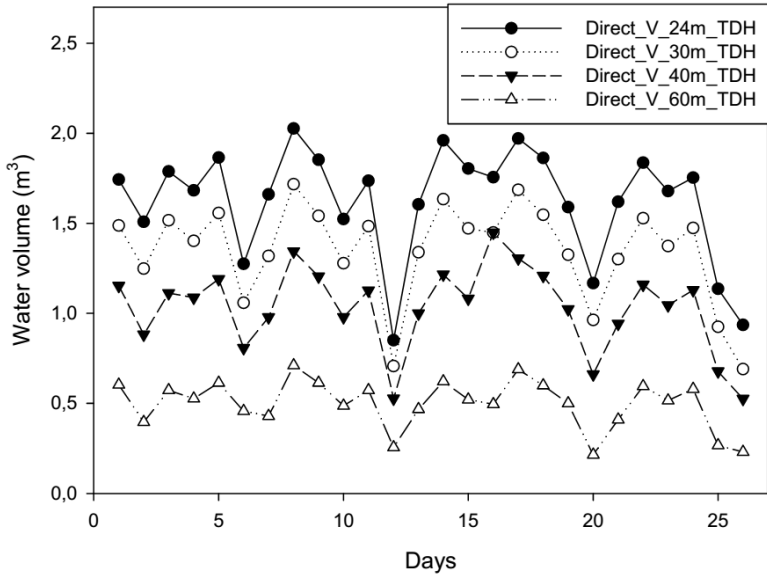

Fig. 12: Water volume for different heads for direct-coupled

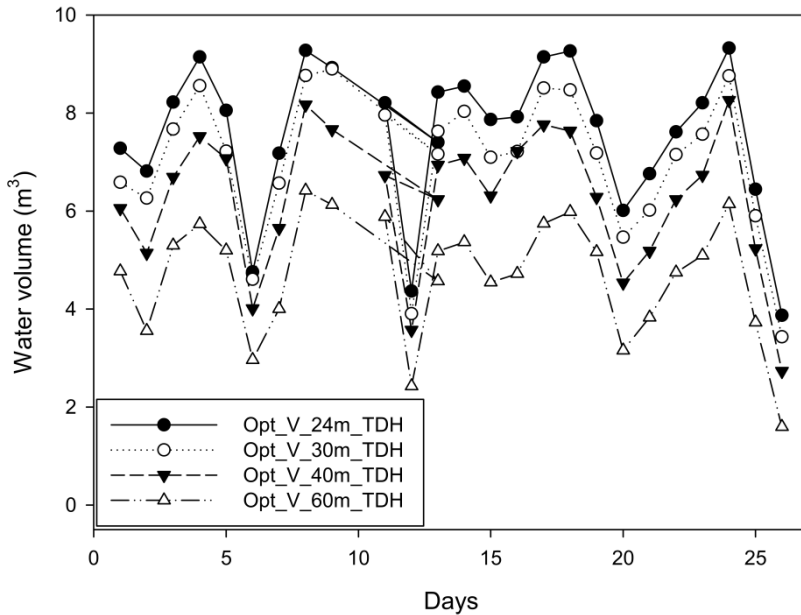

Fig. 13: Water volume for different heads for optimized algorithm

From these figures, we can observe disparity between water volumes. Indeed, irrespective of the situation of the optimized and direct-coupled system, the water flow rate and daily volume decrease as the total discharge head increase which is in accordance with the theoretical results.

The total water volume for the considered month is in the range of 120 m³ and 200 m³ for the optimized system, while it is in the range of 12 m³ and 43 m³ for the direct-coupled system. The daily mean water volume is in the range of 4 m³ and 8 m³ for the optimized system, while it is in the range of 0.5 m³ and 1.7 m³ for the direct-coupled system.

These two parameters are linear functions of total heads as shown in figures 14 and 15.

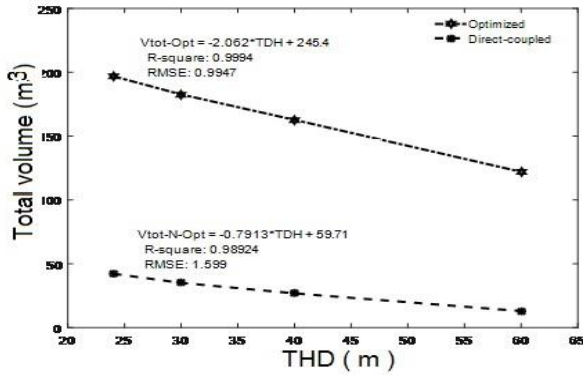

Fig. 14: Monthly total water volume for different heads for direct-coupled and optimized algorithm

Fig 15: Daily mean water volume for different heads for direct-coupled and optimized algorithm

The disparity between optimized and direct-coupled systems is more visible in this above figures. For the considered total discharge heads, this disparity can be accessed for each day as the difference between the water volume collected from the optimized system and the one collected from the direct-coupled system as observed from Figures 16 to 19.

From these figures, it is seen that the daily water volumes provided by the direct-coupled system are very little compare to those provided by the optimized system. This show the effectiveness of the optimization action on the flow delivered by the pump.

The power converter with its MPPT control thus plays a fundamental role in optimal used of the photovoltaic water pumping system to provide water to populations especially those in remote area.

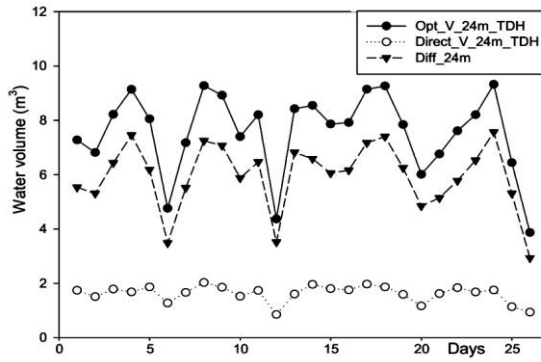

Fig. 16: Daily water volume for 24 m head for direct-coupled and optimized algorithm and their disparity

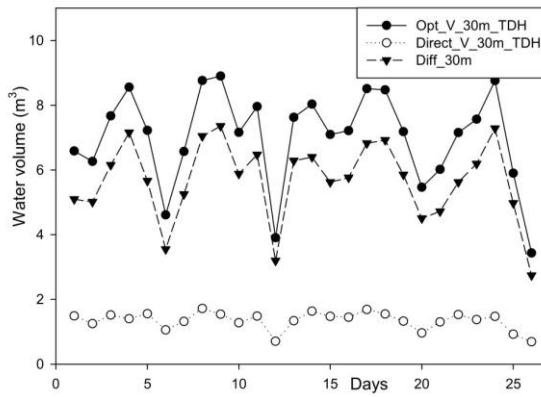

Fig. 17: Daily water volume for 30 m head for direct-coupled and optimized algorithm and their disparity

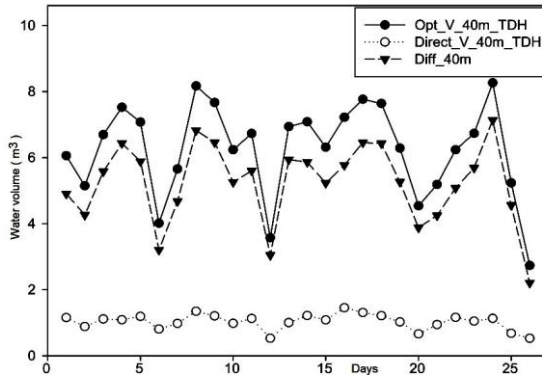

Fig. 18: Daily water volume for 40 m head for direct-coupled and optimized algorithm and their disparity

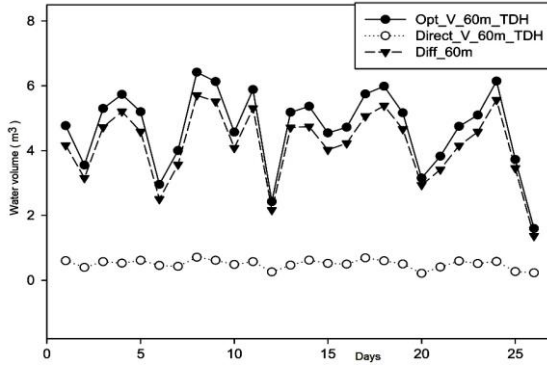

Fig. 19: Daily water volume for 60 m head for direct-coupled and optimized algorithm and their disparity

5. CONCLUSION

This work is focused on prediction of the performance of a photovoltaic water pumping system based on simulation using on field meteorological data. The main objective is to demonstrate relevance of the incremental MPPT algorithms compared to the direct coupled systems for PV water pumping into a specific weather conditions of the Sudanno sahelian zones of Cameroon.

We have modeled a Lorentz PS20-HR04-MPPT pump with a maximum power of 240 W, associated to a DC/DC power converter control with the MPPT Conductance Incrementation algorithm in the Matlab/Simulink platforms.

The effectiveness of the optimized system compare to the direct-coupled system have been shown. For the considered water pumping system, monthly simulations predictions range of 122 m³ to 200 m³ for the total heads in the range of 60 m to 24 m with optimization and in the range of 12 m³ to 43 m³ for the same range of total heads without optimization.

The daily mean water volume were also predicted to be in the range of 4 m³ and 8 m³ for the optimized system, while it was in the range of 0.5 m³ and 1.7 m³ for the non-optimized system during the month.

This study at the end shows the benefit of using incremental conductance MPPT for water pumping systems in the rural area since it provide a high quantity of water compare to direct-coupled systems.

NOMENCLATURE

I_{pv} , Current supplied by the PV generator, A	V_{pv} , Voltage at the terminals of the PV generator, V
n_{cell} , Number of cells in series	k : Boltzmann Constant [8.65x10 ⁵ eV/K = 1.381 x 10 ²³ J/K]
V_{th} , Thermal voltage [23 mV at 300 K for one cell]	T^c : Cell Temperature, K
T_a : Ambient temperature, K	I_{sat} is the dark current, A
T_{NOCT} : Nominal operating cell temperature	R_p , Shunt resistance, Ω
R_s , Serie resistance, Ω	G_0 is irradiance at STC conditions, 1000 W/m ²
I_{ph} is the photocurrent related to the illumination level, A	

G : solar irradiance, W/m ²	K ₁ : Current temperature coefficient, %/°C
I _{ph,T₀} is the short circuit current given by manufacturer, A	α , duty cycle
η : pump efficiency	P _{el} : Electric power, W
T _{on} : Time period when the switch is closed	T _{off} : Time period when the switch is opened
PVWPS: Photovoltaic water pumping system	MPP: Maximum power point
TDH: Total discharge head, m	Q: Water flow rate, m ³ /h
PV: Photovoltaic	DC: Direct current

REFERENCES

- [1] E.L. Molua, *An empirical assessment of the impact of climate change on smallholder agriculture in Cameroon*, Global and Planetary Change, Vol. 67, N°3/4, pp. 205 - 208, 2009.
- [2] M.F. Fonteh, *An assessment of impacts of climate change on available water resources and security in Cameroon*, Journal of the Cameroon Academy of Sciences, Vol. 11, N°2/3, 2013.
- [3] L. Fonjong and V. Fokum, *Water Crisis and Options for Effective Water Provision in Urban and Peri-Urban Areas in Cameroon*, Society & Natural Resources, Vol. 30, N°3, pp. 488 – 505, 2017.
- [4] T.J. Gorham, J. Yoo, R. Garabed, A. Mouhaman and J. Lee, *Water Access, Sanitation, and Hygiene Conditions and Health Outcomes among Two Settlement Types in Rural Far North Cameroon*. International Journal of Environment Research Public Health, Vol. 14, N°4, 2017. doi:10.3390/ijerph14040441
- [5] A.M. MacDonald, HC Bonsor, BEO Dochartaigh and R.G. Taylor, *Quantitative maps of groundwater resources in Africa*. Environment Resesearch Letters, Vol. 7, N°3, 2012. doi:10.1088/1748-9326/7/2/024009
- [6] AE Cheo, Hans-Jürgen Voigt and F. Wendland, *Modeling groundwater recharge through rainfall in the Far-North region of Cameroon*. Groundwater for Sustainable Development. Vol. 5, pp. 118 – 130, 2017.
- [7] A. Barbose, NR Darghouth, S. Weaver, D. Feldman, R. Margolis and R. Wiser, *Tracking US photovoltaic system prices 1998–2012: a rapidly changing market*. Progress in Photovoltaic: Research Application, Vol. 23, N°6, pp. 692 - 704, 2014. DOI: 10.1002/pip.2482.
- [8] International Energy Agency, *Technology Roadmap Solar Photovoltaic Energy*, 2014 edition
- [9] IRENA. *Solar photovoltaic's* . Vol. 1: Power Sector Issue 4/5.
- [10] I. Yahyaoui, *Specifications of Photovoltaic Pumping Systems in Agriculture*, Elsevier 2017, ISBN: 978-0-12-812039-2
- [11] TB Johansson, H. Kelly, RKN Amulya and R.H. Williams, *Renewable energy: sources for fuels and electricity*, Island Press. 1992., ISBN 1-55963-139-2.
- [12] N. Femia, G. Petrone, G., Spagnuolo and M. Vitelli, *Optimization of perturb and observe maximum power point tracking method*. Power Electronics, IEEE Transactions, Vol. 20, pp. 963 - 973, 2005.

- [13] K. Padmavathi and S.A. Daniel, 'Studies on installing solar water pumps in domestic urban sector, Sustainable Cities and Society, Vol. 1, pp. 135 - 141, 2011.
- [14] R. Chenni, M. Makhoulouf, T. Kerbache, and A. Bouzid, *A detailed modeling method for photovoltaic cells*, Energy, Vol. 32, pp. 1724 - 1730, 2007.
- [15] A. Oi, *Design and simulation of photovoltaic water pumping system*, Doctoral dissertation, California Polytechnic State University, San Luis Obispo, 2005.
- [16] A. Salas, V.E. Olias, A. Barrado and A. Lazaro, *Review of the maximum power point tracking algorithms for stand-alone photovoltaic systems*. Solar energy materials and solar cells, Vol. 90, pp. 1555 - 1578, 2006.
- [17] A. Daoud and A. Midoun, *Maximum power point tracking techniques for solar water pumping systems*, Revue des Energies Renouvelables, Vol. 13, N°3, pp. 497 – 507, 2010.
- [18] HP Desai, Ranjan Maheshwari, NS Shambhu V. Shah, *Maximum Power Extraction from Photovoltaic Power Generator with Adaptive MPP Tracker*. Applied Solar Energy, Vol. 46, N°4, pp. 251 – 257, 2010.
- [19] DA Bouden, H. Guza, H. Benis, *Modelling and simulation of photovoltaic pumping system optimized*. Recent Researches in Energy, Environment and Sustainable Development, 2012.
- [20] D. Rekioua and E. Matagne, *Optimization of Photovoltaic Power Systems Modelization*, Simulation and Control. Springer-Verlag London Limited 2012.
- [21] BH Mouna and Sbita Lassaâd. *A Maximum Power Tracking Algorithm Based on Photovoltaic Current Control for Matching Loads to a Photovoltaic Generator*. Applied Solar Energy, Vol. 48, N°4, pp. 238 – 244, 2012.
- [22] MK Gupta and J. Rohit, *MPPT Simulation with DC Submersible Solar Pump using Output Sensing Direct Control Method and Cuk Converter*. International Journal of Renewable Energy Research, Vol. 3, N°1, 2013.
- [23] B. Subudhi, *A Comparative Study on Maximum Power Point Tracking Techniques for Photovoltaic Power Systems*, IEEE Transactions on Sustainable Energy, Vol. 4, 2013.
- [24] FA Aashoor, *Maximum power point tracking techniques for photovoltaic water pumping system*' [A thesis submitted for the degree of Doctor of Philosophy]. University of Bath. May 2015.
- [25] SL Sumathi, KP Ashok and Surekha. *Solar PV and Wind Energy Conversion Systems: An Introduction to Theory, Modeling with Matlab/Simulink, and the Role of Soft Computing Techniques in Wind Energy Conversion Systems*, Springer International Publishing Switzerland. 2015.
- [26] S. Lyden and ME Haque, *Maximum Power Point Tracking techniques for photovoltaic systems: A comprehensive review and comparative analysis*. Renewable and Sustainable Energy Reviews, Vol. 52, pp. 1504 - 1518, 2015.
- [27] B. Pakkiraiah and GD Sukumar, *Research Survey on Various MPPT Performance Issues to Improve the Solar PV System Efficiency*. Journal of Solar Energy, Article ID 8012432, 20 p., 2016.

- [28] O. Boukli-Hacene, *Conception et Réalisation d'un Générateur Photovoltaïque Muni d'une Commande MPPT pour une Meilleure Gestion Energétique*. [Mémoire de Magister]. Université Abou Bakr Belkaid – 171 p., Tlemcen. 2011.
- [29] N. Aouchiche, MS Aït Cheikh and A. Malek, *Poursuite du point de puissance maximale d'un système photovoltaïque par les méthodes de l'incrémentation de conductance et la perturbation & observation*, Revue des Energies Renouvelables., Vol. 16, N°3, pp. 485 – 498, 2013.
- [30] A. Shukla, A. Kumar, A. Agarwal, et al. *Maximum Power Point Tracking Simulation based on Perturb and Observe Algorithm for PV array Using Boost Converter*. American International Journal of Research in Science, Technology, Engineering & Mathematics, Vol. 10, N°2, pp. 133 - 137, 2015.
- [31] EF Dassou, A. Ombolo and S. Chouto, et al. *Trends and Geostatistical Interpolation of Spatio-Temporal Variability of Precipitation in Northern Cameroon*. American Journal of Climate Change. Vol. 5, pp. 229 - 244, 2016.. <http://dx.doi.org/10.4236/ajcc.2016.52020>
- [32] Z. Aretouyap, P. Njandjock Nouck, D. Bisso, et al. *Climate Variability and Its Possible Interactions with Water Resources in Central Africa*. Journal of Applied Sciences, Vol. 14, pp. 2219 - 2233, 2014.
- [33] D. Njomo, *Les solutions solaires aux besoins énergétiques prioritaires des populations rurales des pays en développement*. Revue de l'énergie, Vol. 39, pp. 498 – 503, 1988.
- [34] S. Madougou, M. Kaka and G. Sissoko, *Photovoltaic Water Pumping System in Niger*. Application of Solar Energy intech 2013. <http://dx.doi.org/10.5772/54790>.
- [35] M. EL-Shimy, *Sizing optimisation of stand-alone photovoltaic generators for irrigation water pumping systems*, International Journal of Sustainable Energy. 2012. Doi:10.1080/14786451.2012.697463.
- [36] A. Kabade, Abha Rajoriya and UC. Chaubey, *'Solar Pump Application in Rural Water Supply: A Case Study from Ethiopia*, International Journal of Energy Engineering (IJEE), Vo. 3, pp. 176 - 182, 2013.
- [37] B. Bouzidi, *New sizing method of PV water pumping systems*, Sustainable Energy Technologies and Assessments, Vol. 4, pp. 1 – 10, 2013.
- [38] Z. Muluken, T. Tadiwos and A. Aman, *Optimal Sizing of Solar Water Pumping System for Small Scale Irrigation: Case Study of Dangila*. International Journal of Renewable and Sustainable Energy. Vol. 2014, N°5, pp. 99 - 107, 2014. doi: 10.11648/j.ijrse.20140305.13.
- [39] I. Odeh, YG Yohanis and B. Norton, *Influence of pumping head, insolation and PV array size on PV water pumping system performance*. Solar Energy, Vol. 80, pp. 51 – 64, 2006.
- [40] J.K. Kaldellis, D. Zafirakis and E. Kondili, *Optimum sizing of photovoltaic-energy storage systems for autonomous small islands*. International Journal of Electrical Power & Energy Systems, Vol. 32, pp. 24 - 36, 2010.
- [41] I. Yahyaoui, M. Ammous, and F. Tadeo, *Algorithm for Optimum Sizing of a Photovoltaic Water Pumping System*, International Journal of Computer Applications, Vol. 111, pp. 21 - 28, 2015.

- [42] R. López-Luque, J. Reca and J. Martínez, '*Optimal design of a standalone direct pumping photovoltaic system for deficit irrigation of olive orchards*, Applied Energy, Vol. 149, pp. 13 - 23, 2015.
- [43] G M. Balato, G. Graditi, C. Landi, M. Luiso, and M. Vitelli, *Fast Hybrid MPPT Technique for Photovoltaic Applications: numerical and experimental validation*, Advances in Power Electronics, 2014.
- [44] L. Yahyaoui, M. Chaabene, and F. Tadeo, *A fuzzy based energy management for a photovoltaic pumping plant for tomatoes irrigation*. In Renewable Energy Congress (IREC), 5th International, IEEE, 2014.
- [45] P. Trinuruk, S. Chumnong and C. Dhirayut, *Estimating operating cell temperature of BIPV modules in Thailand*, Renewable Energy, Vol. 34, pp. 2515 – 2523, 2009.
- [46] B. Mesude, C. Yosoon and RS Jeffrey, *Temperature Dependent Power Modeling of Photovoltaics*, Energy Procedia Vol. 57, pp. 745 – 754, 2014.
- [47] M. D’Orazio, C. Di Perna and E. Di Giuseppe. *Experimental operating cell temperature assessment of BIPV with different installation configurations on roofs under Mediterranean climate*. Renewable Energy, Vol. 68, pp. 378 - 396, 2014.