

Solar powered cars - The future challenges

R. Taleb ¹, H. Saidi ^{1,2*} and F. Chabni ¹

¹ Laboratoire Génie Electrique et Energies Renouvelables, 'LGEER'
Electrical Engineering Department, Hassiba Benbouali University, Chlef, Algeria

² Laboratoire d'Electronique de Puissance d'Energie Solaire et d'Automatique
Electronic Engineering Department, USTO-MB University, Oran, Algeria

(reçu le 10 Septembre 2017 - accepté le 30 Septembre 2017)

Abstract - *We hear a lot in the media about the solar car, and that it would be the future car. We see also several examples of this kind in various parts of the world. In this work we would try to do a study which will respond to this question: whether is there currently a solar car, which will be an alternative to cars working with fossil fuel? To get an answer to this question we have to examine some manufactured models and analyze their various data, by studying each element of the vehicle. In second step and in order to confirm what we have concluded, we have to manufacture our car and conduct various tests.*

Résumé - *Nous entendons souvent parler des voitures solaires dans les médias et elles sont souvent décrites comme étant les voitures du futur. Nous observons de nombreux exemples de ce genre à travers le monde. Dans cet article nous tentons de faire une étude qui répondra à la question: Y-a-t-il une voiture solaire capable de constituer une alternative aux voitures roulant aux carburants fossiles? Pour y répondre, nous devons examiner les modèles de quelques fabricants en analysant les données qui les concernent et en étudiant chaque élément du véhicule. Dans un deuxième temps, afin de confirmer nos conclusions, nous devons réaliser notre voiture et effectuer des tests.*

Keywords: Solar vehicle - Fossil fuel - Future challenges - Solar panels.

1. INTRODUCTION

The solar or electric vehicle is considered as a future car according to the view of many people because it resolved the problem of energy and pollution [1-4]. But this vehicle must keep its place between the current vehicle in term of speed, performance and power.

Technically, to provide these requirements is not possible for this type of cars, for several technical problems [5-7]. The most important problem is the type of solar panels and its profitability on one hand. In other hand we must care to how to store energy, the amount of energy stored and time required for charging.

In the beginning we will demonstrate the vehicle, the total solar energy which could be provided by the panels and the location of panels on the vehicle.

We will then expose some models and the required energy, where we take into account the amount of energy stored and engine type, according to the used batteries, cost and weight of the car.

We also conducted an experience about the charging time of batteries, using the panels located on the vehicle. In the latter we did practical experiences on the factory models to get a final result.

* hem.saidi@gmail.com

2. STUDY OF THE SOURCE OF ENERGY IN THE SOLAR VEHICLE

Solar panels are the only source of energy, which make working the various components of the vehicle.

Figure 1 represents the location of the panels on the roof of the vehicle.

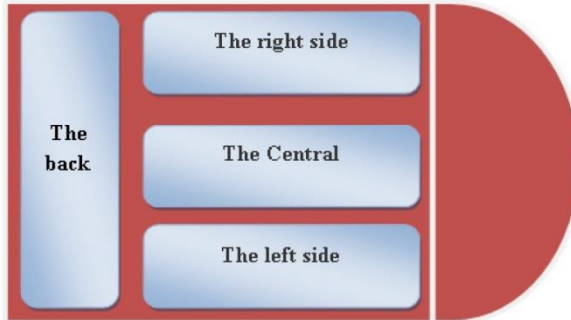

Fig. 1: Arrangement of the solar panels on the roof of the vehicle

According to the International Automobile Federation the total superficies of the solar car is 12 m², the solar panels types used in the most cars are from Amorve 7 % yield. The nature saves for each one meter square 1000 W of electricity. Therefore, the total production of the energy theoretically is:

$$\text{The total production} = 7\% \times 1000 \times 12 = 840 \text{ Watts}$$

But in the field things are different:

1. To get 7% yield from the panels, it should be that sun rays have to be vertical on the panels, which is impossible for the car, thus decrease the energetic yield according the equation (1).

2. The space of panels reserved on the car is between 70% to 90% from the real size, this gives a lost energy from the total.

3. The repositioning solar panels on the car's roof (the smooth surface reduces wind resistance and raises the movement's speed), this positioning doesn't allow to the panels to be in good position in front of the sun, that's why a part of these panels don't catch sun rays according to the traffic's direction.

If the traffic's direction from the South to the North, 80% to 95% from the panels will be in front of the sun (for the population of the northern half and vice versa).

If the traffic's direction from the East to the West 60% to 70% from the panels will be in front of the sun. The shadow of trees, buildings and other cars in the traffic affects the right function of the panels.

To prove what we said, we choose a race course for the solar cars in Australia. It is impossible to get the whole energy produced, so for ensuring good function of the car, must be each part of the solar panels to be independent in its work.

Which is not connected in terms of operation or storage because the lack of energy produced by the cell affects the overall work of the panels and reduces the overall output of the energy. All this according the connection between the solar panels, a sequence or a branch.





3. STUDY OF SOME MANUFACTURED MODELS

We call a solar car if it works directly by solar energy, its battery has to be charged by the solar panels on its board. In this work we will try to show how the function of the solar car is.

3.1 Do the cars operated directly by solar energy?

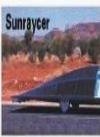
Table 1 shows some of the completed car models.

Table 1: Some of the completed car models

	year	car	Team	Speed (km/h)	Performances
	1987	Sun rayer	General Motor Corporation	66,90	Weight =265 kg, 8000 cellule solare, 1.2kw
		Sub chase	Ford Australia	44,48	Weight = 320kg, 1.5kw
	1990	Spirit of Biel	Eng College of Biel (Suisse)	42,93	Weight = 300kg
		Spirit of Biel	Eng College of Biel	65,18	Battery on lithium =3.7kw
	1993	Dream	Honda Corporation	54,67	Weight = 300kg, Nickel-Metal Hydrid (NiMH)
		Sunrunner	Michigan University (USA)	52,52	Weight = 280kg, 3.8kw
	1993	Dream	Honda Corporation	84,96	Weight = 300kg, 6kw
		Spirit of Biel	Eng College of Biel	78,27	6kw
	1999	Son of Sun	Kyocera Corporation(japon)	70,76	Weight = 260kg, 3.7kw
		Dream	Honda Corporation	94,21	Motor 26kw
	1999	Schooler	Eng College of Biel	86	Weight =300kg, 2.5kw
		Aisol III	Aisin Seiki Co (japon)	80,7	Weight = 260kg, 11kw
	2001	Aurora	Aurora (Australie)	72,96	Battery on lithium de 3.8 kw, Weight = 300 kg
		Nuna I	Alapha Centauri (Hollande)	91,81	Weight = 350kg, 2.3kw
	2003	Aurora	Aurora	90,26	Weight = 250kg, 7kw
		Nuna II	Nuon Solar team	97,02	Weight = 320kg, 9kw
	2005	Aurora	Aurora	91,90	15kw
	2007	Nuna III	Nuon Solar team	102,75	

General Notes

4. The source of energy that cars need for its functioning it's not from the solar panels.

5. Regarding to the weight and the speed of the car, then the following representation (figure 2) [8, 9].

We found that getting the same speed with the same power by taking in consideration the type of solar panels plus the total weight of the car impossible that the car gets its energy from the solar panels but it gets it from the battery.

3.2 Can the solar panels on the car board charge the batteries?

In this study we will divide the work into two parts:

1. We will try to find the space of solar panels needed to charge the batteries for each type of car.
2. Battery charging time.

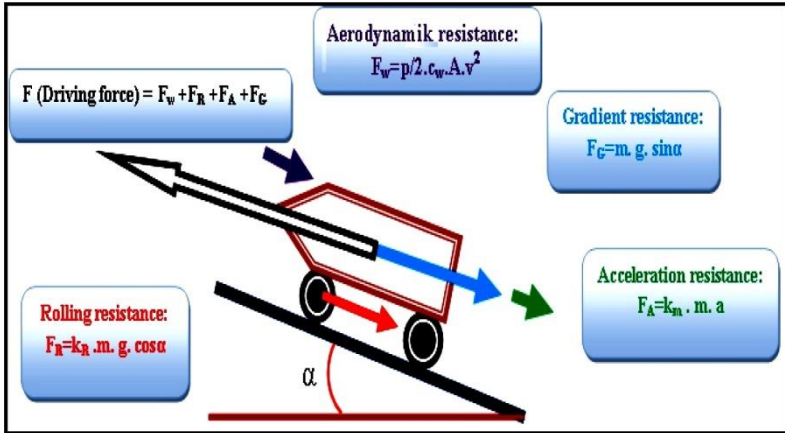

Fig. 2: Representation of all forces acting on EV

The needed space to charge the battery by each type: The following table shows this. In the calculation we did not take in consideration the lack of yield as a result from the non-directing of the panels and the allocated space for them.

Table 2: Needed space to charge the battery

Car	The space of the necessary panels according to the type used	performances
Sun racer	20 m ²	Weight = 265 kg, 8000cillele solar, 1.2kw
Sub chase	25 m ²	Weight = 320kg, 1.5kw
Spirit of Biel	60 m ²	Weight = 300kg
Spirit of Biel	61 m ²	Batterie on lithium = 3.7kw
Dream	67 m ²	Poids = 300kg, Nickel-Metal Hydrid (NiMH)
Sun runner	63 m ²	Weight = 280kg, 3.8kw
Dream	100 m ²	300kg, 6kw
Spirit of Biel	100 m ²	6kw
Son of Sun	61 m ²	Weight = 260kg, 3.7kw
Dream	433 m ²	Motor 26kw
Schooler	42 m ²	Weight = 300kg, 2.5kw
Aisol III	183 m ²	Weight = 260kg, 11kw
Aurora	64 m ²	Battery on lithium of 3.8kw, Weight = 300 kg
Nuna I	38 m ²	Weight = 350kg, 2.3kw
Aurora	117 m ²	Weight = 250kg, 7kw
Nuna II	150 m ²	Weight = 320kg, 9kw
Aurora	250 m ²	15kw

The required space of the panels is a large area according to all types of cars, for this it is impossible to charge the batteries. In order to prove what we said, we have done a circuit charging inside the car representing by the figure 3 [10].

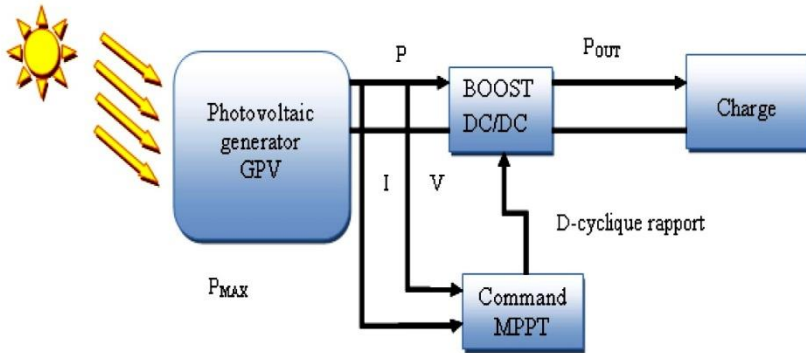

Fig. 3: Representation of the circuit electronic

The results were as follows (figures 4, 5 and 6).

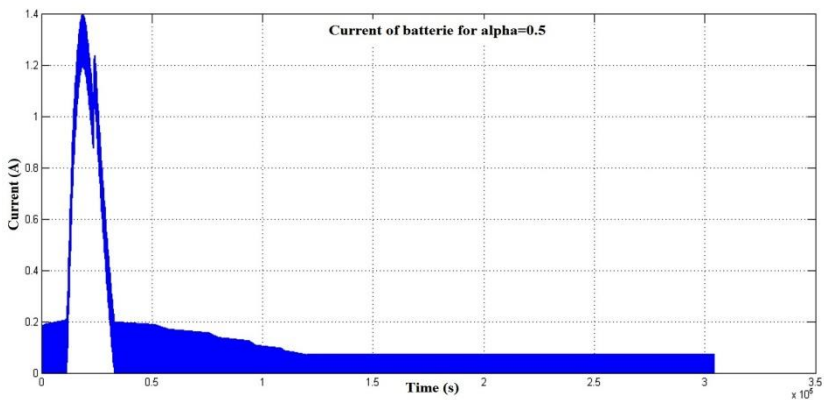

Fig. 4: Simulations show the courant of the battery for duty cycle alpha = 0.5

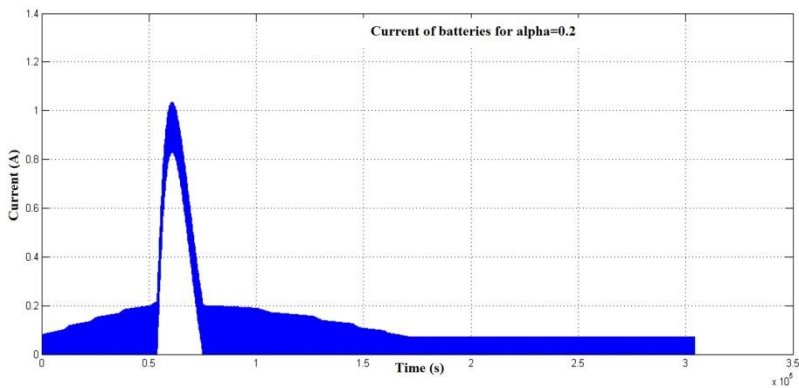

Fig. 5: Simulations show the courant of the battery for duty cycle alpha = 0.2

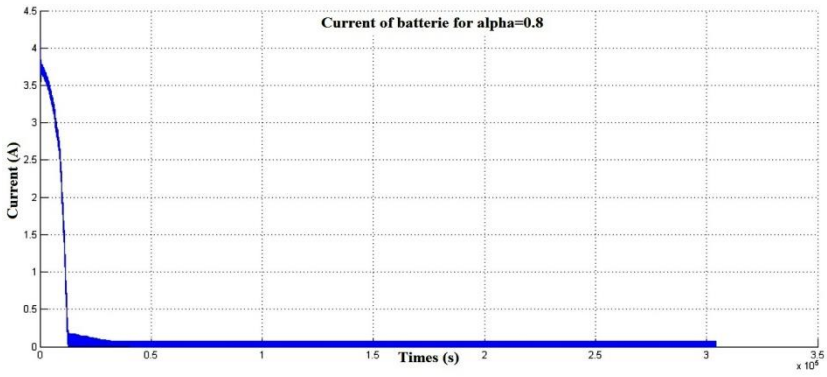

Fig. 6: Simulations show the courant of the batterie for duty cycle $\alpha = 0.8$

We note that in all cases the charging time is more than 8 hours, so it is impossible to charge the batteries with solar panels on the car.

To prove that we made some tests on the two cars which we had made, as they are showing below (figures 7 and 8). As we expected, it is impossible for this type of car to operate depending on the energy delivered by solar panels.



Fig. 7: Photo one of the vehicle manufactured



Fig. 8: Photo two of the vehicle manufactured

4. PROPOSED SOLUTIONS

1. We have converted these cars into electric cars that are powered by solar energy.
2. We have manufactured a moving charging unit according to the figures 9 and 10, which has the ability to track the movement of the sun to increase the yield of solar panels



Fig. 9: Solar charging unit manufacturer (the front face)



Fig. 10: Solar charging unit manufacturer (back flip)

Through these experiences we got good results. Whereas the shipping time is about 5 hours, and to solve the charging time problem, we have changed the batteries directly and therefore the charging time for the user is almost negligible.

5. CONCLUSION

The dream of human being is to reach a clean and permanent technology especially in transportation's field. But the progressing in technology now days doesn't allow for reaching this ambition desired by us, in order to keep the comfort of transportation means.

For this we have to deal with what the high technique of technology give us, notably the efficacy of the solar panels. Whereas we show the main problem, also the way and the period of energy charging, that is why it had to find new techniques to keep the consequences of the new and old vehicles.

As a result for that, we did separate the solar panels from the vehicle in order to transform the vehicle to an electric vehicle be charged by stable and mobile unities, these unities work with solar energy, in order to earn the long time of charging the batteries by just changing them with others are already charged.

The following research will be concentrate to test the safety of the changing batteries by an electronic tester.

REFERENCES

- [1] G. Oriti, A.L. Julian and, N.J. Peck, '*Power Electronics Based Energy Management System with Storage*', IEEE Transactions on Power Electronics, vol. 31, N°1, pp. 452 - 460, January 2016.
- [2] H. Cheng, X. Gong, Y.F. Hu, Q.F. Liu, B.Z. Gao and H.Y. Guo, '*Automotive Control: the State of the Art and Perspective*', Acta Automatica Sinica, Vol. 39, N°4, pp. 322 - 346, 2013.
- [3] T. Wei, T. Kim, S. Park and Q. Zhu, '*Battery Management and Application for Energy-Efficient Buildings*', 51st ACM/EDAC/IEEE Design Automation Conference (DAC), pp. 1-6, San Francisco, USA, 1-5 June, 2014.
- [4] D. Ganesh, S. Moorthi and H. Sudheer, '*A Voltage Controller in Photo-Voltaic System with Battery Storage for Stand-Alone Applications*', International Journal of Power Electronics and Drive System, IJPEDS, Vol. 2, N°1, pp. 9 - 18, 2012.
- [5] M. Grosso, D. Lena, A. Bocca, A. Macii and S. Rinaudo, '*Energy-Efficient Battery Charging in Electric Vehicles with Solar Panels*', 2nd International Forum on Research and Technologies for Society and Industry Leveraging a better tomorrow, RTSI, Bologna, pp. 1 - 5, 2016.
- [6] G.R.C. Mouli, M. Leendertse, V. Prasanth, P. Bauer, S. Silvester, S. van de Geer and M. Zeman, '*Economic and CO₂ Emission Benefits of a Solar Powered Electric Vehicle Charging Station for Workplaces in the Netherlands*', IEEE Transportation Electrification Conference and Expo, 'ITEC', Dearborn, MI, pp. 1-7, 2016.
- [7] A. P. Kulkarni and P. Pingle, '*Electric Vehicular Technology Using Natural Resources*', International Conference on Automatic Control and Dynamic Optimization Techniques, ICACDOT, Pune, pp. 483 - 489, 2016.
- [8] H. Saidi, R. Taleb, N. Mansour and A. Midoun, '*DSP Based Space Vector PWM Control for Solar Electric Vehicle*', Revue des Energies Renouvelables, Vol. 19, N°2, pp. 321 - 331, 2016.
- [9] H. Saidi, R. Taleb and A. Midoun, '*Study and Realization of Electro-Solar Vehicle*', International Journal of Electronics Communication and Computer Engineering, IJECCE, Vol. 5, N°3, pp. 696 - 707, 2014.
- [10] H. Saidi, '*Etude et Réalisation d'un Véhicule Solaire*', PhD Thesis, University of Science and Technology of Oran-Mohamed Boudiaf, Algeria, 2016.