

# Study of the absorption refrigerating cycle, $\text{NH}_3\text{-H}_2\text{O}$ coupled with the solar absorption heat transformer, $\text{H}_2\text{O-LiBr}$ by solar data from the City of Oujda (Morocco)

F. Rhayt \*, A. Dezairi, S. Ouaskit,  
H. Loulijat, H. Zerradi and S. Mizani

Condensed Matter Physics Laboratory, Faculty of Science Ben M'sik - Sidi Othman  
B.P 7955, Casablanca, Morocco

(reçu le 10 Juillet 2014 – accepté le 26 Mars 2015)

**Abstract** - A solar refrigerator is made of a solar collector and a refrigeration system. This paper concerns the study of a two-stage vapour absorption cycle (heat transformer and refrigerating cycle) employing the refrigerant absorbent combinations of  $\text{H}_2\text{O-LiBr}$  and  $\text{NH}_3\text{-H}_2\text{O}$  successively. The system consists of coupling the previous absorption cycle so that the first-stage absorber produces heating water to circulate in the generator of the second stage. It is found that the system can be operated at lower hot source temperatures and, thus, it can be supplied either from flat plate collectors.

**Résumé** - Un réfrigérateur solaire est composé d'un capteur solaire et d'un système de réfrigération. Ce papier présente une étude d'une machine frigorifique à absorption ' $\text{NH}_3\text{-H}_2\text{O}$ ' alimentée par un thermo transformateur à absorption ' $\text{H}_2\text{O-LiBr}$ ' de telle manière que l'absorbeur du thermo transformateur produit de la chaleur qui alimentera ensuite le bouilleur de la machine frigorifique. On constate que le système peut fonctionner à basses températures et par conséquent, il peut être fourni soit à partir des capteurs solaires plans.

**Keywords:** Absorption cycle - Solar refrigeration – COP - Heat transformer - Flat plate collector.

## 1. INTRODUCTION

The use of solar energy for cooling offers the advantage of energy availability that is correlated, to some degree, to the demand for cooling. Currently, the most commonly applied method uses a solar collector field to produce a hot fluid, which is used to drive a thermal chiller.

Among the different thermal technologies, single-effect absorption chillers offer readily available commercial equipment and new technological advances [1-4].

Since the demand for refrigeration is generally greatest at the time of maximum solar radiation, the seasonal variation of terrestrial insolation meshes very well with the needs of refrigeration to provide human comfort and food preservation by the use of high concentrating solar collectors. Solar energy can be converted in a central power plant or in individual houses to electrical energy, which can be utilized to operate a vapor-compression refrigeration cycle to produce cooling.

However, until now, the technology for the conversion from solar energy to electrical energy to cooling load has not been accomplished economically. We are more likely to rely on the more sophisticated and less efficient method of absorption refrigeration for cooling purposes. Flat-plate solar collectors are commonly used in solar space heating. It is economically sound when the same collector is used for both spaces heating and cooling. However, because of the relatively low temperatures attainable

---

\* rhaytfathi@yahoo.fr

when flat-plate collectors are used, only a few practical methods are available in flat-plate solar-operated cooling processes. One of the most promising schemes is the utilization of an absorption refrigeration cycle with solar energy serving as the source of heat to operate the generator.

Air conditioning is one of the most widely researched applications, resulting from the potential reduction of carbon emission and the reduction of electricity consumption peaks. Currently, the lithium bromide–water solution is most commonly used as the working fluid in absorption machines. These machines interact with three thermal transport circuits. The hot water circuits (primary, secondary and tertiary) transport heat from the collector field to the chiller refrigerant vapor generator. A hot water storage tank typically serves as a buffer during the day. The heat rejected from the vapor condenser and absorber is sent to the ambient, either atmosphere or ground. Finally, the chiller circuit receives heat from the load or from a chilled water storage tank, which occurs in the machine refrigerant evaporator [5].

This thermal scheme has served to idealize the chiller as a heat pump, operating between three or even four (separating the absorber from the condenser) constant temperature levels. Both internally reversible and irreversible thermodynamic cycle models have been developed. [6] attribute external irreversibility's to heat transfer in the heat exchangers.

The literature offers many contributions with different levels of complexity. [7] offer a review of these models, which allow for performance improvement and optimization of absorption refrigerators, which is not the aim of this paper. Here, optimization of the operation of commercial solar cooling installations is pursued.

In reality and also with models an increase in chiller efficiency is obtained with a generator temperature increase, but this also results in a decrease in solar collector efficiency; thus, there exist an optimum generator temperature. For this, we only cite works on this topic that include solar collectors in the analysis, [8-11], among others.

The application of this kind of models increases in difficulty during operational optimization since some parameters from the machine must be known, e.g., the heat exchanger conductivity  $U_A$  as well as the degree of lumped internal irreversibility's. Another family of predictive models includes the thermodynamic and transport properties of the working solution to develop a thermo fluid model.

Heat and mass transfer can be included to increase the degree of realism, where the simplest model has fixed internal temperatures and equilibrium is assumed at the exit of the thermal components, [6]. For a more realistic model, a large system of nonlinear equations must be solved, and specialized computer codes are required. Much more information regarding the machine is also needed, which is seldom available from manufacturers. As an example, in [12], the effect of the generator temperature is obtained for a variety of cycles, solar collector configurations and solution compositions in a solar cooling layout without a heat storage tank.

A similar study was performed by [13], but again, the optimal hot water temperature was not determined. The main objective here is to obtain an algorithm that yields the optimum instantaneous hot water temperature. Much additional research in solar absorption refrigerators has been conducted through the development of numerical methods [14-20].

The utilisation of solar energy in absorption refrigerating machines is limited by the condition that only heat collected at temperatures greater than a minimum value can be used in the refrigerating machine. Previous work indicated that the optimum temperature of functioning of the absorption machine is of the order of 120 °C. This

requires the use of evacuated solar collectors or concentrators which are expensive and are not available on the market. To resolve this problem we have coupled the absorption refrigerating machine with a solar-driven H<sub>2</sub>O-LiBr absorption heat transformer, which elevates useful heat of solar collector to a higher temperature level.

## 2. ABSORPTION REFRIGERATOR

The absorption refrigerating machine connected by an absorption heat transformer is shown in Fig. 1. An absorption heat transformer its lower parts contain the low-pressure vapour generator and a condenser, while the high-pressure absorber and evaporator are contained in the upper part.

Heat is extracted from solar collectors at temperature  $T_s$  and given to the generator **1** and the evaporator **1**. Then the heat is delivered to the condenser **1** to a cold source at temperature  $T_M$  and in the absorber **1** at temperature  $T_A$ . The heat evolved in the absorber of the absorption heat transformer is utilized in the generator of the absorption refrigerating cycle. The condenser and the absorber of the absorption refrigerating cycle are kept at ambient temperature  $T_M$ .

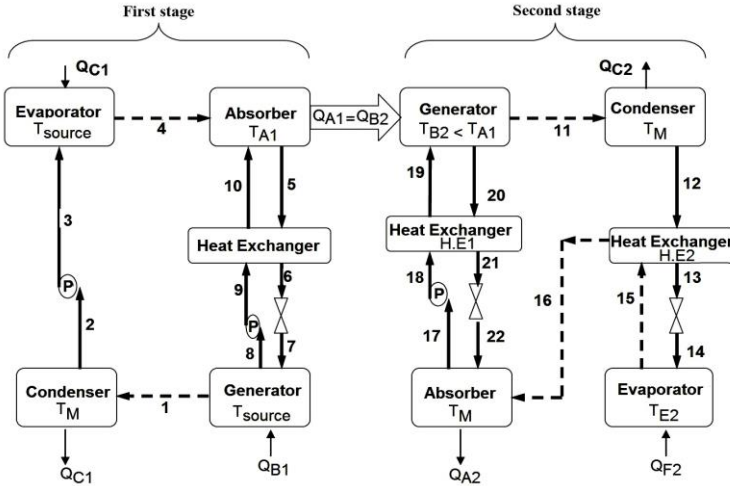

Fig. 1: Diagram of the two-stage machine

## 3. THERMODYNAMIC AND SOLAR SIMULATION

The simulation is based in masse and heat balances for each component of the system, taking into account the real conditions of the machine's functioning. The enthalpy in each point of the cycle of the refrigerating cycle is calculated from the analytic expression of the free energy given by Ziegler [21]:

$$H = G - T \times \left. \frac{\partial G}{\partial T} \right|_P$$

Where  $G$  is the Gibbs free enthalpy.

The equilibrium properties ( $P$ ,  $T$ ,  $X$ ,  $Y$ ) are determined with the experimental correlation of the Gibbs. In the case of the heat transformer, the thermodynamic properties at each point of the cycle have been expressed in the form of state equations

utilizing temperature and mass fraction  $X$  (kg LiBr per kg solution) of the  $H_2O$ -LiBr solution as the independent variables. Pressure, enthalpy of liquid water and of the water vapour, temperature and enthalpy of the  $H_2O$ -LiBr solution are computed using the following state equation forms.

-Water liquid-vapour pressure [22]-

$$\ln P_s = 7.05 - \frac{1596.49}{(T_s + 273.15)} - \frac{104095.5}{(T_s + 273.15)^2}$$

-Water liquid-vapour enthalpy [23]-

$$h_l = 4.199 \times T$$

- $H_2O$ -LiBr solution temperature [24]-

$$T = T_S \times \sum_{n=0}^3 A_n \times X_n + \sum_{n=0}^3 B_n \times X_n$$

- $H_2O$ -LiBr solution temperature [25]-

$$h(T, X) = \sum_{n=0}^4 C_n X_n + T \times \sum_{n=0}^4 D_n X_n + T^2 \times \sum_{n=0}^4 E_n X_n$$

Referring to Fig. 1, the various heat transfer rates are as follows:

$$Q_{B_1} = q_{m_1} \cdot h_1 + q_{m_8} \cdot h_8 - q_{m_7} \cdot h_7$$

$$Q_{C_1} = q_{m_1} \times (h_1 - h_2)$$

$$Q_{E_1} = q_{m_1} \times (h_4 - h_3)$$

$$Q_{A_1} = q_{m_{10}} \cdot h_{10} + q_{m_1} \cdot h_1 - q_{m_5} \cdot h_5$$

$$q_{m_{11}} = \frac{Q_{A_1}}{(h_{11} + D_1 \cdot h_{20} - D_2 \cdot h_{19})}$$

$$\text{Avec, } D_1 = \frac{(Y_{11} - X_{19})}{(X_{19} - X_{20})}$$

$$D_2 = \frac{(Y_{11} - X_{20})}{(X_{19} - X_{20})}$$

$$Q_{B_2} = q_{m_{11}} \cdot h_{10} + q_{m_{20}} \cdot h_1 - q_{m_{19}} \cdot h_{19}$$

$$Q_{C_2} = q_{m_{11}} \cdot (h_{11} - h_{12})$$

$$Q_{E_2} = q_{m_{15}} \cdot (h_{15} - h_{14})$$

$$Q_{A_2} = q_{m_{16}} \cdot h_{16} + q_{m_{22}} \cdot h_{22} - q_{m_{17}} \cdot h_{17}$$

The coefficient of performance, COP, is defined as the ratio of the heat pumped from a low temperature source in the second stage evaporator to the heat input required in the generator and the evaporator of the first stage, i.e.

$$\text{COP} = \frac{Q_{E_2}}{Q_{E_1} + Q_{G_1}}$$

The study of solar installation is based on real meteorological hourly data for July in city Oujda (Morocco) (Fig. 2). Taking into account the temperatures reached by solar

collectors, we have selected the flat plate solar collectors, the efficiency of which is given by Hottel-Whillier [18]:

$$\eta_s = F_b \times \left( \eta_0 - \frac{U (T_g - T_c)}{I_s} \right)$$

$$\text{Where, } F_b = \frac{F_r}{(1 - F_r \cdot \beta)} \quad \beta = \frac{U}{m \cdot C_p} \quad F_r = \frac{1 - \exp(-\beta)}{\beta}$$

with the following characteristics:  $\eta_0 = 0.8$  is the optical efficiency,  $U = 7 \text{ W/m}^2\text{K}$  is the coefficient of thermal losses,  $m = 50 \text{ kg/hm}^2$  is the flow rate by surface unit,  $I_s$  ( $\text{W/m}^2$ ) is the global irradiation of an inclined plane,  $C_p = 4186 \text{ J/kgK}$  is the specific heat of working fluid (water),  $T_g$  is the temperature of heat source and  $T_c$  is the condenser temperature.

First, we have determined the optimum functioning conditions of the installation for a constant global irradiation,  $I_s = 800 \text{ W/m}^2$ , received the solar collectors. Then we have carried out a study at solar thread hour by hour. The solar coefficient of performance COPs is defined as:  $\text{COPs} = \text{COP} \times \eta_s$  where  $\eta_s$  is the efficiency of the solar collector.

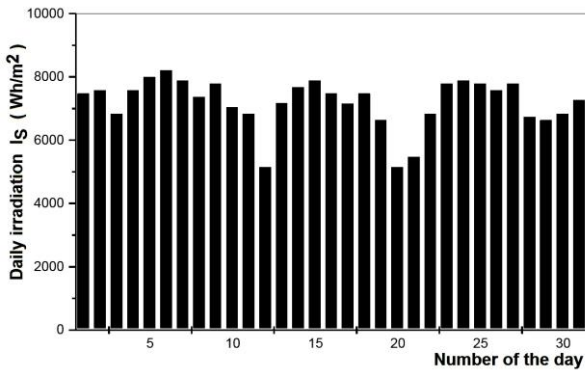

Fig. 2: Daily solar energy in city Oujda (Morocco) for July

## 4. RESULTS AND DISCUSSION

### 4.1 Study at constant irradiation

The two-stage system is supplied by the evaporator and the generator of the first stage. The operating temperature is then  $T_S$ . The coefficient of performance of the two-stage absorption system at a fixed value of evaporator temperature is shown in Fig. 3.

The effect of the hot source temperature on the COP is studied under the following condition: the evaporator and the generator of the first stage are supplied by separate solar collectors. Thus,

$$T_{G_1} = T_{E_1} = T_S$$

A comparative study of single-stage and two-stage minimum functioning temperatures with ambient temperature, at an evaporator temperature of  $-10 \text{ }^\circ\text{C}$ , is shown in Fig. 4.

It is evident that the two-stage cycle starts operating at a considerably lower temperature than the single-stage cycle.

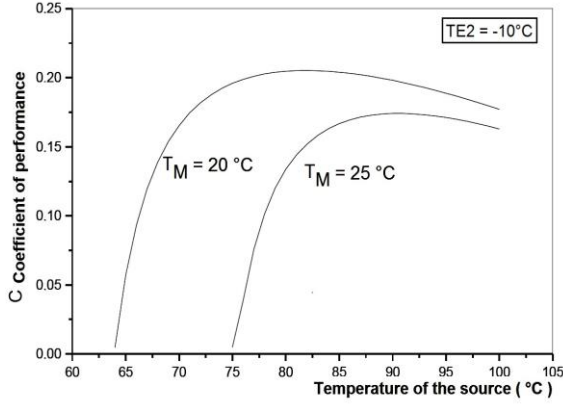

Fig. 3: Effect of hot source temperature on the coefficient of performance

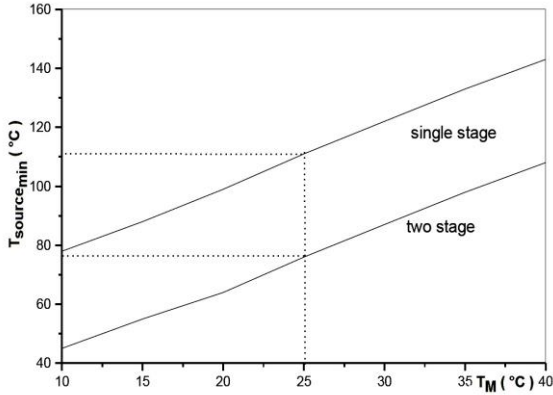

Fig. 4: Effect of the ambient temperature on the required minimum  $T_{source}$

Fig. 5 shows the effect of  $T_S$  on the solar coefficient of performance of the two-stage at the constant global irradiation  $I_s = 800 \text{ W/m}^2$ . The variation of the collector area needed to produce a refrigerating effect of 1 kW is shown in Fig. 6. The characteristics of the functioning point corresponding to the maximum COPs and the minimum area of solar collectors are:

Ambient temperature, $T_M = 20^\circ\text{C}$	Two stage high pressure, $P_{B_2} = 11 \text{ bars}$
Temperature of functioning, $T_S = 84^\circ\text{C}$	Two stage low pressure, $P_{E_2} = 1.7 \text{ bars}$
First stage high pressure, $P_{E_1} = 2.3 \text{ bars}$	First stage low pressure, $P_{B_1} = 1.2 \text{ bars}$
Heat transfer in the two stage generator $B_2$ , $Q_{B_2} = 2.45 \text{ kW}$	Heat transfer in the two stage generator $E_2$ , $Q_{E_2} = 2.45 \text{ kW}$
Heat transfer in the first evaporator $E_1$ , $Q_{E_1} = 3.14 \text{ kW}$	Heat transfer in the first evaporator $B_1$ , $Q_{B_1} = 3 \text{ kW}$
Area solar collector, $S_{cap} = 16.2 \text{ m}^2$	

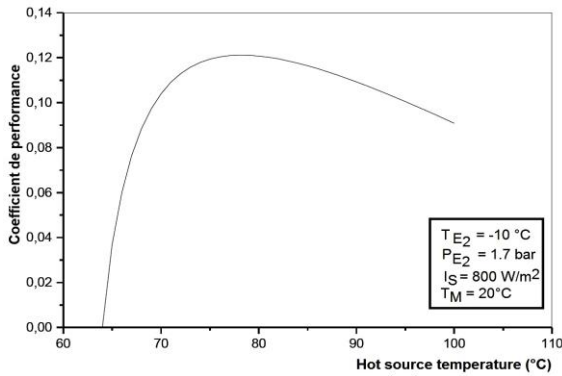

Fig. 5: Effect of hot source temperature on solar coefficient of performance

#### 4.2 Study at solar thread

The variation of a rough refrigerating effect produced at a fixed temperature of  $-10^{\circ}C$  is shown in Fig. 7. It can be seen that the two-stage machine could produce a rough refrigerating power, fairly important while using flat plate collectors, with  $16\text{ m}^2$  of flat plate collectors, the average rough refrigerating effect is  $570\text{ W}$ .

For a clear day, 6 July we have represented in Fig. 8-11. The following parameters as a function of solar time: the solar temperature,  $T_S$ , the solar coefficient, COPs, the efficiency of the flat plate collectors,  $\eta_s$ , and the heat flows  $Q_{E_2}$  and  $Q_{E_2} + Q_{G_1}$ .

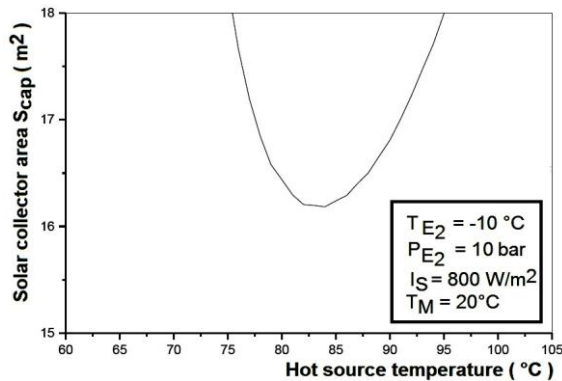

Fig. 6: Effect of hot source temperature on solar collector area needed for the production of 1 kW of refrigeration

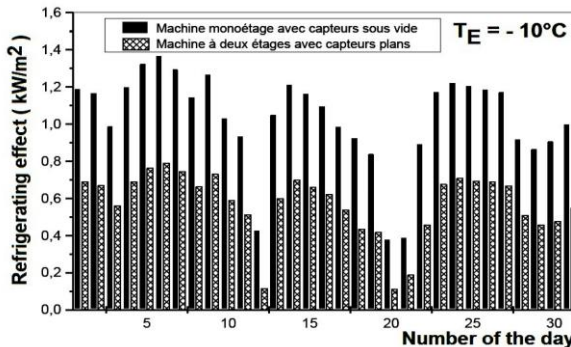

Fig. 7: Daily refrigerating effect for July for a flat plate collector area of  $16.2\text{ m}^2$

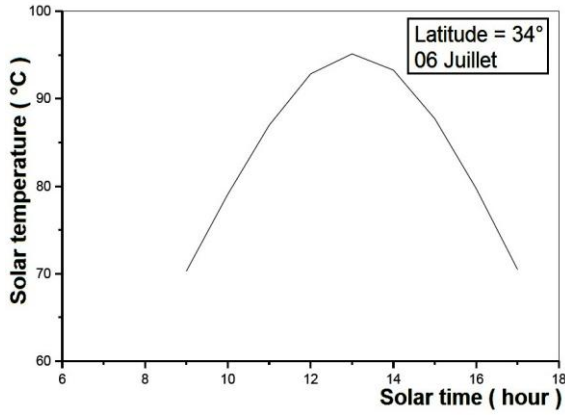

Fig. 8: Evolution of the solar temperature as a function of solar time for 6 July

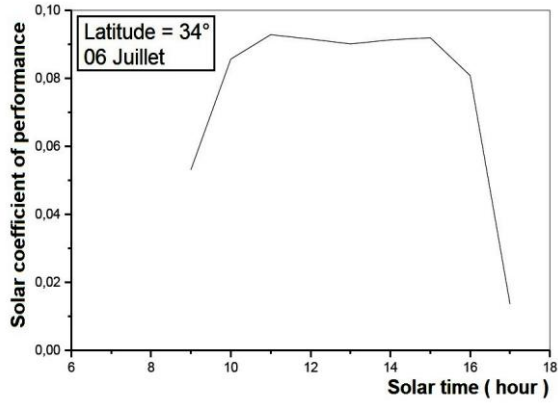

Fig. 9: Evolution of the solar coefficient of performance as a function of solar time for 6 July

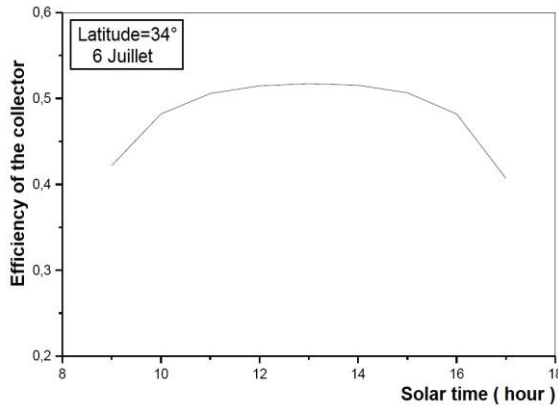

Fig. 10: Evolution of the efficiency of the collector as a function of solar time for 6 July



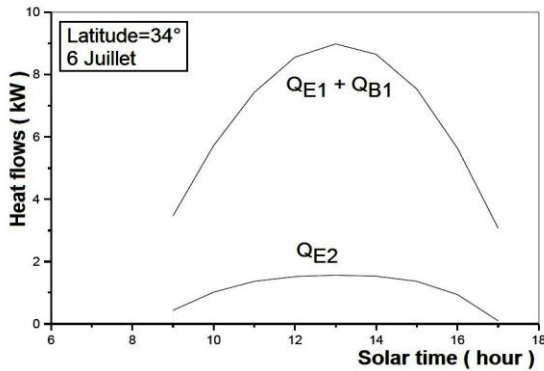

Fig. 11: Evolution of the heat flows as a function of solar time for 6 July

## 5. CONCLUSION

This study shows that the two-stage solar machine can be used to produce cold starting with considerably lower generator temperatures as compared to the single-stage absorption system. Thus, the two-stage cycle can be supplied either with the usual flat plat collector.

## REFERENCE

- [1] G. Grossman, 'Solar-Powered Systems for Cooling, Dehumidification and Air-Conditioning', Solar Energy, Vol. 72, N°1, pp. 53 – 62, 2002.
- [2] H.M. Henning, 'Solar Assisted Air Conditioning of Buildings, - An Overview', Applied Thermal Engineering, Vol. 27, N°10, pp. 1734 - 1749, 2007.
- [3] F. Ziegler, 'State of the Art in Sorption Heat Pumping and Cooling Technologies', International Journal of Refrigeration, Vol. 25, N°4, pp. 450 - 459, 2002.
- [4] X.Q. Zhang, L. Xi, Y. Hou, J. Wang and Z. Xie, 'Experimental Study of Thermo-siphon Generator for Solar Energy LiBr Absorption Refrigerator', Journal of Environment and Engineering, Vol. 5, N°2, pp. 330 - 338, 2010.
- [5] D.W. Sun, I.W. Eames and S. Aphornatana, 'Evaluation of a Novel Combined Ejector-Absorption Refrigeration Cycle1, Computer Simulation', International Journal of Refrigeration, Vol. 19, N°3, pp. 172 - 180, 1996.
- [6] K.E. Herold, R. Radermacher and S.A. Klein, 'Absorption Chillers and Heat Pumps', 350 p., CRC Press, 1996.
- [7] J.M. Gordon and K.C. Ng, 'Cool Thermodynamics', Cambridge Int. Sc. Pub., UK, 2000.
- [8] L. Chen, T. Zheng, F. Sun and C. Wu, 2006. 'Irreversible Four-Temperature Level Absorption Refrigerator'. Solar Energy, Vol. 80, N°3, pp. 347–360, 2006.
- [9] J.V.C. Vargas, M. Sokolov and A. Bejan, 'Thermo-Dynamic Optimization of Solar-Driven Refrigerators', Transactions of the ASME Journal of Solar Energy Engineering Vol. 118, N°2, pp. 8 – 130, 1996.
- [10] C. Wu, L. Chen and F. Sun, 'Optimization of Solar Absorption Refrigerator', Applied Thermal Engineering, Vol. 11, N°2, pp. 203 - 208, 1997.

- [11] N.E. Wijeyesundera, 'An Irreversible-Thermodynamic Model For Solar-Powered Absorption Cooling Systems', Solar Energy, Vol. 68, N°1, pp. 69 – 75, 2000..
- [12] R. Fathi and S. Ouaskit, 'The Optimum Performance of Absorption Cycles with External and Internal Irreversibilities', Moroccan Journal Condensed Matter, Vol. 4, N°1, pp. 104 - 108, 2001.
- [13] D.S. Kim and C.H.M. Machielsen, 'Comparative Study on Water- and Air-Cooled Solar Absorption Cooling Systems', In: Proceedings of EuroSun, ISES Conference, Bologna, Italy, 2002.
- [14] G.S. Kochhar and S. Satcunathan, 'Optimum Operating Conditions of Absorption Refrigeration Systems for Flat Plate Collector Temperatures', In: Journal of Solar Engineering, Proceedings of the Third Annual Conference on System Simulation, Economic Analysis/Solar Heating and Cooling Operational Results, pp. 260 - 267, 1981.
- [15] A. Şencan, K.A. Yakut and S.A. Kalogirou, 'Exergy Analysis of Lithium Bromide/Water Absorption Systems', Renewable Energy, Vol. 30, N°5, pp. 645 – 657, 2005.
- [16] A. Florides, S.A. Kalogirou, S.A. Tassou and L.C. Wrobel, 'Modelling, Simulation and Warming Impact Assessment of a Domestic-Size Absorption Solar Cooling System', Applied Thermal Engineering, Vol. 22, N°12, pp. 1313 - 1325, 2002.
- [17] C. Wu, L. Chen and F. Sun, 'Optimization of Solar Absorption Refrigerator', Applied Thermal Engineering, Vol. 17, N°2, pp. 203 – 208, 1997.
- [18] R. Fathi, C. Guemimi and S. Ouaskit, 'An Irreversible Thermodynamic Model For Solar Absorption Refrigerator', International Journal of Renewable Energy, Vol. 29, N°8, pp. 1349 – 1365, 2004.
- [19] J.P. Praene, O. Marc, F. Lucas and F. Miranville, 'Simulation and Experimental Investigation of Solar Absorption Cooling System in Reunion Island', Applied Energy, Vol. 88, N°3, pp. 831 – 839, 2011.
- [20] Berhane H. Gebreslassie, G. Guillén-Gosálbez, L. Jiménez and D. Boer. 'A Systematic Tool for the Minimization of the Life Cycle Impact of Solar Assisted Absorption Cooling Systems', Energy, Vol. 35, N°9, pp. 3849 – 3862, 2010.
- [21] B. Ziegler and C. Trepp, 'Equation of State for Ammonia-Water Mixtures', International Journal of Refrigeration, Vol. 7, N°2, pp. 101 – 106, 1984.
- [22] ASHRAE, 'Handbook of Fundamentals', 1985.
- [23] J.H. Keenan, F.G. Keyes, P.G. Hill and J.G. Moore, 'Steam Tables, Thermodynamic Properties of Water including Vapour, Liquid and Solid Phases', John Wiley, New York, 1969.
- [24] Scientific Document, 'ASHRAE Handbook and Product, Directory. Tabulation of the Enthalpy-Composition- Temperature Data and Vapour Pressure Chart for Aqueous LiBr Solutions', 1977.
- [25] D.A. Kouremenos, K.A. Antonopoulos and E. Rogdakis, 'Hour Simulation of Solar H<sub>2</sub>O-LiBr Absorption Heat Transformers in Athens', Solar and Wind Technology, Vol. 7, N°2-3, pp. 111 – 118, 1990.