

Neural network and fuzzy logic to track maximum power point in photovoltaic system

N. Drir^{1*}, L. Barazane² et M. Loudini^{2†}

¹ Faculté d'Electronique et d'Informatique
Université des Sciences et de la Technologie Houari Boumediene, USTHB
B.P. 32, El Alia, Bab Ezzouar, Algiers, Algeria

² Laboratoire de Communication dans les Systèmes Informatiques, LCSI
Ecole Nationale Supérieure d'Informatique, Oued Smar, Algiers, Algeria

(reçu le 10 Janvier 2013 – accepté le 29 Juin 2014)

Abstract - *The output characteristics of photovoltaic systems are nonlinear and change with variations of temperature and irradiation, so we need a controller named maximum power point tracker MPPT to extract the maximum power at the terminal of photovoltaic generator. This study explores two intelligent controller based on a neural networks and fuzzy logic to track this point. These both controllers have prove, by their results, a good tracking of the MPPT compare with the other methods which are proposed up to now.*

Résumé – *Les caractéristiques de sortie des systèmes photovoltaïques sont non linéaires et varient avec les variations de température et d'irradiation, de ce fait, nous avons besoin d'un contrôleur nommé contrôleur de point de puissance maximal MPPT pour extraire la puissance maximale au niveau du terminal du générateur photovoltaïque. Cette étude, explore deux contrôleurs intelligents, basés sur les réseaux de neurones et la logique floue afin de suivre ce point. Ces deux contrôleurs ont prouvé par leurs résultats, un bon suivi de point de puissance maximum et ceci en comparaison avec les autres méthodes qui sont proposées jusqu'à présent.*

Keywords: Photovoltaic - Maximum power point tracking - P&O – Styling - Neural networks.

1. INTRODUCTION

Photovoltaic (PV) cells are an attractive source of energy. Abundant and ubiquitous, this source is one of the important renewable energy sources that have been increasing worldwide year by year [1].

In the V–P characteristic curve of GPV, there is a maximum point called the maximum power point (MPP). With the varying atmospheric conditions and because of the rotation of the earth [2], the irradiation and temperature keeps on changing throughout the day. So, it is a big challenge to operate a PV module consistently on the maximum power point and for which many MPPT algorithms have been developed [3].

In this paper, we propose to study the modeling of a photovoltaic system and to find a method for optimizing the operation of the PV generator using intelligent neural network and fuzzy logic controller.

* dr_nadia22@hotmail.com , lbarazane@yahoo.fr

† m_loudini@esi.dz

2. PHOTOVOLTAIC POWER GENERATION

The photovoltaic solar energy comes from the direct conversion of a portion of solar radiation into electrical energy carried through a photovoltaic cell based on physical phenomenon called photovoltaic effect. The role of this latter consists on producing an electromotive force when the surface of the cell is exposed to light [4].

The association of several PV cells in series-parallel gives rise to a photovoltaic generator (GPV), which has a current-voltage ($I-V$) non linear with an operating point (MPP) which depends on the illumination level and temperature and aging of all [4].

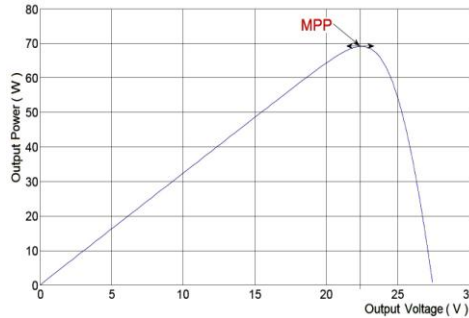

Fig. 1: Power curve under standard condition

Fig. 1 shows the output characteristics $P-V$ of PVG, so to extract at each moment the maximum power at the terminals of PVG insertion of maximum power point tracker (MPPT) is necessary between the photovoltaic module and load (Fig. 2).

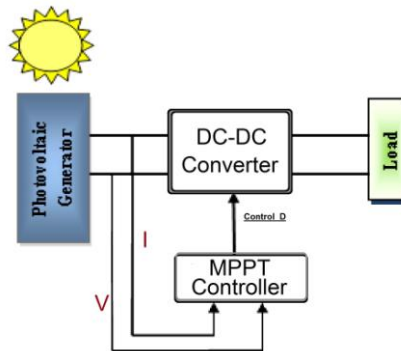

Fig. 2: Photovoltaic system

In the following, we present the two intelligent controllers, and compare here performance via numerical simulation.

3. ARTIFICIAL NEURAL NETWORKS

Artificial neural networks (ANN) are intelligent systems that have the capacity to learn, memorize and create relationships among data. ANN are able to learn key information patterns within a multidimensional information domain [5].

The artificial neural network (ANN) is considered as an assembly of elements of identical structure called cells (or neurons) interconnected like cells of the vertebrate nervous system. Each point of connection (called the coefficient or weight) between two cells acts as a synapse, the main element of interaction between neurons. These connections or synaptic weights have a role in the parallel operation and adaptive neural networks where the notion of connectionist [6].

Each cell receives entries in vector form (X), makes a sum weighted (a), and generates by means of a transfer function (G) linear or not, a real result (Y) of the form:

$$Y = G \times (W \times X + b) \quad (1)$$

$W = (w_{i,1}, w_{i,2}, \dots, w_{i,N})$ are the weights of the neuron i (or weight matrix), $X = (x_1, x_2, \dots, x_N)$ are the inputs of the neuron i (or input vector), b is the bias of the neuron, and $\alpha = (b + W \times X)$ is the weighted sum of inputs called net inflow or potential of neuron i , and is the argument of the transfer function (or function activation) G of the neuron i .

The neural network consists of an input, a hidden and output layer.

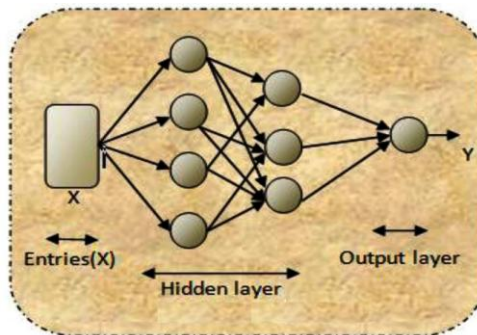

Fig. 3: Architecture of a neural network

Training is the process of modifying the connection weights in some orderly fashion using training algorithm.

3.1 Description and architecture the proposal MMPT Neural controller

The architecture of proposed MPPT neural network intended to replace the MPPT controller is shown in Fig. 4.

ANN controller is selected as a static, multilayer network, it consists of three layers as follows:

- An input layer with two neurons (temperature T and the irradianations S)
- Two hidden layers- the first with 5 neurons and the second with 8 neurons,
- An output layer with one neuron (ratio cyclic D).

In addition, the activation functions are adopted for the hyperbolic sigmoid neurons entered and those of hidden layers, whereas that corresponding to the output neuron is chosen linear.

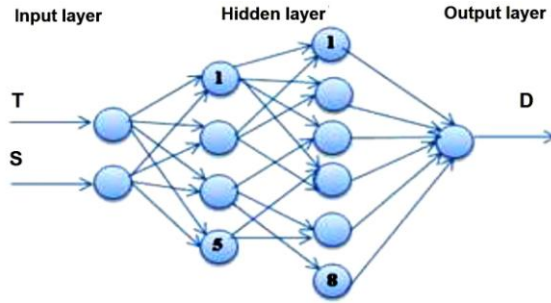

Fig. 4: The proposed neural network architecture

The number of neurons in the hidden layer has been optimized empirically during the learning phase. Indeed, the Tests have shown that the most stable structure is that composed of five neurons in first hidden layer and eight neurons for the second hidden layer.

It is also note worthy that the choice of the function activation of the hidden layer for which we opted not been adopted arbitrarily, but was chosen after several tests which showed that the function sigmoid hyperbolic converges faster by relative to the sigmoid tangential function during phase learning.

Once our photovoltaic chain designed, and to verify the ability of our neural network controller to improve his performance, numerical simulation is present in the following paragraph.

3.2 Simulation study

The ANN controller is simulated under the following test:

- Simulation of system operation under constant conditions (standard): A temperature of 25 °C and an irradiation of 1000 W/m² (Fig. 5-a).

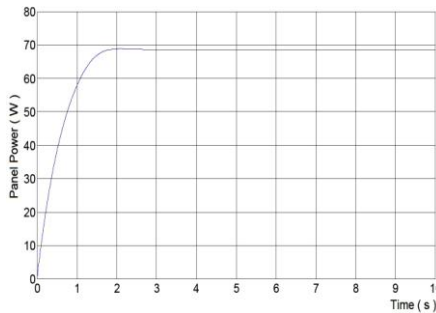

Fig. 5-a: Simulation results of the systems under constant conditions (standard)
A temperature of 25 °C and an irradiation of 1000 W/m²

- Simulations under varying conditions of temperature: Variation of the power module for increasing the temperature of 20 °C to 45 °C in 2 seconds with an irradiation of 1000 W/m² (Fig. 5-b).
- Simulations under varying conditions of irradiation: Variation of the power module, for decrease in sunlight from 1000 to 900 W/m² and an increase to 1000 W/m² in 2 seconds with a constant temperature of 25 °C (Fig. 5-c).

- Simulations under varying conditions of temperature and irradiation (Fig. 5-d).

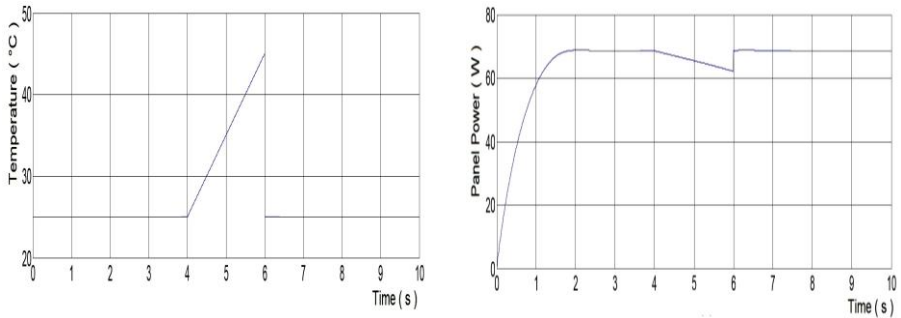

Fig. 5-b: Simulation results of the systems under varying conditions of temperature: (Temperature of 25 °C with an irradiation of 1000 W/m²)

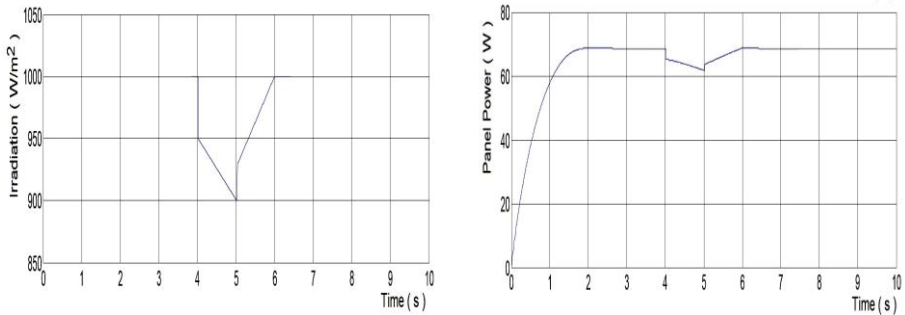

Fig. 5-c: Simulation results of the systems under varying conditions of irradiation: (Irradiation from 1000 to 900 W/m² with a constant temperature of 25 °C)

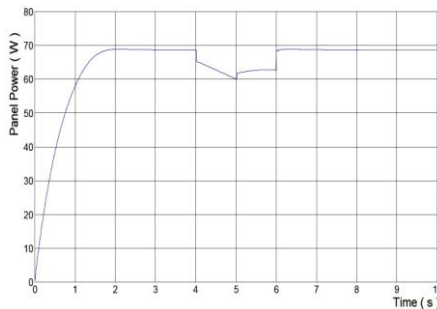

Fig. 5-d: Simulation results of the proposed neural network control for the considered different conditions

4. FUZZY LOGIC

Fuzzy logic controllers, ‘FLC’ have the advantages of working with imprecise inputs, no need to have accurate mathematical model, and it can handle the non linearity [7].

Fig. 6 show the proposed ‘FLC’; it consists of two inputs and one output. The two FLC input variables are the error (E) and change of error (ΔE) that expressed by equation (2).

$$\begin{cases} E(n) = \frac{P(n) - P(n-1)}{V(n) - V(n-1)} \\ \Delta E(n) = E(n) - E(n-1) \end{cases} \quad (2)$$

where E and ΔE are the error and change in error, n is the sampling time, P(n) is the instantaneous power of the PVG, and V(n) is the corresponding instantaneous voltage.

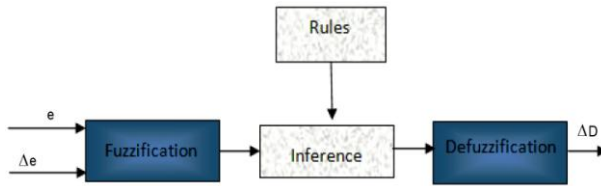

Fig. 6: Fuzzy system

The fuzzy controller design contains the three following steps:

▪ **Fuzzification**

The system converts the actual inputs values E and CE into linguistic fuzzy sets using fuzzy membership function.

These variables are expressed in terms of five linguistic variables (such as PB (positive big), PS (positive small), ZE (zero), NB (negative big), NS (negative small) as show in Fig. 7.

▪ **Inference and rule base:**

Inference engine is an operating method that formulates a decision based on the fuzzy rule setting and transforms the fuzzy rule base into fuzzy linguistic output. In this paper Mamdani’s fuzzy inference method, with Max-Min operation has been used.

Fuzzy rule base is a collection of if-then rules that contain all the information for the controlled parameters. **Table 1** presents the fuzzy control rules.

• **Defuzzification**

The fuzzy logic output is converted from a linguistic variable to a numerical variable.

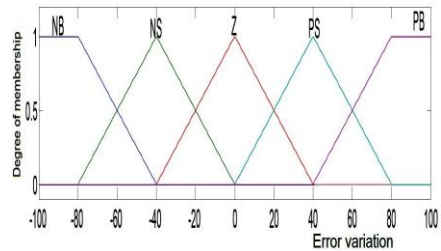
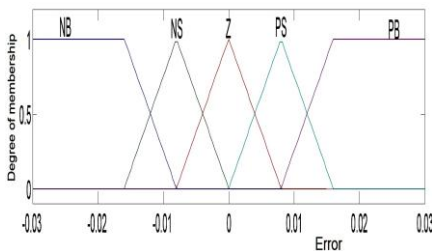

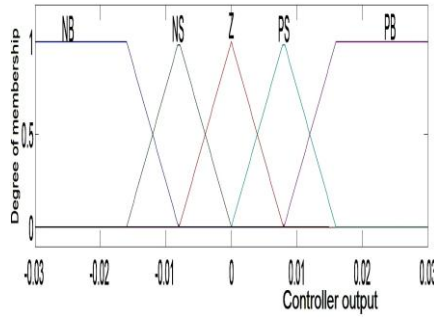

Fig. 7: Membership function of FLC

Table 1: Fuzzy table rule

E \ ΔE	NB	NS	ZE	PS	PB
NB	ZE	ZE	NB	NB	NB
NS	ZE	ZE	NS	NS	NS
ZE	NS	ZE	ZE	ZE	PS
PS	PS	PS	PS	ZE	ZE
PB	PB	PB	PB	ZE	ZE

Simulation study

To verify the ability of our fuzzy controller to improve the performance obtained under the neural network controller, we performed the same test as applied in paragraph 3.2

The simulation results are shown in Fig. 8-a for the standard conditions, Fig. 8-b for the variation of temperature, Fig. 8-c for variation of irradiation, and Fig. 8-d for variation of temperature and irradiation respectively.

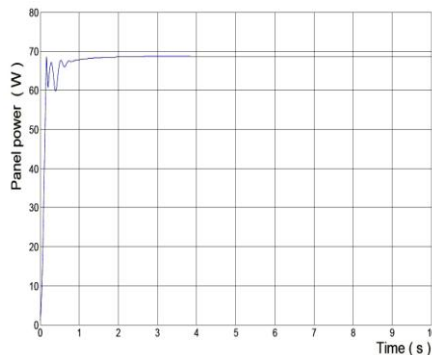

Fig. 8-a: Simulation results of the systems for the standard conditions

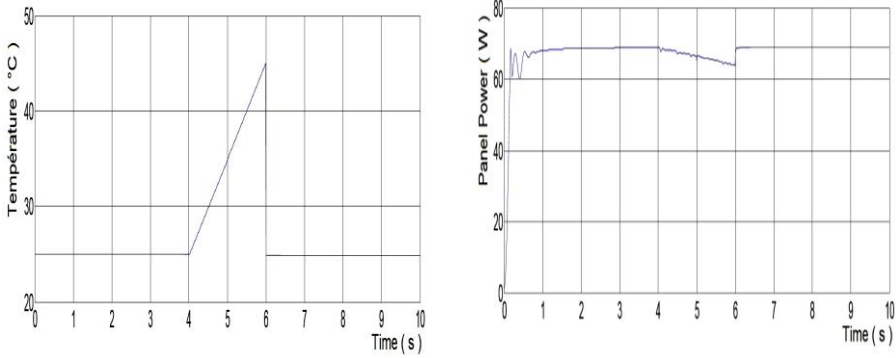

Fig. 8-b: Simulation results of the systems for the variation of temperature

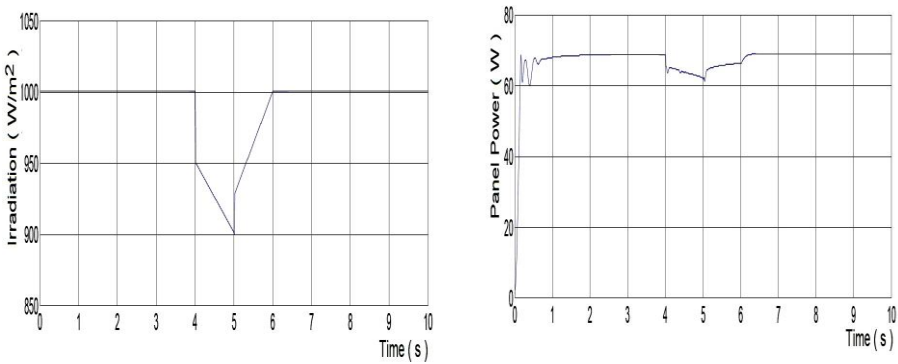

Fig. 8-c: Simulation results of the systems for the variation of irradiation

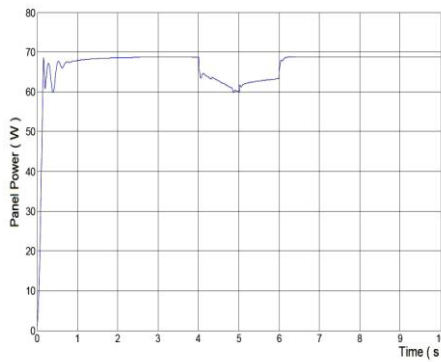

Fig. 8-d: Simulation results of the systems for the variation of temperature and irradiation

As can be seen, the FLC is more fast then the neural network controller; moreover the FLC presents oscillations before achieve the MPP. In standard conditions the two controllers presents no overshoot and the maximum power point is well monitored by the both.

According to the tests of variation of temperature and irradiation, we notice that the neural network controller behaves exactly as expected for different variations considered contrary to the FLC with presents some fluctuation.

5. CONCLUSION

In this paper we have investigated two intelligent control techniques to manage the output power of the solar panel in order to obtain the maximum power possible, whatever the solar irradiation and temperature conditions.

The design and simulation of neural network and fuzzy logic based MPPT was presented.

According to the obtained results we can say that the use of intelligent controller to track the maximum power point in PV systems is very promising. In fact, the two controllers have presents good performances: fast responses for FLC with some fluctuations and no overshoot in neural network controller.

Ongoing research, and in order to get the fast responses and no presence of fluctuations, the hybridation of the two controller will be developed.

REFERENCES

- [1] A. Goetzberger and V.U. Hoffmann, '*Photovoltaic Solar Energy Generation*', Springer, 232 p., Germany, 2005.
- [2] P.S. Revankar, W.Z. Gandhare and A.G. Thosar, '*Maximum Power Point Tracking for PV Systems Using Matlab/Simulink*', In Proceedings, Second International Conference on Machine Learning and Computing, 'ICMLC', Bangalore, India, pp. 8 – 11, 2010.
- [3] T. Eswam and P.L. Chapman, '*Comparison of Photovoltaic Array Maximum Power Point Tracking Techniques*', IEEE Transactions on Energy Conversion, Vol. 22, N°2, pp. 439 – 449, 2007.
- [4] M.A. Cid Pastor, '*Conception et Réalisation de Modules Photovoltaïques Electroniques*', Thèse de Doctorat, Institut National des Sciences Appliquées, Toulouse, France, 2006.
- [5] S.A. Kalogirou, '*Artificial Neural Networks in Renewable Energy Systems Applications: A Review*', Renewable and Sustainable Energy Reviews, Vol. 5, N°4, pp. 373 – 401, 2001.
- [6] A. Panda, M.K. Pathak and S.P. Srivastava, '*Fuzzy Intelligent Controller for the Maximum Power Point Tracking of a Photovoltaic Module at Varying Atmospheric Conditions*', Journal of Energy Technologies and Policy, Vol. 1, N°2, pp. 18 - 27, 2011
- [7] S. Amamra, '*Commande par Réseaux de Neurones d'une Machine Asynchrone avec Linéarisation Hybride*', Mémoire de Magister, Ecole Nationale Polytechnique, Alger, 2005.