

Doubly fed induction generator, with crow-bar system, under micro-interruptions fault

M.A. Dami, K. Jemli*, M. Jemli and M. Gossa

Unité de Recherche en Commande, Surveillance et Sécurité de Fonctionnement des Systèmes, 'C3S'
Ecole Supérieure des Sciences et Techniques de Tunis, 'ESSTT'
5 Avenue Taha Hussein, B.P. 56, Bab Mnara, 1008 Tunis, Tunisie

(reçu le 16 Juillet 2010 – accepté le 25 Décembre 2010)

Abstract – *The work presented in this paper focuses on studying the application of doubly fed induction generators in wind energy production under micro-interruption fault. In this context, we set out to improve the performance of a wind turbine either from an energetic efficiency, or from the arrangement with behavioral of grid disturbances. To reach the maximum wind power extraction, wind turbine has to reduce their disconnection. For this reason grid operators impose, by theirs grid connection requirements, to wind turbine producer to support some grid disturbance. This paper deals with the behavior of wind turbine equipped with a Doubly Fed Induction Generator (DFIG) under micro-interruption. A scheme tolerant micro-interruption is proposed. A control strategy of the Unified Power Flow Control (UPFC) using PI controller is presented. And finally fuzzy logic controller is illustrated and compared to PI controller.*

Résumé - *Le travail présenté dans cet article se concentre sur l'étude de l'application de génératrices asynchrones à double alimentation dans la production d'énergie éolienne assujettie aux micro coupures. Dans ce contexte, nous avons cherché à améliorer le rendement d'une éolienne, soit du point de vue de l'efficacité énergétique, soit au point de vue de l'arrangement avec comportement des perturbations du réseau. Pour atteindre l'extraction du vent de la puissance maximale, l'éolienne doit réduire les déconnexions. Pour cette raison, les gestionnaires de réseau imposent, par leurs exigences de raccordement au réseau, aux producteurs de turbines à soutenir certaines perturbations du réseau. Cet article traite du comportement de l'éolienne équipée d'un générateur à induction à double alimentation (MADA) en vertu des micro coupures. Un régime de tolérance micro-coupure est proposé. Une stratégie de contrôle unifiée Power Flow (UPFC) en utilisant le contrôleur PI est présentée. Et enfin un contrôleur de logique floue est illustré et comparé aux régulateurs PI.*

Keywords: Wind energy - Doubly Fed Induction Generator - Micro-interruption - Fault - Crowbar - Fuzzy logic controller.

1. INTRODUCTION

The increasing integration of wind energy in the production of electrical energy restructures the way that wind frame is operated. In Denmark an annual average of 15 % of the total power is developed by wind farms. During certain periods of high wind and low consumption the main part of electrical energy is developed by wind farm.

* Kamel.jemli@yahoo.fr - kamel.jemli@isetzg.rnu.tn

The increasing number of wind farms causes that more other country countries can face a similar situation in the next few times. However the increase on part of wind energy compared to the capacity of the electrical grid can cause problems for the operators such as the variation of the tension, the imbalance and the instability of the network. [2]

The disconnection of a wind turbine causes important losses in possible electrical energy. To reach the objective of reducing the rate of disconnection the operators on the electrical grid impose, in their wind grid connection requirements, a variety of tolerance to the network disturbances such as the micro-interruptions, voltage dips, frequency variation,... for that wind farms are called to support some grid disturbances.

The behavior of wind turbine under grid disturbances depend on type of generator (induction generator, synchronous generator...), and scheme of connection to the electric grid (squirrel cage directly connected to the grid, doubly fed induction generator...).

In this work, we study a wind turbine using the Doubly Fed Induction Generator (DFIG). This paper deals with the micro-interruptions faults. Thus it is necessary to study the behavior of DFIG under micro interruptions faults, present a solution allowing to the DFIG to support micro-interruption and design fuzzy logic controllers to improve the performance of DFIG under such category of fault.

2. STUDIED SYSTEM

The studied system is composed by a wound rotor induction generator connected to the electric grid within rotor and stator. The stator is directly connected to the grid and the rotor is connected to the grid by the Unified Power Flow Control (UPFC). Such system has the capacity to deliver the electric power with voltage and frequency constants for a variation of the speed of ± 20 to 40 % around the synchronous speed. [6]

Figure 1 shows the schematic configuration of the DFIG. The UPFC is a power electronics device composed by two converters C_{rot} and C_{grid} . Coordinated control of the UPFC is proposed in section 3.

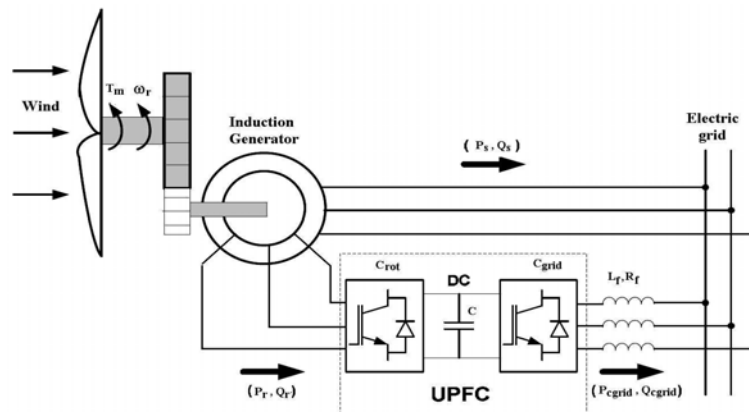

Fig. 1: Configuration of a doubly fed induction generator (DFIG)

For this study it is assumed that the DFIG is subjected to a grid micro-interruption fault. Behaviors of DFIG wind turbine under micro-interruption fault are studied in section 4. Scheme tolerant such fault is provided in section 5. and finally fuzzy logic controllers are illustrated in section 6.

2.1 Wind turbine

A simplified aerodynamic model is normally used when the electrical behavior of the wind turbine is the main interest of the study.

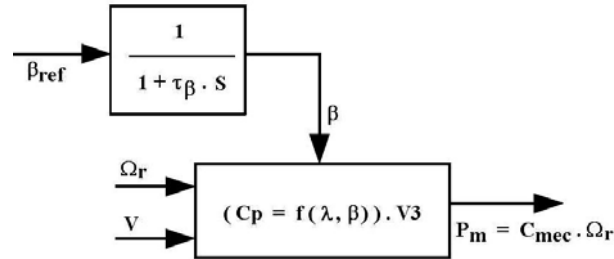

Fig. 2: Schematic of a wind turbine

The relation between the wind speed and mechanic power, delivered by the wind turbine, can be described by the following equation:

$$P_m = \frac{1}{2} \pi \cdot \rho \cdot R^2 \cdot v^3 \cdot C_p(\lambda, \beta) \quad (1)$$

Where, ρ : Specific mass of the air (kg/m^3); v : Wind speed (m/s); R : Radius of turbine (m); C_p : Power coefficient.

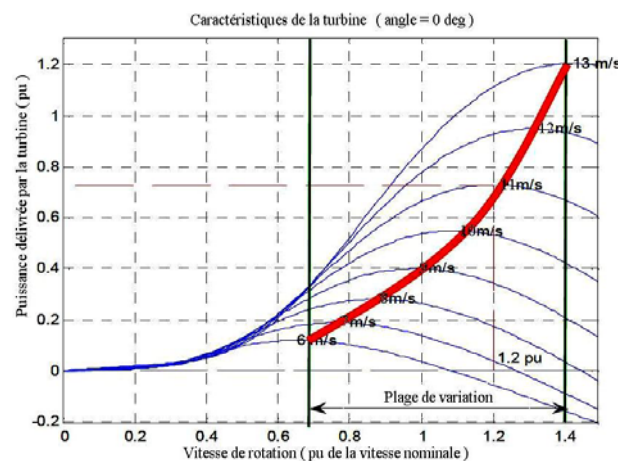

Fig. 3: Turbine characteristics

Wind turbine model have two control schemes: speed control and pitch control. The speed control can be realized by adjusting the generator power or torque. The pitch control is a common control method to regulate the mechanic power from the turbine. [1]

2.2 Induction generator

Using the electric equations of the wound rotor induction machine given by the following equation system [2]:

$$\begin{bmatrix} v_{ds} \\ v_{qs} \\ v_{dr} \\ v_{qr} \end{bmatrix} = \begin{bmatrix} R_s + L_{sp} & -\omega_{dq} L_s & L_{np} & -\omega_{dq} L_m \\ \omega_{dq} L_s & R_s + L_{sp} & \omega_{dq} L_m & L_{np} \\ L_{np} & -L_n (\omega_{dq} - \omega) & R_s + L_{rp} & -L_r (\omega_{dq} - \omega) \\ L_m (\omega_{dq} - \omega) & L_{np} & L_r (\omega_{dq} - \omega) & R_s + L_{rp} \end{bmatrix} \times \begin{bmatrix} i_{ds} \\ i_{qs} \\ i_{dr} \\ i_{qr} \end{bmatrix} \quad (2)$$

The mechanical equation of the generator is:

$$J \cdot \frac{d\omega_r}{dt} = n_p \cdot (T_m - T_e) \quad (3)$$

The electromagnetic torque is:

$$T_m = n_p \cdot L_m \cdot (i_{dr} i_{qs} - i_{qr} i_{ds}) \quad (4)$$

With, T_m : Mechanical torque; T_e : Electromagnetic torque; n_p : Number of poles pairs; J : Effective inertia of the revolving part.

2.3 Unified power flow controllers 'UPFC'

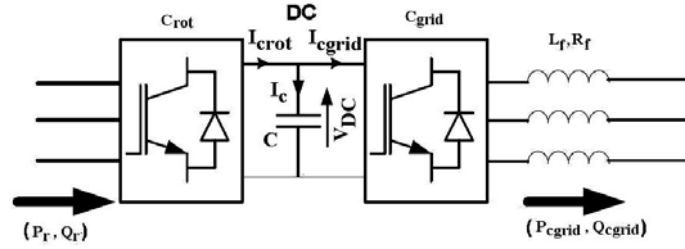

Fig. 4: Unified Power Flow Controllers, 'UPFC'

$$P_m = T_m \times \Omega_r \quad (5)$$

$$P_s = T_e \times \Omega_s \quad (6)$$

In steady state and at fixed speed;

$$T_m = T_e \quad \text{and} \quad P_m = P_s + P_r \quad (7)$$

$$\begin{aligned} P_r &= P_m - P_s = T_m \times \Omega_r - T_e \times \Omega_s \\ &= -T_m \times (\Omega_r - \Omega_s) = -s \times P_s \end{aligned} \quad (8)$$

$$C \times V_{DC} \times \frac{dV_{DC}}{dt} = P_{Crot} - P_{Cgrid} \quad (9)$$

$$i_C = C \times \frac{dV_{DC}}{dt} = i_{Crot} - i_{Cgrid} \quad (10)$$

With, $P_{Crot} = s \times P_s$.

3. CONTROL ALGORITHM

In this part, it is necessary to establish the control strategy of the two converters C_{rot} and C_{grid} (respectively converter side rotor and grid side converter) as well as the angle of orientation of pale (pitch angle). The two converters (C_{grid} and C_{rot}) can control the active power of the turbine, the voltage of the continuous bus and the reactive power.

3.1 Control of the side rotor converter C_{rot}

We choose a synchronously rotating reference frame so that the d-axis thus coincides with the desired direction of stator flux; hence, the flux expression will be:

$$\Psi_{ds} = \Psi_s = L_s \cdot i_{ds} + L_m \cdot i_{dr} \quad (11)$$

$$\Psi_{qs} = L_s \cdot i_{qs} + L_m \cdot i_{qr} = 0 \quad (12)$$

The electromagnetic torque will be reduced to:

$$T_e = n_p \times \frac{L_m}{L_s} \times (\Psi_{ds} \times i_{qr}) \quad (13)$$

By neglecting resistance of the stator phases, the stator voltage will be expressed by:

$$v_s \approx \frac{d\Psi_s}{dt} \quad (14)$$

We can also deduce:

$$v_{qs} = 0 \quad \text{and} \quad v_{qs} = V_s = \omega_s \cdot \Psi_{ds}$$

The equation [13] and [14] give these next expressions of the 'd' and 'q' stators currents:

$$i_{ds} = \frac{\Psi_{ds}}{L_s} - \frac{L_m}{L_s} \cdot i_{dr} \quad (15)$$

$$i_{qs} = -\frac{L_m}{L_s} \cdot i_{qr} \quad (16)$$

We lead to an uncoupled power control; where, the transversal component i_{qr} of the rotor current controls the active power. The reactive power is imposed by the direct component i_{dr}

$$P = -v_s \times \frac{L_m}{L_s} \times i_{qr} \quad (17)$$

$$Q = \frac{v_s \times \Psi_{ds}}{L_s} - \frac{v_s \times L_m}{L_s} \times i_{dr} \quad (18)$$

The arrangement of the equations gives the expressions of flux and the voltages according to the rotor currents:

$$\begin{cases} \Psi_{dr} = \left(L_r - \frac{L_m^2}{L_s} \right) \cdot i_{dr} + \frac{L_m \cdot v_s}{\omega_s \cdot L_s} \\ \Psi_{qr} = \left(L_r - \frac{L_m^2}{L_s} \right) \cdot i_{qr} \end{cases} \quad (19)$$

$$\begin{cases} v_{dr} = R_r \cdot i_{dr} + \left(L_r - \frac{L_m^2}{L_s} \right) \cdot \frac{di_{dr}}{dt} - g \cdot \omega_s \cdot \left(L_r - \frac{L_m^2}{L_s} \right) \cdot i_{qr} \\ v_{qr} = R_r \cdot i_{qr} + \left(L_r - \frac{L_m^2}{L_s} \right) \cdot \frac{di_{qr}}{dt} - g \cdot \omega_s \cdot \left(L_r - \frac{L_m^2}{L_s} \right) \cdot i_{dr} + g \cdot \omega_s \cdot \frac{L_m \cdot v_s}{\omega_s \cdot L_s} \end{cases} \quad (20)$$

Note by:

$$\sigma = 1 - \frac{L_m^2}{L_s \cdot L_r}$$

$$e1 = -g \cdot \omega_s \cdot \sigma \cdot L_r \cdot i_{qr}$$

$$e2 = g \cdot L_m^2 \cdot v_s / L_s - g \cdot \omega_s \cdot \sigma \cdot L_r \cdot i_{qr}$$

ω_0 and ξ denote natural frequency and damping ration, respectively.

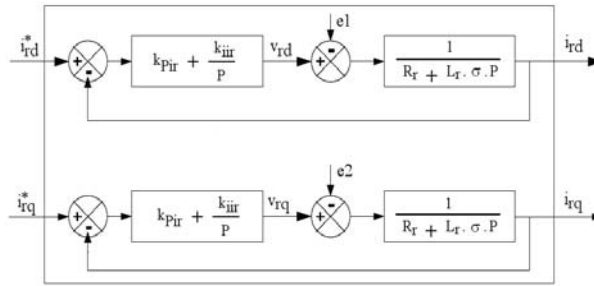

Fig. 5: Rotor current regulator diagram block

The optimal response is obtained for $\xi = 0.7 \Rightarrow \omega_0 \times t_r = 3$.

By choosing a system response time (t_r) we can deduce K_{iir} and K_{pir} (PI regulator coefficients)

$$\omega_0 = 3/t_r$$

$$K_{iir} = \frac{\omega_0^2 \times \tau}{K} \quad (21)$$

$$K_{pir} = \frac{\xi \times 2 \omega_0 \times (\tau - 1)}{K} \quad (22)$$

3.2 Control of the grid side converter C_{grid}

$$i_C = C \times \frac{dV_{DC}}{dt} = i_{Crot} - i_{Cgrid} \quad (23)$$

$$C \times V_{DC} \times \frac{dV_{DC}}{dt} = P_{Crot} - P_{Cgrid} \quad (24)$$

With: $P_{Crot} = g \times P_s$

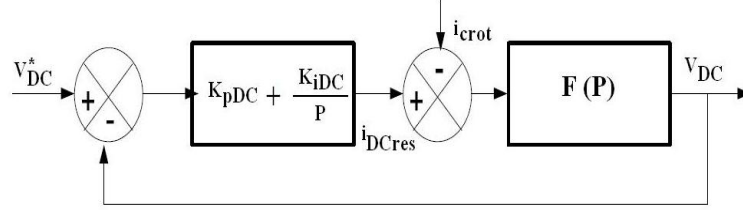

Fig. 6: Continuous bus voltage regulation block diagram

where K_{pDC} and K_{iDC} denote proportional and integral gains of the, continuous bus, (PI) controller.

So we can deduce the regulator parameter:

$$K_{iDC} = \omega_0^2 \times C \quad (25)$$

$$K_{pDC} = 2\omega_0 \times \xi \times C \quad (26)$$

where ω_0 and ξ denote natural frequency and damping ratio, respectively.

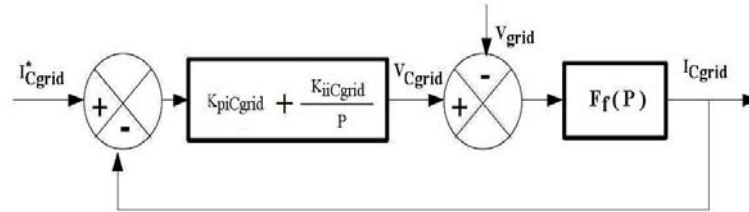

Fig. 7: C_{grid} Converter current regulation block diagram

Then we can deduce the PI regulator coefficient ($K_{piCgrid}$, $K_{iiCgrid}$):

$$K_{piCgrid} = 2L_f \times \xi \times \omega_0 - R_f \quad (27)$$

$$K_{iiCgrid} = L_f \times \omega_0^2 \quad (28)$$

where: V_{DC} : Voltage of the continuous bus; I_{Cgrid} : Current delivered by the grid side converter; V_{Cgrid} : Voltage of the grid side converter; V_{grid} : Stator voltage (Grid voltage); L_f : Smoothing bobbin self inductance; R_f : Smoothing bobbin resistance; ω_s : Stator pulsation; *: Reference value.

4. DFIG WIND TURBINE UNDER MICRO-INTERRUPTION

In this section behaviors of DFIG wind turbine under micro-interruption fault are studied. The micro-interruption is a disconnection of the electric grid for a short moment.

For the case of the generating operation of an asynchronous machine the electric grid interruption makes the system similar to a stand alone induction generator. In this case the amplitude and the frequency of the generator will not be assisted any more by the electric grid.

That makes the generators terminal voltage values depending on magnetizing and speed of the generator. On this fact the influence of a micro-interruption on a wind turbine depends on the used structure of generator (DFIG, asynchronous generator directly connected to the grid, ...).

Using the equivalent circuit, in transitory mode, of the induction machine given by the following figure we can establish its electric equations.

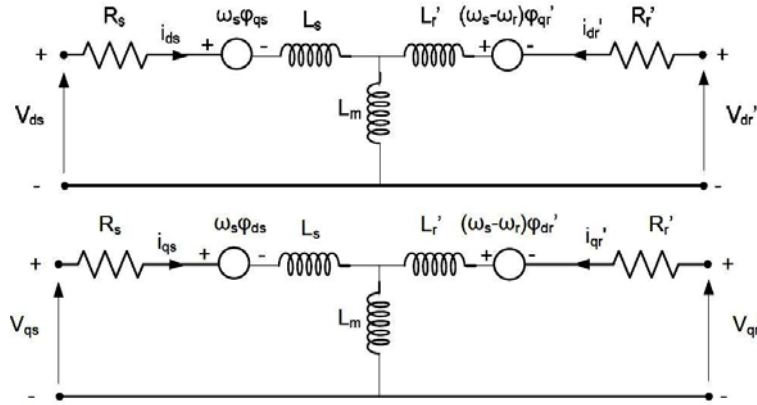

Fig. 8: Schéma équivalent de la machine asynchrone selon l'axe 'd' et l'axe 'q'

$$V_{ds} = R_s \times i_{ds} + \frac{\partial \phi_{ds}}{\partial t} - \omega \times \phi_{qs} \quad (29)$$

$$V_{qs} = R_s \times i_{qs} + \frac{\partial \phi_{qs}}{\partial t} + \omega \times \phi_{ds} \quad (30)$$

$$V_{dr}' = R_r' \times i_{dr}' + \frac{\partial \phi_{dr}'}{\partial t} - (\omega - \omega_r) \times \phi_{qr}' \quad (31)$$

$$V_{qr}' = R_r' \times i_{qr}' + \frac{\partial \phi_{qr}'}{\partial t} - (\omega - \omega_r) \times \phi_{dr}' \quad (32)$$

$$T_e = n_p \times \frac{M}{L_r} \times (\phi_{dr}' \times i_{qs} - \phi_{qr}' \times i_{ds}) = n_p \times (\phi_{ds} \times i_{qs} - \phi_{qs} \times i_{ds}) \quad (33)$$

Under micro-interruption between the network and the wind turbine the amount of power delivered to the electric grid will be forwarded towards the rotor. This

amplifies excessively the rotor current and consequently increases the stator tensions see equation (29) and (30).

For the active and reactive powers, during a sudden increase in the rotor current caused by a micro-interruption, a peak with a positive value appears in the active power curve and a peak with negative value appears in the reactive power curve. This is confirmed by the following expressions of the active and reactive power:

$$P_s = \frac{3}{2} \omega_s \times \frac{M^2}{L_s} \times I_m \times I_{rq} \quad (34)$$

$$Q_s = \frac{3}{2} \omega_s \times \frac{M^2}{L_s} \times I_m \times (I_m - I_{rd}) \quad (35)$$

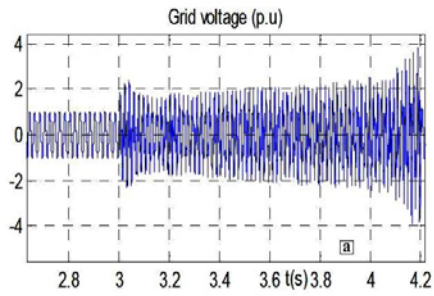

a- Grid voltage

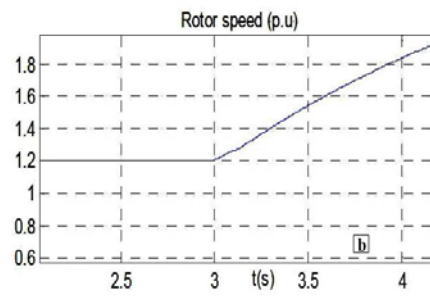

b- Generator speed

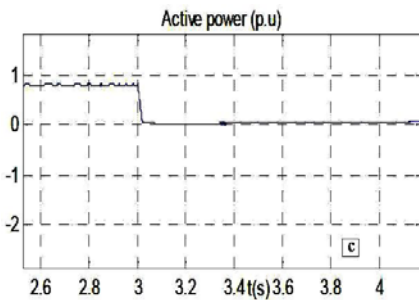

c- Active power

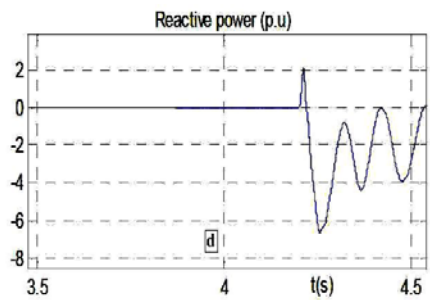

d- Reactive power

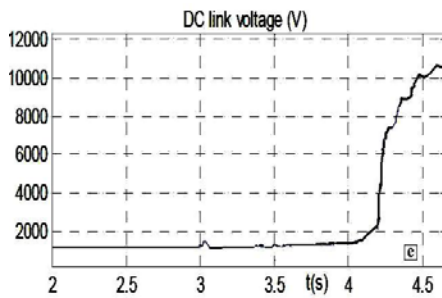

e- DC link voltage

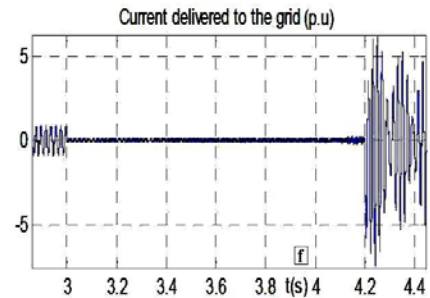

f- Rotor active power

Fig. 9: Time of micro-interruption appearance: $t = 3$ s

Figure 9 shows that under micro-interruption wind turbine based on DFIG diverges. Note that the UPFC is dimensioned to support only 30 % of the rated power. Then this device, under micro-interruption of the electric grid, will be damaged. So we must protect these converters. Some uses the crow-bar as a method of protection. It makes possible to short circuit the rotor and to insulate the converters. [7]

The diagram of a wind turbine based on DFIG using a crow-bar is given by the figure 10.

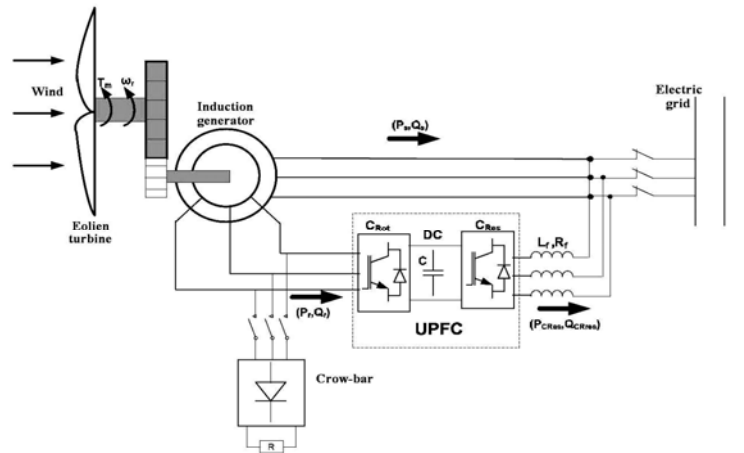

Fig. 10: diagram of a wind turbine based on DFIG using a crow-bar system

The proposed solution permits the protection of the power electronics device. But it is limited since it does not allow the system to recover in energy production after departure of the micro-interruption.

In fact with the appearance of a micro interruption the system is disconnected from the electric grid and it is necessary for him a new starting launch. That causes a production loss for the duration between the disappearance of the micro-interruption and the re-establishment of the system in energy production.

5. SCHEME TOLERANT MICRO-INTERRUPTION FAULT

In this section, we will present a method allowing a wind turbine, based on a DFIG, to tolerate the micro-interruptions.

This method is based on the use of a crow-bar inserted between the wind turbine and the electric grid as presented in the figure 11.

To improve the performance of this system an evaluation of the behavior of the system, under micro-interruption, using two types of regulators (PI regulator and Fuzzy Logic regulator) is presented.

In safety condition the crow-bar is disconnected. When a micro-interruption appears the crow-bar is immediately activated in order to absorb the power delivered by the generator. A dimensioning of crow-bar power is necessary.

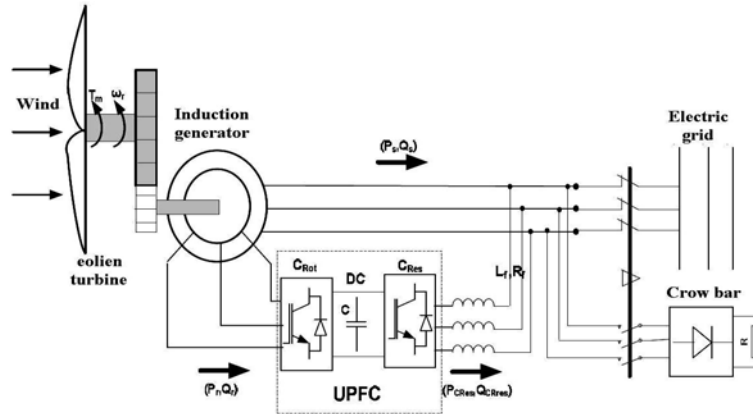

Fig. 11: Doubly Fed Induction Generator (DFIG) with a crowbar system

Obtained results

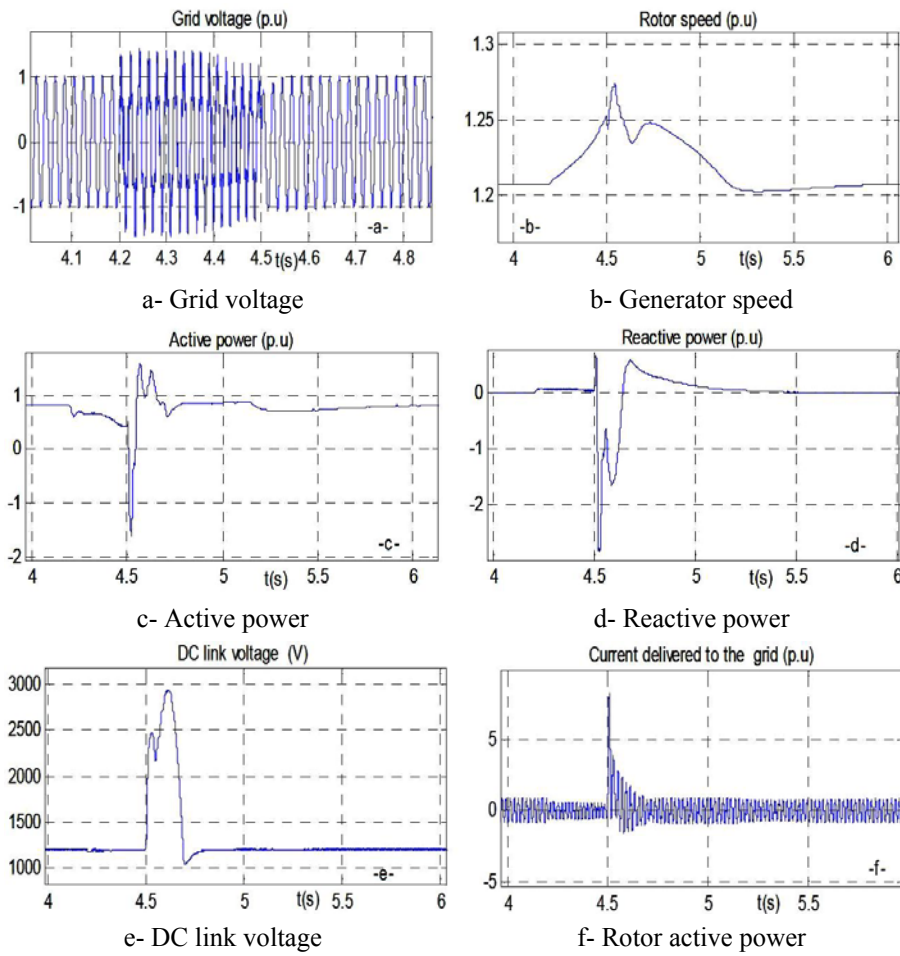

Fig. 12: Results obtained with a PI regulator

6. FUZZY LOGIC REGULATION

Previously fuzzy logic has not been used much in wind turbine control. One of the main reasons for this is that most of the wind turbine control tasks have been in the small signal range, where linear PI and PID controllers perform well. [8]

For transient mode, the case of micro-interruption and voltage dip, the system becomes difficult to describe mathematically. This is the prime area for application of fuzzy logic control.

6.1 Regulator conception

The structure of the current fuzzy logic controller is given by the next figure:

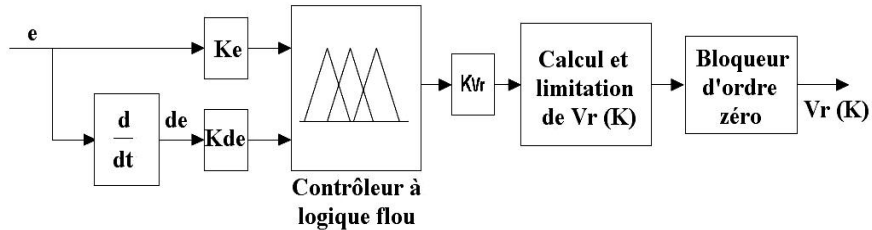

Fig. 13: Diagram of fuzzy logic controller

Figure 14 illustrates membership functions of the input variables. Note by: NB: Negative Big; PB: Positive Big; NM: Negative Medium; PM: Positive Medium; NS: Negative Small; PS: Positive Small; ZE: Zero

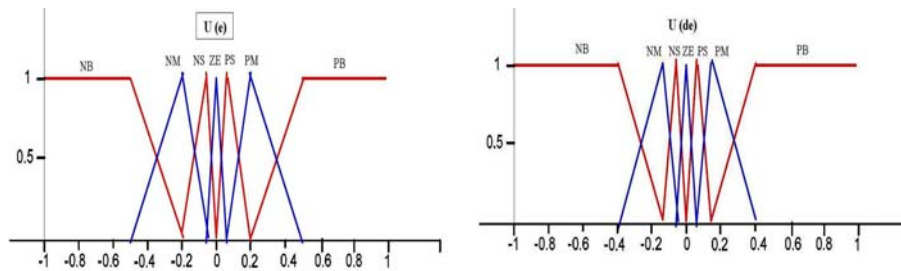

Fig. 14: Inputs membership functions

Output membership functions are shown by the next figure:

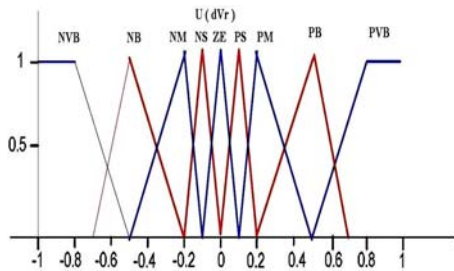

Fig. 15: Output membership functions

With, NVB: Negative Very Big; PVB: Positive Very Big.

The following table illustrates the rules giving dV_r according to the states of the error “e” and the variation of the error “de”.

Table 1: Base of rules relative to the current fuzzy logic regulator

		e						
		NB	NM	NS	ZE	PS	PM	PB
de	NB	NVB	NVB	NVB	NB	NM	NS	ZE
	NM	NVB	NVB	NB	NM	NS	ZE	PS
	NS	NVB	NB	NM	NS	ZE	PS	PM
	ZE	NB	NM	NS	ZE	PS	PM	PB
	PS	NM	NS	ZE	PS	PM	PB	PVB
	PM	NS	ZE	PB	PVB	PB	PVB	PVB
PB	ZE	PS	PM	PB	PVB	PVB	PVB	

A synthesis based on the heuristics allows the determination of the gains K_e , K_{de} and K_s corresponding respectively to the error, the variation of the error and the output.

6.2 Obtained results

During the appearance of a micro-interruption, between the electric grid and the wind turbine, the crow-bar is activated in order to absorb the energy provided by the DFIG. The system becomes similar to a stand alone wind turbine using a DFIG. When the micro-interruption disappears and the system is connected again to the electric grid a transient mode appears. This is due to the voltage difference explained in the section 4.

This phenomenon is translated by peaks in power, current and voltage of the DFIG. The use of the fuzzy logic controller for the rotor current shows a clear superiority in front of PI regulators. The results obtained show how the fuzzy logic regulators reduce well the transitory mode in amplitude and time of re-establishment of the system.

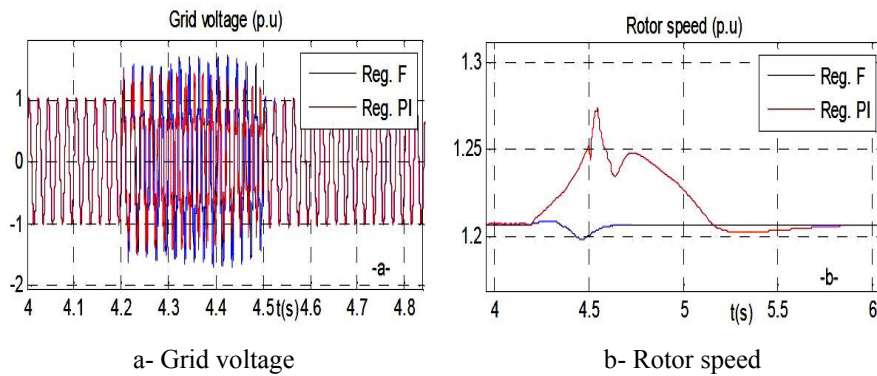

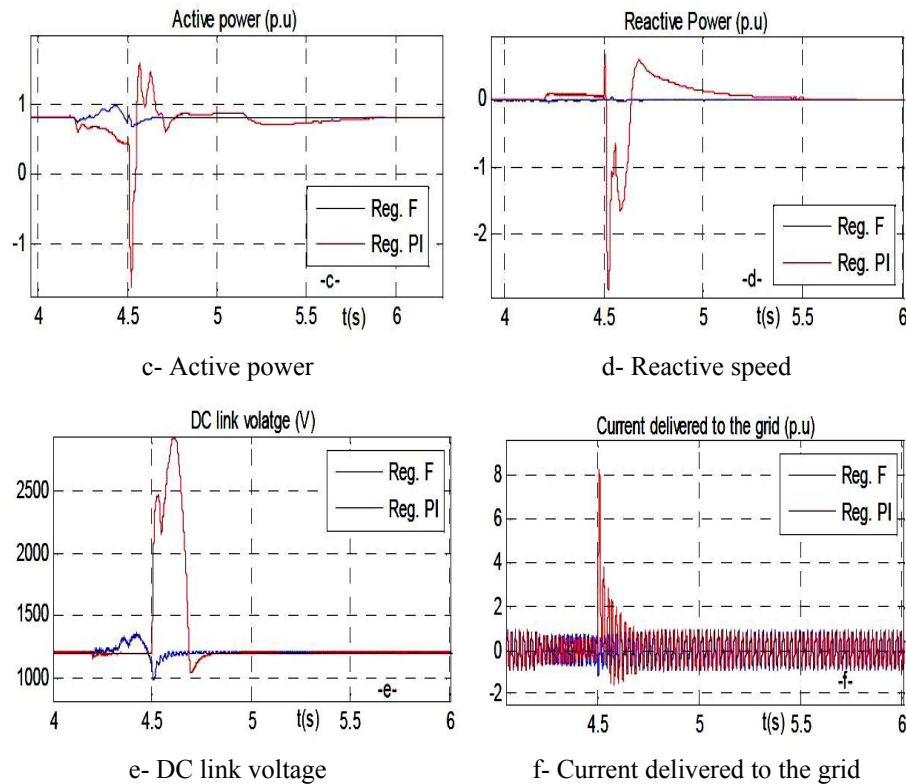

Fig. 16: 300 ms micro-interruption at the moment $t = 4.2$ s
Fuzzy logic controller (blue) and PI controller (Red)

Finally we can say that the structure suggested permits to wind turbine the toleration of micro-interruptions. So, it reduces wind turbine disconnections. The regulation of the rotor currents by using fuzzy logic controller improved the performance of the system during the appearance of the micro-interruptions fault.

7. CONCLUSION

To reach the maximum wind power extraction, wind turbine has to reduce their disconnection. For this reason grid operators impose, by their grid connection requirements, to wind turbine producer to support some grid disturbance. Doubly fed induction generators are more sensible to the grid disturbance compared to other kind of generator.

This paper has proposed a scheme allowing, a wind turbine based on DFIG, to avoid disconnection when micro interruption appears. A control strategy of the UPFC, using PI regulator, has been presented.

Finally a fuzzy logic controller was illustrated. Such controller performs well in transient mode of the DFIG. Especially for micro-interruption they reduce peak and duration of transient mode.

REFERENCES

- [1] K. Jemli, M.A. Dami, M. Jemli, M. Gossa and M. Boussak, 'Control of a Doubly Fed Induction Generator under Voltage Dips using Fuzzy Logic Controllers', International Review of Automatic Control, Vol. 1, N°4, pp. 458 – 465, November 2008.
- [2] T. Sun, Z. Chen and F. Blaabjerg, 'Voltage Recovery of Grid-Connected Wind Turbines with DFIG After a Short-Circuit Fault', IEEE, 35th Annual Power Electronics Specialists Conference, Aachen, Germany, 20-25 June, 2004.
- [3] I. Martinez de Alegria, J.L. Villate, J. Andreu, I. Gabiola and P. Ibañez, 'Grid Connection of Doubly Fed Induction Generator Wind Turbines: A Survey', European Wind Energy Conference (EWEC'04), London (Reino Unido), 2004 .
- [4] R. Cárdenas, R. Peña, J. Clare, G. Asher and J. Probooste, 'MRAS Observers for Sensorless Control of Doubly-Fed Induction Generators', IEEE Transaction on Power Electronics, Vol. 23, N°3, pp. 1075 – 1084, May 2008.
- [5] R. Pena, R. Cardenas, D. Sbarbaro and R. Blasco-Giménez, 'Variable Speed Grid Connected Induction Generator for Wind Energy System', Proceedings of the European Power Electronics and Applications Conference, 'EPE-99', Lausanne, Switzerland, 1999.
- [6] R. Datta and V.T. Ranganathan, 'Variable-Speed Wind Power Generation using Doubly Fed Wound Rotor Induction Machine – A Comparison with Alternative Schemes', IEEE Transaction on Power Electronics, Vol. 17, N°3, pp. 414 – 421, September 2002.
- [7] S. Bhowmik, R. Spee and J.H.R. Enslin, 'Performance Optimization for Doubly Fed Wind Power Generation System', IEEE Transactions on Industry Applications, Vol. 35, N°4, pp. 949 – 958, July/August 1999.
- [8] S.D. Rubira and M.D. McCulloch, 'Control Method Comparison Of Doubly Fed Wind Generators Connected to the Grid by Asymmetric Transmission Lines', IEEE Transaction on Power Electronics, Vol. 36, N°4, pp. 986 – 991, July/August 2000.
- [9] Wei Qiao, Wei Zhou, J.M. Aller, and R.G. Harley, 'Wind Speed Estimation Based Sensorless Output Maximization Control for a Wind Turbine Driving a DFIG', IEEE Transaction on Power Electronics, Vol. 23, N°3, pp. 1156 – 1169, May 2008.
- [10] C. Jauch, 'Stability and Control of Wind Farms in Power Systems', Ph.D Dissertation, Aalborg University, Risø National Laboratory, Denmark 2006.
- [11] H. Akagi and H. Sato, 'Control and Performance of a Doubly-Fed Induction Machine Intended for Flywheel Energy Storage System', IEEE Transaction on Power Electronics, Vol. 17, N°1, pp. 109 – 116, January 2002.
- [12] I. Boldea and S.A. Nasar, 'The Induction Machine Handbook', 950 p., CRC Press, 2002.
- [13] W. Hofmann and F. Okafor, 'Doubly-Fed Full-Controlled Induction Wind Generator for Optimal Power Utilization', Proceeding of 4th IEEE International Conference on Power Engineering and Drive Systems, Vol. 1, pp. 355 – 361, 22 – 25 October 2001.
- [14] J.L. Rodriguez-Amenedo, S. Arnalte and J.C. Burgos, 'Automatic Generation Control of a Wind Farm with Variable Speed Wind Turbines', IEEE Transactions on Energy Conversion, Vol. 17, N°2, pp. 279 – 284, June 2002.

- [15] P.K. Shadhu Khan and J.K. Chatterjee, '*Three-Phase Induction Generators: A Discussion on Performance*', Electric Machines and Power Systems, Vol. 27, N°8, pp. 813 – 832, 1999.
- [16] L.H Hansen, P.H. Madsen, F. Blaabjerg, H.C. Christensen, U. Lindhart and K. Eskildsen, '*Generator and Power Electronics Technology for wind Turbines*', Proceeding of the 27th Annual Conference of the IEEE Industrial Electronics Society, IECON'2001, Vol. 3, pp. 2000 - 2001, 29 Nov. 2001 – 02 Dec. 2001.
- [17] G. Saccomando, J. Svensson and A. Sannino, '*Improving Voltage Disturbance Rejection for Variable Speed Wind Turbines*', IEEE Transaction Energy Conversion, Vol. 17, N°3, pp. 422 – 428, September 2002.