



Revue des Sciences et Sciences de l'ingénieur
Journal of sciences and engineering sciences

ISSN 2170-0737 EISSN: 2600-7029

<https://www.asjp.cerist.dz/en/PresentationRevue/303>



PV array Control for MPPT Power Generation Under Partial Shading

*B.K. Oubbati¹, M. Boutoubat¹, M. Belkheiri¹, A. Rabhi²

¹Electronic department, Laghouat University, Algeria.

²MIS Laboratory, Picardie University, France.

Article history

Received: 2018-03-21

Accepted: 2020-01-21

Abstract

The aim of this paper is to use an intelligent method for the Maximum Power Point Tracking (MPPT) of a photovoltaic (PV) generation system under partial shading conditions. In fact, the MPPT is achieved by using the intelligent algorithm for finding the global maximum power point. This algorithm combines a traditional MPPT technique (perturb and observe (P&O)) with an artificial neural network (ANN) method. The main goal of this algorithm is to predict the global maximum power point. simulation results show the effectiveness of the algorithm under partial shading conditions.

Key words: *Neural Network; MPPT; Partial Shading; PV; Perturb & Observe Technique.*

Résumé

Le but de cet article est d'utiliser une méthode intelligente pour le suivi du Point à puissance maximale (MPPT) d'un système photovoltaïque (PV) soumis à des conditions d'ombrage partiel. Effectivement, Le MPPT est achevé en utilisant l'algorithme intelligent pour trouver le point de puissance maximale global. Cet algorithme combine une traditionnelle technique pour le fonctionnement en MPPT (P & O) avec un réseau neuronal artificiel (ANN). Le but principal de cet algorithme est la prédiction du point à maximum de puissance. Les résultats de simulation obtenus montrent l'efficacité de cet algorithme.

Mots-clés : *Réseau Neuronal Artificiel (ANN) ; MPPT ; Ombrage Partiel ; PV ; Perturber et observer.*

1. Introduction

The recent years have seen a growing interest in the research in the field of renewable energy sources, especially the solar energy which has remarkable advantages over traditional energy sources such as (oil, petrol). In addition, the Solar energy is one of the fastest fields of renewable. The power generated by PV modules depends on solar irradiation levels. So, a Maximum Power Point Tracking (MPPT) controller is required to ensure that the maximum power is generated.

There were several MPPT algorithms have been introduced in literature such as Perturbation and Observation (P&O) [1]; Incremental Conductance (IC) [2], Fuzzy Logic controller (FLC) [3] and Fractional short-circuit voltage (FSCV) [2].

These cited algorithms of MPPT strategy have been successfully demonstrated in tracking the MPP under uniform insolation where only one maximum power point (MPP) exists in the power-against – voltage (P-V) curve [4].

But, these classical algorithms become unsuccessfully to identify the Global Maximum Power Point (GMPP), when an uneven solar irradiance distribution along a string of the PV modules. One way to solve this is problem is the use of unconventional algorithms.

The work of this paper focusses on unconventional method to find the GMPP which combine a traditional MPPT strategy (P&O) and an artificial neural network (ANN) algorithm.

The scheme of the studied system is presented in Fig 1.

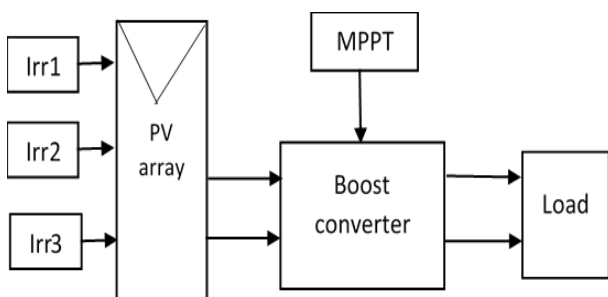

Figure.1, The layout of the studied system.

2. PV array modelling

The equivalent circuit of a PV cell is shown in Fig 2.

Where,

I_{ph} represents the cell photocurrent; R_{sh} and R_s are the intrinsic shunt and series resistances of the cell, respectively.

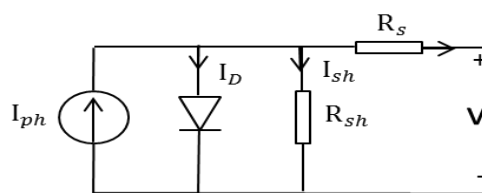

Figure 2, PV equivalent circuit.

The photocurrent I_{ph} is expressed by the following equation:

$$I_{ph} = [I_{sc} + K_i(T - 298)] \times I_r / 1000 \quad (1)$$

The reverse saturation current I_{rs} is given by:

$$I_{rs} = I_{sc} / [\exp\left(\frac{qV_{oc}}{N_s k n T}\right) - 1] \quad (2)$$

The saturated current I_0 that varies with the cell temperature, is expressed:

$$I_0 = I_{rs} \left[\frac{T}{T_r}\right]^3 \exp\left[\frac{qE_{g0}}{nk} \left(\frac{1}{T} - \frac{1}{T_r}\right)\right] \quad (3)$$

The output current of the PV is written as follow:

$$I = N_p \times I_{ph} - N_p \times I_0 \times \left[\exp\left(\frac{V/N_s + I \times R_s/N_p}{n \times V_t}\right) - 1\right] - I_{sh} \quad (4)$$

With,

$$V_t = \frac{k \times T}{q} \quad (5)$$

and

$$I_{sh} = \frac{V \times N_p / N_s + I \times R_s}{R_{sh}} \quad (6)$$

N_p : Number of PV modules connected in parallel;

N_s : Number of PV modules connected in serie;

R_s : Serie resistance (Ω);

R_{sh} : Shunt resistance (Ω);

V_t : Diode thermal voltage (V).

3. PV array model under partial shading

Generally, a PV array contains a large number of modules connected with each other in both Serie and parallel combinations. The PV can be under partial shading when, one of the PV modules is shaded or does not obtain enough solar irradiations [6]. Fig 3 shows the PV combined of three modules under partial shading (see fig 3 (a)). The obtained

simulated characteristics of the PV under partial shading is depicted in Fig.3 (b).

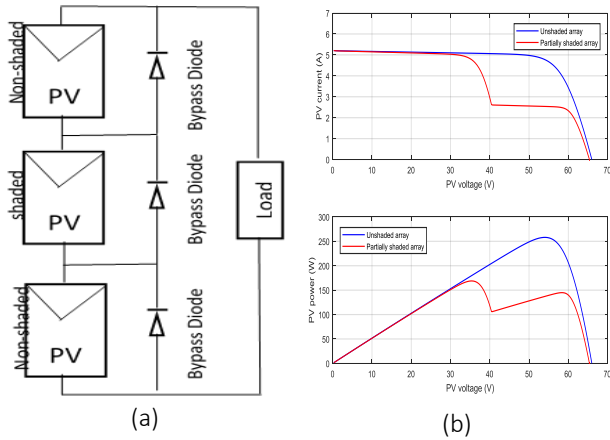

Figure 3, (a) PV array under partial shading. (b) PV array characteristics.

4. Hybrid MPPT method

In this study, a hybrid MPPT method, that combines the classical MPPT technique (P&O) with neural network artificial algorithm, is used to identify the Global Maximum Power Point (GMPP) of a PV array formed of three modules under partial shading. The control scheme of the studied system is presented in Fig.4

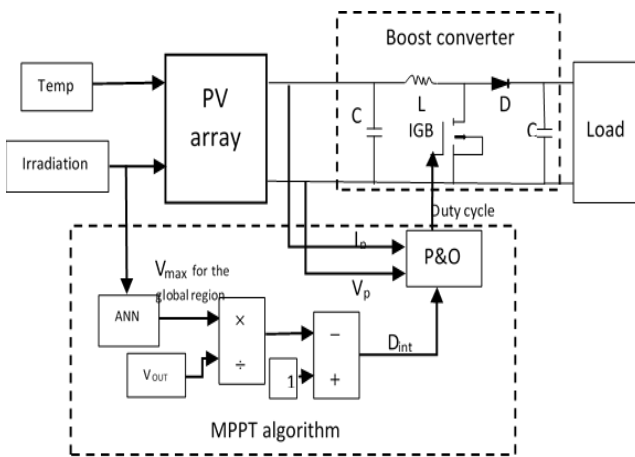

Figure 4, Control scheme of the PV array by using the hybrid MPPT method.

As has been mentioned previously, the classical MPPT based on (P&O) is used to track the MPP. In the following section, our efforts are focused on the development of ANN algorithm for finding the GMPP. The ANN algorithm is used for the determination of the region which contains the GMPP. The ANN in this system study consists of two layers followed with three different irradiance values for the three PV arrays. The output of the ANN is the maximum voltage of the region that corresponds to the GMPP. After the

determination of the maximum voltage which corresponds to the GMPP through the ANN algorithm, (P&O) intervenes to control the boost converter in order to provide the maximum power to the load.

5. Simulation Results and discussions

The obtained simulation results are presented in Fig (5 and 6), for fixed temperature of 25 C^o and three different irradiation values.

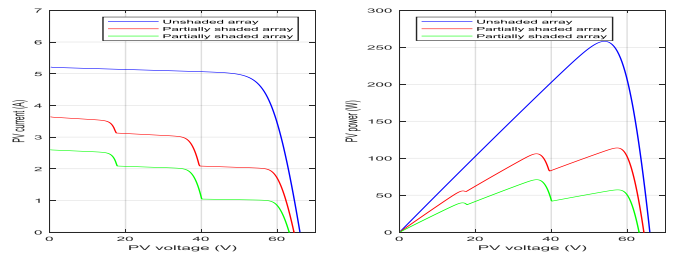
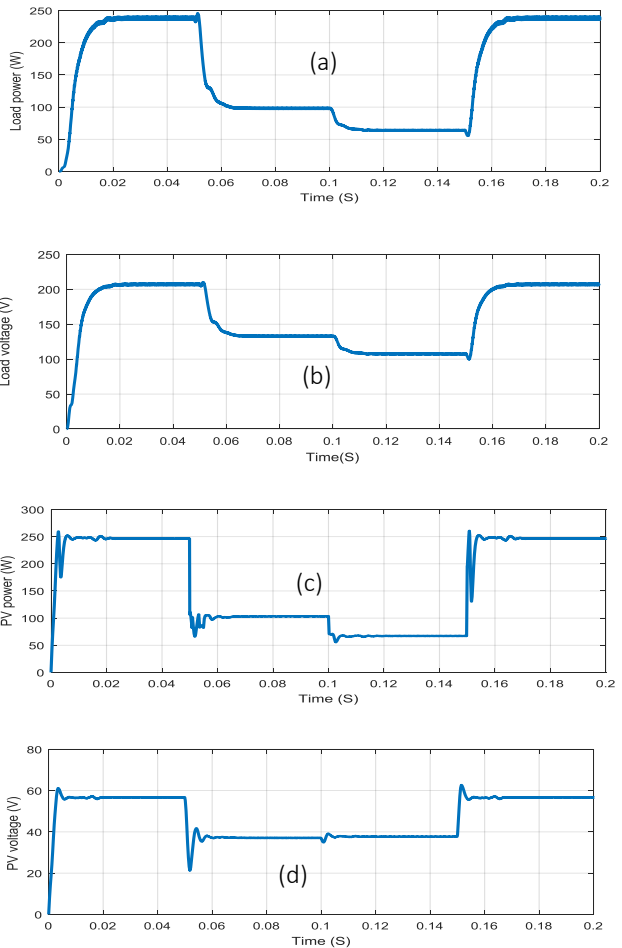

Fig .5, PV array characteristics under different shadings.



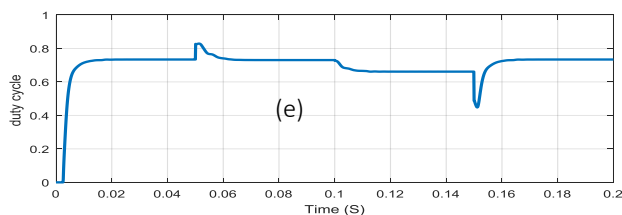

Figure 6. a) Load power (P_{load}) (W), b) Load voltage (V_{load}) (V), c) PV power (W), d) PV voltage (V), e) duty cycle (D).

From the obtained plots, one can remark that, the maximum power is reached in the three different cases which to different shading phenomena. In fact, in the case of unshaded PV array, the maximum power from the PV (250 W) (see Fig.6 (c)) is provided to the load (see Fig. (6 (a))). In the two other cases of shaded PV array, also, the maximum power is provided to the load (see Fig. 6 (a and b)). From Fig.6 (e), the duty cycle varies according to the different shading cases in such a way that the maximum power is transferred to the load. By comparing Fig.6 (a) and Fig. 6 (b), one can remark that the power load is less than the output PV. This difference is due to the system losses

6. Conclusion

This paper has focused on the study on the control of PV array under partial shading. In fact, a hybrid method composed from (P&O) strategy and ANN algorithm is used to find the GMPP through the ANN algorithm. After that, the (P&O) algorithm intervenes to control the boost converter in such a way the maximum power is provided to the load for different cases of shading phenomena. Noting that, the ANN algorithm was trained in an offline system. As perspectives, it is very important to propose a new algorithm in order to locate the GMPP online.

References

- [1] A. K. Abdelsalam, A. M, Massoud, S. Ahmed, and P. N. Enjeti , High-performance adaptive perturb and observe MPPT technique for photovoltaic- based microgrids .IEEE trans power electron , Apr.2011; 1010:1021–26 . no.4
- [2] T. Esmar and P. L. Chapman, "Comparison of photovoltaic array maximum power point tracking techniques," IEEE Trans. Energy Convers, Jun. 2007; 439:449–22, no. 2
- [3] B. N. Alajmi, K. H. Ahmed, S. J. Finney, and B. W. Williams, "Fuzzylogic-control approach of a modified hill-climbing method for maximum power point in microgrid standalone photovoltaic system," IEEE Trans. Power Electron, Apr. 2011; 1022:1030–26, no. 4
- [4] M. S. Ngan, and C. Wei Tan, A study of maximum power point tracking algorithms for stand-alone photovoltaic

systems. IEEE Applied Power Electronics Colloquium , (2011, April).

[5] L. L. Jiang, D. R. Nayanisiri, D. L. Maskell; and D. M. Vilathgamuwa. "A hybrid maximum power point tracking for partially shaded photovoltaic systems in the tropics," Renewable Energy. , Apr. 2015; 53:65-76.

[6] Hadi M.El-Helw, Ahmed Magdy ,Mostafa I. Marei , A Hybrid Maximum Power Point Tracking Technique for Partially Shaded Photovoltaic Arrays, IEEE Access, June 2017; 11900:11908-5