



Research Paper

## THE HIGHLIGHTING OF AN INTERNAL COMBUSTION ENGINE PISTON RING RADIAL OSCILLATIONS

La mise en évidence des oscillations radiales des segments de piston d'un moteur à combustion interne

**Djallel ZEBBAR<sup>a,\*</sup>, Kouider MOSTEFA<sup>a</sup>, Sahraoui KHERRIS<sup>a</sup>, Guillaume HOUZEAUX<sup>b</sup>**

<sup>a</sup>University Center El Wancharissi of Tissemsilt, BP 180 Tissemsilt 38000, Algeria

<sup>b</sup>Barcelona Supercomputing Center (BSC-CNS), Edificio NEXUS I, Gran Capitán 2-4, 08034 Barcelona, Spain

### ARTICLE INFO

*Historique de l'article:*

Reçu 11 mai 16

Accepté 02 juin 16

Keywords:

friction; hydrodynamic; lubrication oil; film thickness, piston ring

Mots clés:

frottement; hydrodynamique; lubrifiant; épaisseur du film, segment de piston

### ABSTRACT

This paper deals with the definition of the lube-oil film thickness in the piston ring cylinder liner junction of an internal combustion engine. At first, a mathematical model for the estimation of the film thickness is established. It is used to point out the oscillating motion of the piston ring normal to the cylinder wall. For the first time, has been highlighted and analytically evaluated the oscillating behavior of the piston ring in its housing in the radial direction. Furthermore, it is demonstrated that the radial oscillations frequency is a function of piston ring stiffness, material and geometry.

### RÉSUMÉ

Le présent travail a pour objectif l'étude du micro film de lubrification dans la jonction segment-chemise d'un moteur à combustion interne. Dans une première étape, un modèle mathématique pour l'estimation de l'épaisseur du microfilm de lubrification est élaboré. Il a permis de mettre en évidence pour la première fois le comportement oscillant du segment dans son logement dans le sens radial sous l'effet de la force élastique du segment et des pressions hydrodynamique du lubrifiant et aérodynamique des gaz. Ce qu'il faut retenir c'est que la fréquence d'oscillation du segment dans la direction radiale est fonction en premier lieu de la raideur du segment fonction à son tour du matériau du segment et des paramètres géométriques du segment de piston.

## 1 Introduction

The basic role of the piston ring is to seal the combustion chamber. This must be done in conjunction with a minimum of friction losses, wear and oil consumption for a relatively acceptable operating life. These large spots allocated to the piston ring gained the attention of several researches to which is added the present work devoted to the study of lubricating film in the piston ring cylinder liner junction of an internal combustion engine. The importance of such a study can be explained by the fact that over 50% of mechanical losses in an internal combustion engine are attributed to piston rings friction with nearly 60% of these losses are attributable to the first piston ring.

For a better understanding of all the tribological considerations in the piston ring cylinder liner junction, the study should first start by the examination of the sliding of flat plate on a viscous layer of lubricant.

\* Corresponding author. Tel.: +213 6 63464339

E-mail address: djallel.zebbar@gmail.com

The sliding of the plate, rather the motion of the viscous fluid between the two plane walls is governed by the Navier-Stokes equation discussed in detail in various references.

The hydrodynamic theory of lubrication and particularly mechanisms of lubricating film generation with all the ins and outs having an influence on the performance of the lubrication such as speed, load, temperature, etc ..., are sufficiently developed in the literature [1 et 2]. However, few are the works devoted specifically to the study of friction elements of the engine such as the manual of Petrishenko R.M. [3] and the research note of Andersson et al. [4].

Piston rings have a direct and significant influence on the sum of the mechanical losses in an internal combustion engine. According to [3 and 5] 60-70% of mechanical losses are attributed to the piston group friction with more than 60% of these losses are attributable to the first ring.

Moreover, according to many studies [6- 10] the performance in a lubricated contact is affected in terms of pressure build-up, film thickness and friction by surface roughness. Sahlin et al. [6] has presented an approach to generate flow factors that compensate for the surface roughness in the full film hydrodynamic regime by using the homogenized results of the compressible Reynolds equation. Dowson et al. [7] has demonstrated after examining of fourteen European diesel engines that lubrication in piston ring conjunction occur a few degrees after top dead centre and is governed by a conventional elastohydrodynamic mode of lubrication.

The importance of elastohydrodynamic effects in the lubrication of piston rings of modern gasoline and diesel engines has been investigated by J.E. Rycroft et al. [8]. According to this study in terms of frictional power losses, elastohydrodynamic effects are not significant in gasoline engines, but can be important in diesel engines.

Zhou et al. [9] have investigated oil film formation and friction force under rough surface conditions. They developed a model to simulate the effects of one dimensional roughness of the piston ring surface on lubrication and friction based on stochastic theory.

Wang et al. [10] have calculated the film thickness and pressure in line-contact elastohydrodynamic lubrication. They used the average Reynolds equation which includes the additional flow transport due to sliding on a rough surface.

Furthermore, the piston rings are heat vectors directed from the piston head, through the piston ring and then through lubricating film to the cylinder liner wall and from there, to the cooling system. Moreover, according to Ustinov A.N. [11], the heat dissipation due to piston ring friction by the mirror of the cylinder liner at some points of the cycle leads to the reverse flow of heat from the ring to the piston head. This finding was indeed demonstrated in previous work [12 and 13] by the use of the electro-thermal similarity. The presence of the piston ring friction prevents the passage of heat from the piston head toward the cylinder liner. This finding is clearly visible in Fig.1. It is reflected in the passage above the horizontal axis of thermal losses curves oriented from the gas towards the piston head in the presence of piston skirt and rings frictional forces. It must be noted that the three curves shown in Fig.1 correspond to three different cooling regimes of the piston expressed by the amount of heat conducted-out by the lubricating oil  $Q_{L.O}$ . equal to 0, 10 and 20 % of the total heat loss oriented from gas towards the piston head.

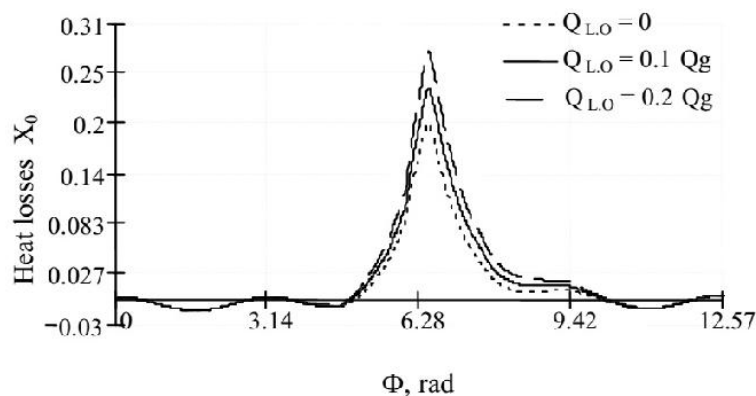

Fig.1– Ratio of the heat losses directed from the gas towards the piston head in the presence of piston ring and skirt frictions for three different cooling regimes [7]

According to the same authors [11 and 12] the amount of the stopped heat is equal to 30 and 18% for the non-cooled and cooled pistons consecutively.

Having said that part of the frictional heat at some point in the cycle is received by the piston head and this must be taken into account in the energy balance of the piston.

According to Furuhashi and Ichikawa [14] during full power operation of tow stroke air cooled engine the piston temperature can reach 350-370 ° C at its head center. In such circumstances the contact surface between the piston ring and cylinder liner and also the lubricating film operate in critical conditions which can accelerate their deterioration. Furthermore, the piston ring seals off the combustion chamber. This aspect known as piston ring conformability comes under dynamic sealing research area [15]. In the same context, Hans et al. claim in [16] that piston rings have a dominant influence on the gas leakage to the crankcase and on lube-oil consumption.

Moreover, a significant number of researches are dedicated to the experimental study of the lubricating film. Among which it is appropriate to quote Tamminen et al. [17] Sherrington and Smith [18, 19] Garcia-Atance Fatjo et al. [20] and Dhar et al. [21]. In [18, 19] Sherrington et al. present the full range of experimental methods used to measure lube-oil film thickness in the junction of piston ring and cylinder liner. According to the same authors capacitance method is the most appropriate for lube-oil film thickness measurement.

In addition, many mathematical models are established to define film thickness. In this context, it is appropriate to mention the work of Mittler R. et al. [22] in which authors give a physical description of the real ring and gas forces. Must be also mentioned the paper of Livanos and Kyrtatos [23] according to which a model is proposed to determine losses due to friction of the whole piston and piston rings.

For the first time, through this work is highlighted the oscillating behavior of the piston ring in its housing in the radial direction under the effect of the elastic force of the ring, lube-oil hydrodynamic force and gas pressures. Furthermore, a first valuation of the developed mathematical model is performed using data from a real four stroke diesel engine with a prime power  $N_e = 18.6$  kW and speed  $n = 1500$  rpm. At this stage of study, the review of the energy aspect is not intended and will be exhibited separately in other future work. That said, at this stage, it suffices to study the film hydrodynamic in the piston ring roughness free cylinder liner junction and highlight analytically for the first time, piston ring oscillating behavior in the radial direction reported before in [3 and 20].

## 2 Lube-oil film hydrodynamics

For the one-dimensional case shown in Fig.2, the governing equations of the film hydrodynamics can be deduced after consideration of an infinitesimal element of the fluid in the piston ring cylinder liner junction.

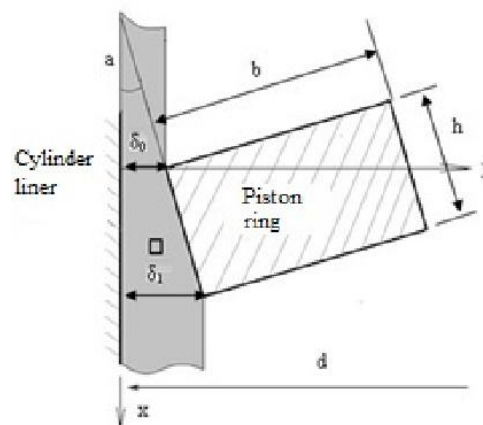

Fig.2 – Schematic representation of the piston ring cylinder liner junction

Without stopping too much on the details the following equation can be written:

$$\frac{\partial \tau_x}{\partial y} = \frac{\partial P}{\partial x} \quad (1)$$

In a parallel threads flow, the shear stress at a point is proportional to the velocity gradient perpendicular to the sliding plane, so: so:

$$\tau_x = \eta \frac{\partial u}{\partial y} \quad (2)$$

After substituting (2) into (1), the force equilibrium condition in the direction of x is obtained:

$$\frac{\partial P}{\partial x} = \eta \frac{\partial^2 u}{\partial y^2} \quad (3)$$

Assuming a constant pressure gradient, the successive double integration of the expression (3) gives:

$$u(x, y) = \frac{1}{2\eta} \frac{\partial P}{\partial x} y^2 + C_1 y + C_2 \quad (4)$$

For this last expression, the following boundary conditions can be established:

$$\begin{aligned} y=0 & : \quad u=0 \quad \text{and} \quad v=0 \\ y=\delta & : \quad u=u_s \quad \text{and} \quad v=v_s \end{aligned} \quad (5)$$

where:  $u_s$  and  $v_s$  are piston ring velocities in perpendicular and normal directions to the cylinder wall, successively.

The application of the previous boundary conditions allows one to obtain the following expression for the velocity  $u$ :

$$u(x, y) = \frac{1}{2\eta} \frac{\partial P}{\partial x} y^2 - \frac{1}{2\eta} \frac{\partial P}{\partial x} y \delta(x) + \frac{u_s}{\delta(x)} y \quad (6)$$

The system of equations must be complemented by the continuity equation:

$$\frac{\partial u}{\partial x} + \frac{\partial v}{\partial y} = 0 \quad (7)$$

and by the dynamic equilibrium equation applied to an arbitrary section of the piston ring:

$$\begin{aligned} m_s \frac{\partial v_s}{\partial t} &= \pi d h [P_{hyd} - P_g - P_{fr}] - k \delta \\ \frac{\partial v_s}{\partial t} &= \frac{\pi d h}{m_s} [P_{hyd} - P_g - P_{fr}] - \frac{k}{m_s} \delta \end{aligned} \quad (8)$$

The piston ring velocity in normal to the cylinder wall  $v_s$  can be expressed as a function of the displacement of the center of inertia of the piston ring section by the following expression:

$$\frac{\partial v_s}{\partial t} = \frac{\partial^2 \delta}{\partial t^2} \quad (9)$$

In expression (8)  $P_{fr}$  is the friction pressure at the contact of the piston ring and the bearing surfaces of the piston groove. It can be expressed as a function of gas pressure:

$$P_{fr} = f P_g \quad (10)$$

Where  $f$  is a friction coefficient equal to 0.2 for a wet cast-steel contact.

To solve the ordinary differential equations system composed of (8) and (9), we first must determine the hydrodynamic pressure and the ring stiffness coefficient  $k$ .

Moreover, hydrodynamic pressure can be determined from the following expression:

$$P_{hyd} = \frac{1}{h} \int_0^h P(x) dx \quad (11)$$

The pressure distribution over the entire height of the piston ring is determined from that of the flow rate expression  $Q$ :

$$Q = \int_0^{\delta(x)} u(x, y) dy = \text{const} \quad (12)$$

The integration of the expression (12) gives:

$$Q = \frac{u_s}{2} \cdot \delta(x) - \frac{1}{12} \cdot \frac{dP}{dx} \cdot [\delta(x)]^3 \quad (13)$$

Equation (13) allows bringing out  $P' = \frac{dP}{dx}$  as follows:

$$\frac{dP}{dx} = 12\eta \left[ \frac{u_s}{2[\delta(x)]^2} - \frac{Q}{[\delta(x)]^3} \right] \quad (14)$$

The pressure distribution in the junction is determined after the integration of the expression (14) which depends on Q, together with the following boundary conditions:  $x = h$  and  $P(h) = P_i$

Whence:

$$P(x) = 6\eta u_s \int_0^x \frac{dx}{[\delta(x)]^2} - 12\eta Q \int_0^x \frac{dx}{[\delta(x)]^3} + P_i \quad (15)$$

Where:  $P_i$  is the pressure in the piston ring motion direction.

In case of piston moving from top dead center (TDC) to bottom dead center (BDC),  $P_i$  is equal to the gas pressure in the enclosed space between the first and second rings  $P_1$ . Otherwise  $P_i$  is equal to the pressure above the piston, i.e. the gas pressure in the combustion chamber  $P_g$ . Pressures in question are both functions of the crankshaft rotation angle  $\varphi$ .

The pressure  $P(x)$  depends on the direction of piston movement which is in turn function of the crankshaft rotation angle  $\varphi$ .

The substitution of the boundary conditions into the expression (15) allows finding the following expression for the flow rate:

$$Q = \frac{P_g - P_1}{12\eta \int_0^h \frac{dx}{[\delta(x)]^3}} + \frac{1}{2} U_s \frac{\int_0^h \frac{dx}{[\delta(x)]^2}}{\int_0^h \frac{dx}{[\delta(x)]^3}} \quad (16)$$

Substituting the result in (15) makes (it) possible to deduce the hydrodynamic pressure  $P_{hyd}$  present in (8) as a function of  $P(x)$ :

$$P_{hyd} = \frac{1}{h} \int_0^h P(x) \quad (17)$$

This pressure is obviously a function of the crankshaft rotation angle. Therefore, to solve the system of differential equations (8) and (9), the stiffness coefficient  $k$  must be determined first. To do this, the piston ring section subject to a radial load must be examined, as shown in Fig.3.

This section moves radially at a distance  $y_0$  and undergoes simultaneously a rotation  $\theta$ . The resolution of such a problem is built on two key assumptions. The first assumes that the radial section of the ring remains undeformable. When the second suggests that the physical model of the ring consists of several washers linked to each other by elastic connections.

The ring relative elongation according to Berguer et al. [24] is determined from the following expression:

$$\frac{\theta_0}{r_0} = \frac{12 a_1 e q}{E b h} \quad (18)$$

$$\frac{y_0}{r_0} = \frac{a_1 q}{E h b} \quad (19)$$

Where:  $y_0$  is the displacement of the section center of inertia in the radial direction;  $\theta_0$  is a piston ring section rotation;  $E$  is the elasticity modulus of the piston ring;  $q$ - is the load in the radial direction N/m;  $r_0$  and  $b$  are geometrical parameters reported on the fig.3.

The ring section's rotation around its center of mass is not considered in this study, where the omission of the expression (18).

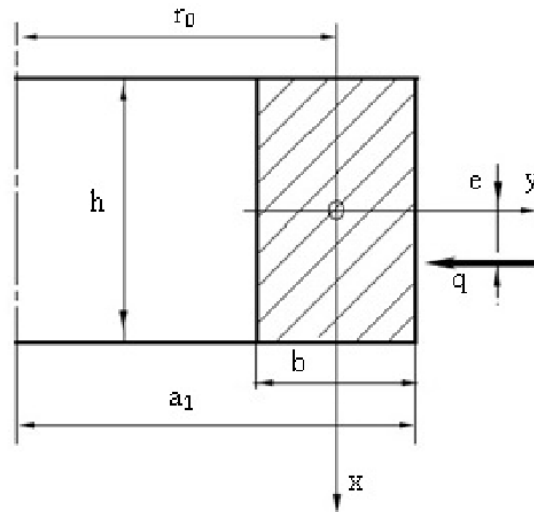

Fig.3 – Geometric parameters of the piston ring section required for the stiffness calculation

The load  $q$  in N/m reported in the expression (19) is calculated as the forces resultant  $\Sigma F$ , exerted on the ring and distributed over its entire circumference. This resultant force can be expressed as follows:

$$\Sigma F = ky_0$$

or equivalently

$$\frac{\Sigma F}{y_0} = \frac{q \pi d}{y_0} = k \quad (20)$$

The expression (19) is used to express the ratio  $q/y_0$  as follows:

$$\frac{q}{y_0} = \frac{E h b}{r_0 a_1} \quad (21)$$

Substituting  $r_0 = \frac{d}{2} - \frac{b}{2}$  and  $a_1 = \frac{d}{2}$  into (21) allows expressing  $\frac{q}{y_0}$  as follows:

$$\frac{q}{y_0} = \frac{E h b}{\left(\frac{d}{2} - \frac{b}{2}\right) \frac{d}{2}} = \frac{4 E h b}{(d-b) d} \quad (22)$$

For a ring subject to a pressure force uniformly distributed all around its circumference, the stiffness coefficient  $k$  can be expressed, after the substitution of the expression (22) into (20) by the following expression:

$$k = \frac{4\pi E b h}{d-b} \quad (23)$$

The resolving of the differential equation system (8) and (9) has allowed determining the variation of the thickness of the lube-oil film (Fig.4) and the piston ring radial speed  $v_s$  (Fig.5) depending on crankshaft rotation angle.

### 3 Results and discussion

The expression (6) allowed deducing fluid velocities profiles for all ring positions. Sketches of fluid velocities which are not presented here show the presence of a reverse flow in the near cylinder wall layers and must be checked later by a numerical simulation.

Furthermore, lube-oil film's thickness analysis shows that the piston ring makes oscillating movements around a certain value of thickness. A closely check of the curve represented in fig.4, i.e. by the changing of the temporal resolution of the  $x$ -axis (Figure 6), makes early mentioned oscillations clearly visible. A similar examination of the ring radial velocity plot represented in fig.7 confirms the radial oscillating movement of the piston ring.

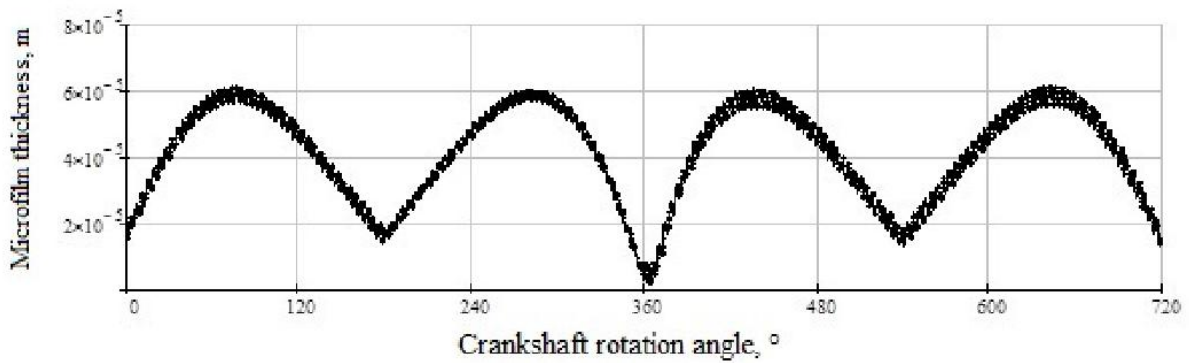

Fig.4 – Lube-oil film thickness variation during one cycle

The application of the adequate temporal resolution allows obtaining the results reported in the table 1. The variation of the elasticity modulus  $E$  from 85000 to 115000 N/mm<sup>2</sup> allowed deducing that the oscillation frequency increases from 1900 to 2200 Hz which is equivalent to 38-44 oscillations per 180 ° interval.

**Table 1 Results of piston ring parameters varying**

Parameter	Variation range	Oscillations frequency	Film thickness, $\delta$ ( $\mu\text{m}$ )
Elasticity modulus, $E$ (N/mm <sup>2</sup> )	85000..115000	1900..2200 (Hz)	80→61
Piston ring height , $h$ (mm)	1..3	1550..2650 (Hz)	40→82
Piston ring width , $b$ (mm)	2..4	1750..2500 (Hz)	84→45

Analogously, the oscillations frequency increases with the growth of the piston ring height. Furthermore, the variation of the ring height  $h$  in the range of 1..3 mm increases the oscillations frequency from 1550 to 2650 Hz which is equivalent to 31 - 53 oscillations over an interval of crankshaft rotation equal to 180 °.

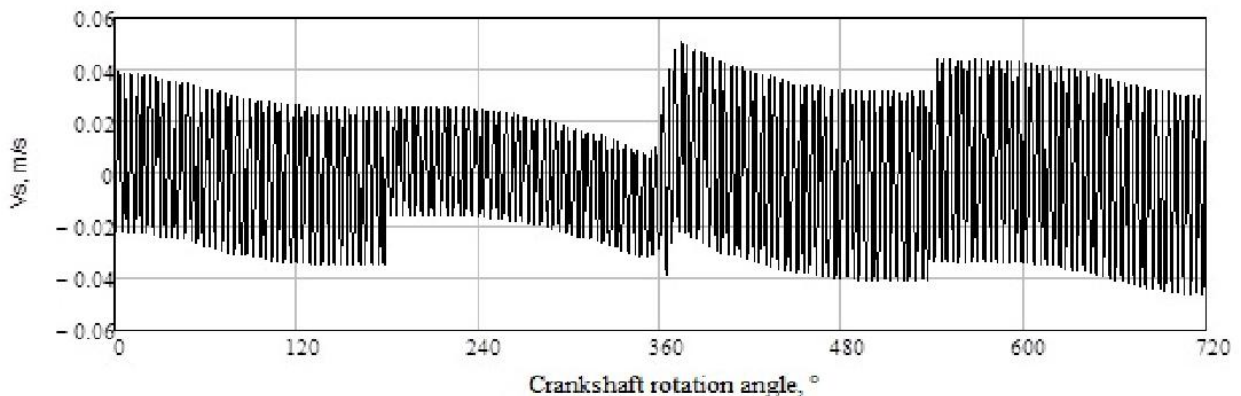

Fig.5 – The variation of the piston ring radial velocity during one cycle

However, the most significant parameter, which is the lube-oil film thickness in the piston ring cylinder liner junction, increases from 40 to 82  $\mu\text{m}$ , i.e. twice. Finally, the variation of the radial width of the piston ring from 2 to 4 mm induces a decrease of the film lube-oil maximum thickness from 84 to 45  $\mu\text{m}$ , with an increase of oscillations frequency on the same interval from 1750 to 2500 Hz, which is equivalent to 35 - 50 oscillations over the same interval.

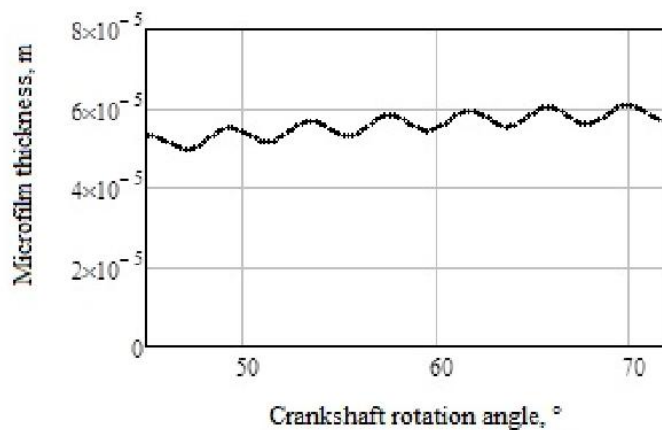

Fig.6 – The visualization of the ring film thickness with a higher temporal resolution

Another aspect of the lubrication is reported in [4] is related to the piston ring height effectively covered by the oil. The same authors state that 10 to 40% of the piston ring height is effectively covered by the lubricant. Moreover, the injection into the mathematical model of the effective height values in the range of (0.1-0.4) of the piston ring geometrical height ( $h$ ) allowed deducing that the maximum lube-oil film thickness is two times smaller and is approximately equal to  $30\ \mu\text{m}$ .

On the other hand the comparison of the variation of the lube-oil film thickness curve with that obtained by Zhou Quan-bao et al. [9], Ming-Tang Ma et al. [25], Morris N. et al. [26] and those obtained by other authors shows a very close similarity of the traces, except for oscillations frequency which is one hundred times greater than the piston velocity.

Moreover, the unavoidable radial ring oscillation in its groove may well cause wear of the two bearing surfaces of the piston groove. According to Sjodin and Olofsson [27], this wear could be ten times greater than that of the ring.

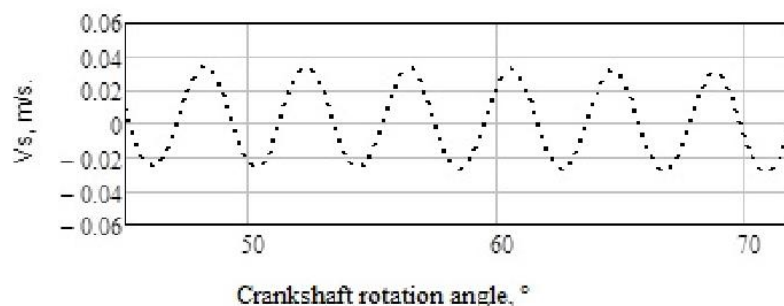

Fig.7 – The visualization of the ring radial velocity with a higher temporal resolution

## 4 CONCLUSION

This study allowed identifying a reverse flow near the cylinder wall layers. In real conditions, the thickness of reverse flow layer is of the order of asperity heights. On the other hand, the radial oscillation was not taken into account in the calculations at this first stage. So it should be taken into account in a more accurate mathematical model.

Furthermore, it should be noted that the ring oscillations frequency in the radial direction is depending primarily on the ring stiffness which is depending in turn on the ring material and geometric parameters.

This unavoidable radial ring oscillation could cause wear of the two bearing surfaces of the piston groove. According to [21], this wear could be ten times greater than that of the piston ring.

Finally, the study has demonstrated that the lube-oil film parameters and in particular its thickness and consequently the friction can be handled directly by the choice of the geometric parameters of the piston ring.



Finally, it should be emphasized that the proposed mathematical model has allowed to determine that the maximum thickness varies between 2 and 30  $\mu\text{m}$  for this concrete diesel engine which is in very good agreement with those reported by Tamminen et al. in [17], that are between 2 and 20  $\mu\text{m}$  for the first piston ring cylinder liner junction in full power regime.

## REFERENCES

- [1] H. Schlichting, *Theory of boundary layer*, Transl. by J. Kestin, 7th ed. McGraw-Hill Series in Mechanical Engineering, New York, 1979.
- [2] G.W. Stachowiak and A.W. Batchelor, *Engineering Tribology*, Butterworth-Heinemann, 2001.
- [3] R.M. Petrishenko, A.B. Kanishev and A.U. Shabanov, *Friction and heat transfer of piston rings of internal combustion engines*, Leningrad University, Leningrad, 1990.
- [4] P. Andersson, J. Tamminen and C.E. Sandström, *Piston ring tribology, A literature survey*, VTT Research Notes 2178, Espoo: VTT Tiedotteita, 2002.
- [5] R.M. Petrishenko and V.V. Onosovski, *Cycles of reciprocal engines*, Mashinostrojenja, Leningrad, 1972.
- [6] F. Sahlin, A. Almqvist, R. Larsson and S. Glavatskih, *Rough surface flow factors in full film lubrication based on a homogenization technique*, *Tribology International* 40 (2007) 1025–1034.
- [7] D. Dowson, B. L. Ruddy and P. N. Economou, *The elastohydrodynamic lubrication of piston ring*, *Proceedings of the Royal Society of London, Series A, Mathematical and Physical Sciences*, 386(1791) (1983) 409-430.
- [8] J.E. Rycroft, R.I. Taylor and L.E. Scales, *Elastohydrodynamic Effects in Piston Ring Lubrication in Modern Gasoline and Diesel Engines*, *Tribology And Interface Engineering Series* 32 (1997) 49-54.
- [9] Zhou Quan-bao, Zhu Tie-zhu and Wang Rong-sheng, *A full lubrication model for rough surface piston rings*, *TRIBOLOGY international* 21(4) (1988) 211-214.
- [10] [D.-S. Wang and J.-F. Lin, *Effect of surface roughness on elastohydrodynamic lubrication of line contacts*, *Tribology International* 24(1) (1991) 51-62.
- [11] A.N. Ustinov, *Study of diesel engines piston ring*, Saratov University, 1974.
- [12] Dj. Zebbar, *Study and elaboration of a methodology of determination of thermal state of cylinder group elements in marine diesel engine*, Ph.D. thesis, Astrakhan technical State University, Astrakhan, 2005.
- [13] Dj. Zebbar and A. Zebbar, *Mathematical modeling of the instantaneous and quasi static heat flux resulting from friction of the piston rings and the definition of the hydrodynamic film thickness in the piston ring cylinder liner junction taking into account mechanical losses*, *Vestnik of Voronej State Technical University*, T.2(8) (2006) 68-70.
- [14] S. Furuhashi and H. Ichikawa, *L-Ring Effect on Air-Cooled Two-Stroke Gasoline Engines*, N.Y.: Society of Automotive Engineers 730188.
- [15] V. Dunaevsky and S. Alexandrov, *Three-Dimensional Engineering Approach to Conformability Analysis of Piston Rings*, *Tribology Transactions* 48 (2005) 108-118.
- [16] [16] H. Priebisch Hans and M. Herbst Hubert, *Simulation des Einflusses von Kolbenringparametern*, *MTZ - Motortechnische Zeitschrift* 60(11) (1999) pp 772-779.
- [17] J. Tamminen, C.E. Sandström and P. Andersson, *Influence of load on the tribological conditions in piston ring and cylinder liner contacts in a medium-speed diesel engine*, *Tribology International* 39 (2006) 1643–1652.
- [18] I. Sherrington and E.H. Smith, *Experimental methods for measuring the oil-film thickness between the piston-rings and cylinder-wall of internal combustion engines*, *Tribology International* 18(6) (1985) 315–320.
- [19] I. Sherrington, *Oil film thickness measurement: a contribution to the understanding and control of lubrication in the piston-ring packs of IC engines*, *J. of Engineering Tribology* 225(7) (2011) 595-601.
- [20] Fatjo G. Garcia-Atance, E.H. Smith and I. Sherrington, *Mapping lubricating film thickness, film extent and ring twist for the compression-ring in a firing internal combustion engine*, *Tribology International* 70 (2014) 112–118.
- [21] A. Dhar, A.K. Agarwal and V. Saxena, *Measurement of dynamic lubricating oil film thickness between piston ring and liner in a motored engine*, *Sensors and Actuators A: Physical* 149 (2009) 7–15.
- [22] R. Mittler, A. Mierbach and D. Richardson, *Understanding the fundamentals of piston ring axial motion and twist and the effects on blow-by*, *Proceedings of the ASME Internal Combustion Engine Division (ICES2009)*, 2009.
- [23] G. A. Livanos and N. P. Kyrtatos, *Friction model of a marine diesel engine piston assembly*, *Tribology International* 40 (2007) 1441–1453.
- [24] I.A. Berguer, B.F. Chorr and G.B. Iossilivish, *Strength calculation of machine parts*, Mashinostrojenij, Moscou,

1993.

- [25] Ma Ming-Tang, I. Sherrington, E. H. Smith and N. Grice, Development of a detailed model for piston-ring lubrication in IC engines with circular and non-circular cylinder bores, *Tribology International* 30(11) (1997) 779–788.
- [26] N. Morris, R. Rahmani, H. Rahnejat, P.D. King and B. Fitzsimons, Tribology of piston compression ring conjunction under transient thermal mixed regime of lubrication, *Tribology International* 59 (2013) 248 – 258.
- [27] U.I. Sjodin and U.L.-O. Olofsson, Experimental study of wear interaction between piston ring and piston groove in a radial piston hydraulic motor, *Wear* 257 (2004) 1281–1287.